

# SHINDENGEN

## Darlington Transistor

**2SB1283**  
(TP7J10)

- 7 A PNP

### OUTLINE DIMENSIONS

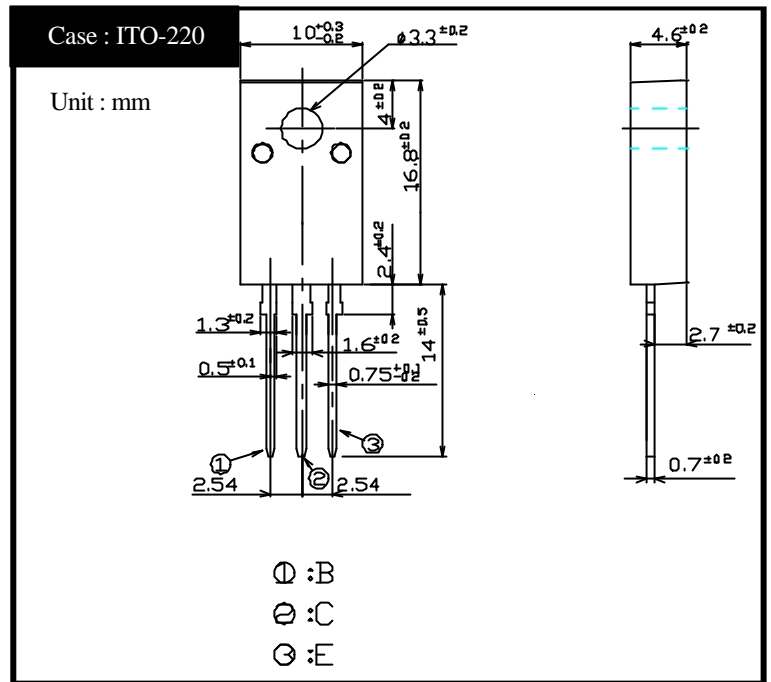

### RATINGS

#### Absolute Maximum Ratings

Item	Symbol	Conditions	Ratings	Unit
Storage Temperature	T <sub>stg</sub>		-55 ~ +150	
Junction Temperature	T <sub>j</sub>		+150	
Collector to Base Voltage	V <sub>CB0</sub>		-100	V
Collector to Emitter Voltage	V <sub>CEO</sub>		-100	V
Emitter to Base Voltage	V <sub>EBO</sub>		-7	V
Collector Current DC	I <sub>C</sub>		-7	A
Collector Current Peak	I <sub>CP</sub>		-10	A
Base Current DC	I <sub>B</sub>		-0.5	A
Base Current Peak	I <sub>BP</sub>		-1	A
Total Transistor Dissipation	P <sub>T</sub>	T <sub>c</sub> = 25	30	W
Dielectric Strength	V <sub>dis</sub>	Terminals to case AC 1 minute	2	kV
Mounting Torque	TOR	(Recommended torque : 0.3N·m )	0.5	N·m

#### Electrical Characteristics (T<sub>c</sub>=25 )

Item	Symbol	Conditions	Ratings	Unit
Collector Cutoff Current	I <sub>CBO</sub>	V <sub>CB</sub> = -100V	Max -0.1	mA
	I <sub>CEO</sub>	V <sub>CE</sub> = -100V	Max -0.1	
Emitter Cutoff Current	I <sub>EBO</sub>	V <sub>EB</sub> = -7V	Max -5	mA
DC Current Gain	h <sub>FE</sub>	V <sub>CE</sub> = -3V, I <sub>C</sub> = -3A	Min 1,500	
			Max 15,000	
Collector to Emitter Saturation Voltage	V <sub>CE(sat)</sub>	I <sub>C</sub> = -3A	Max -1.5	V
Base to Emitter Saturation Voltage	V <sub>BE(sat)</sub>	I <sub>B</sub> = -5mA	Max -2.0	V
Thermal Resistance	θ <sub>jc</sub>	Junction to case	Max 4.16	/W
Transition Frequency	f <sub>T</sub>	V <sub>CE</sub> = 10V, I <sub>C</sub> = 0.7A	TYP 20	MHz
Turn on Time	t <sub>on</sub>	I <sub>C</sub> = -3A I <sub>B1</sub> = I <sub>B2</sub> = -5mA R <sub>L</sub> = 10 V <sub>BB2</sub> = -4V	Max 1	μs
Storage Time	t <sub>s</sub>		Max 4	
Fall Time	t <sub>f</sub>		Max 2	

# 2SB1283 Saturation Voltage

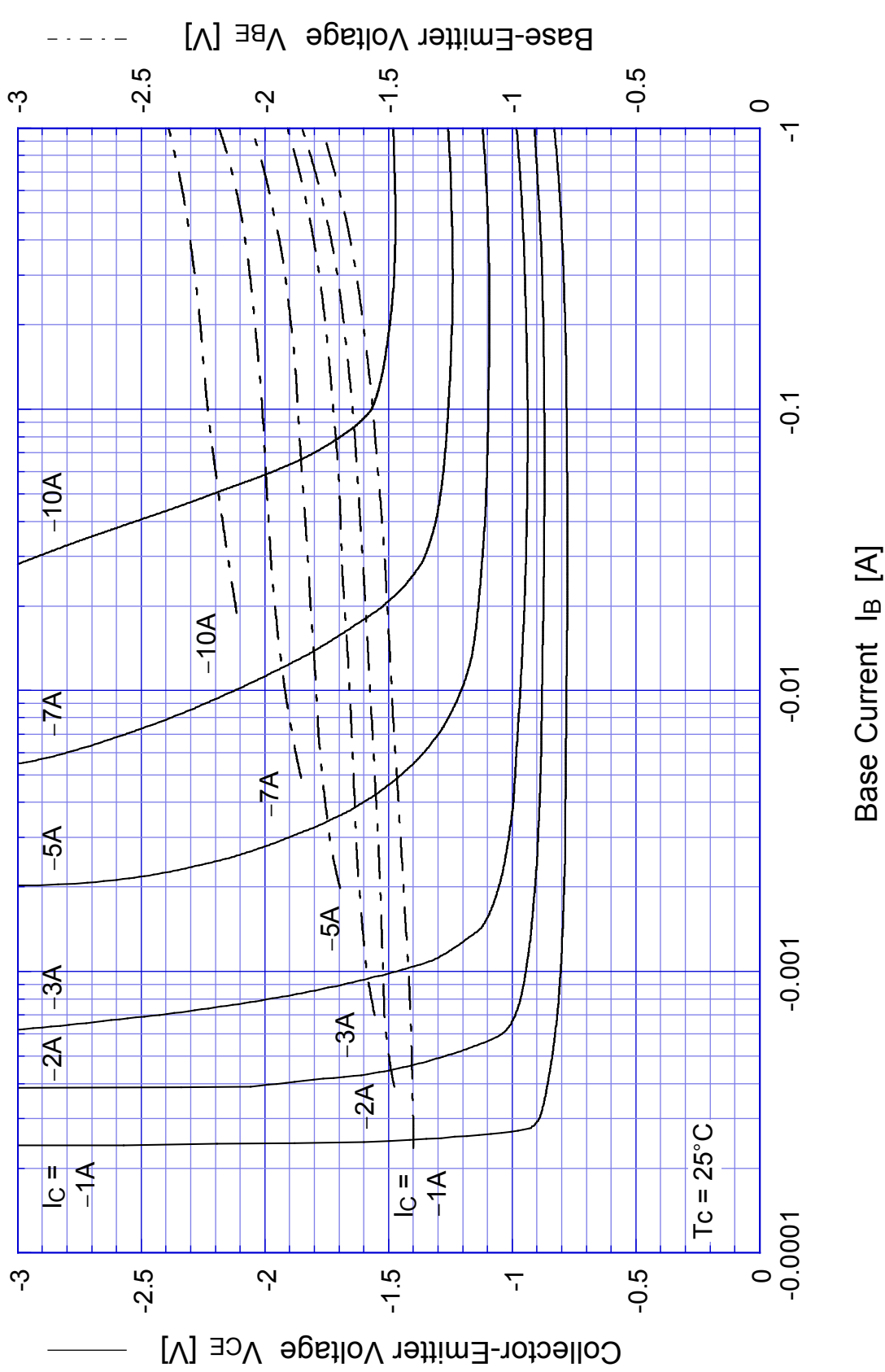

# 2SB1283

## Switching Time - $I_C$

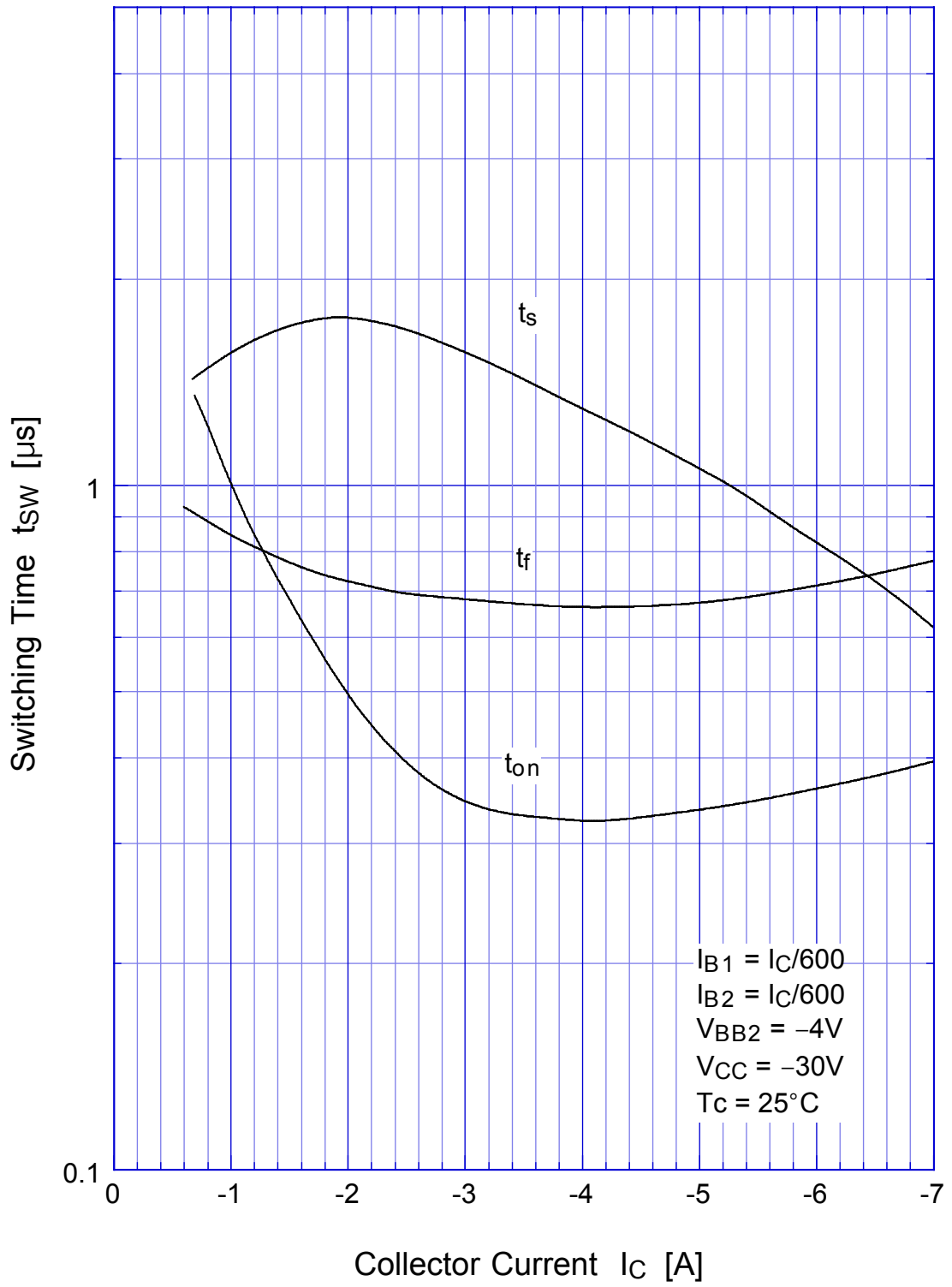

# 2SB1283

## Switching Time - Tc

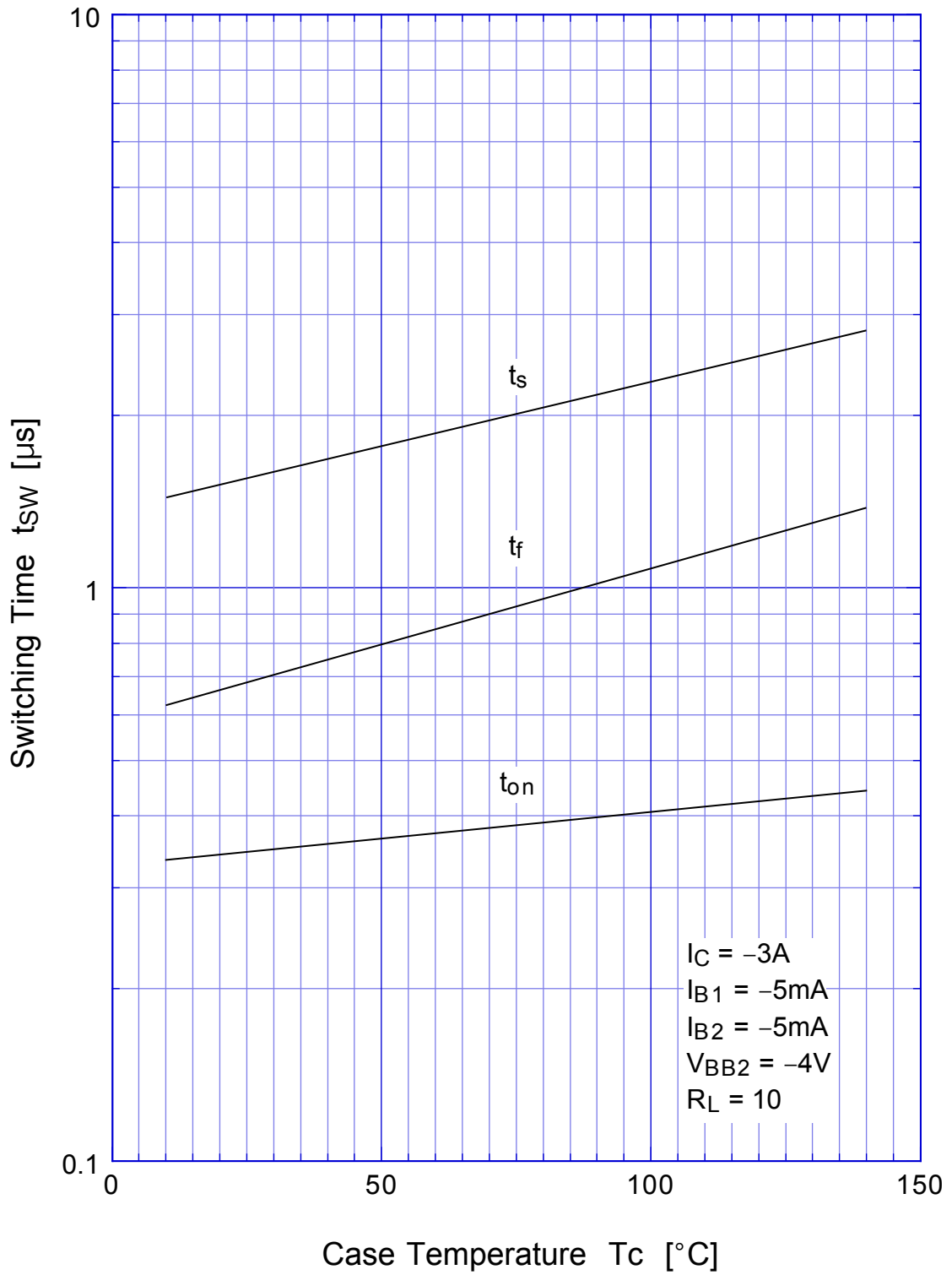

# 2SB1283 Transient Thermal Impedance

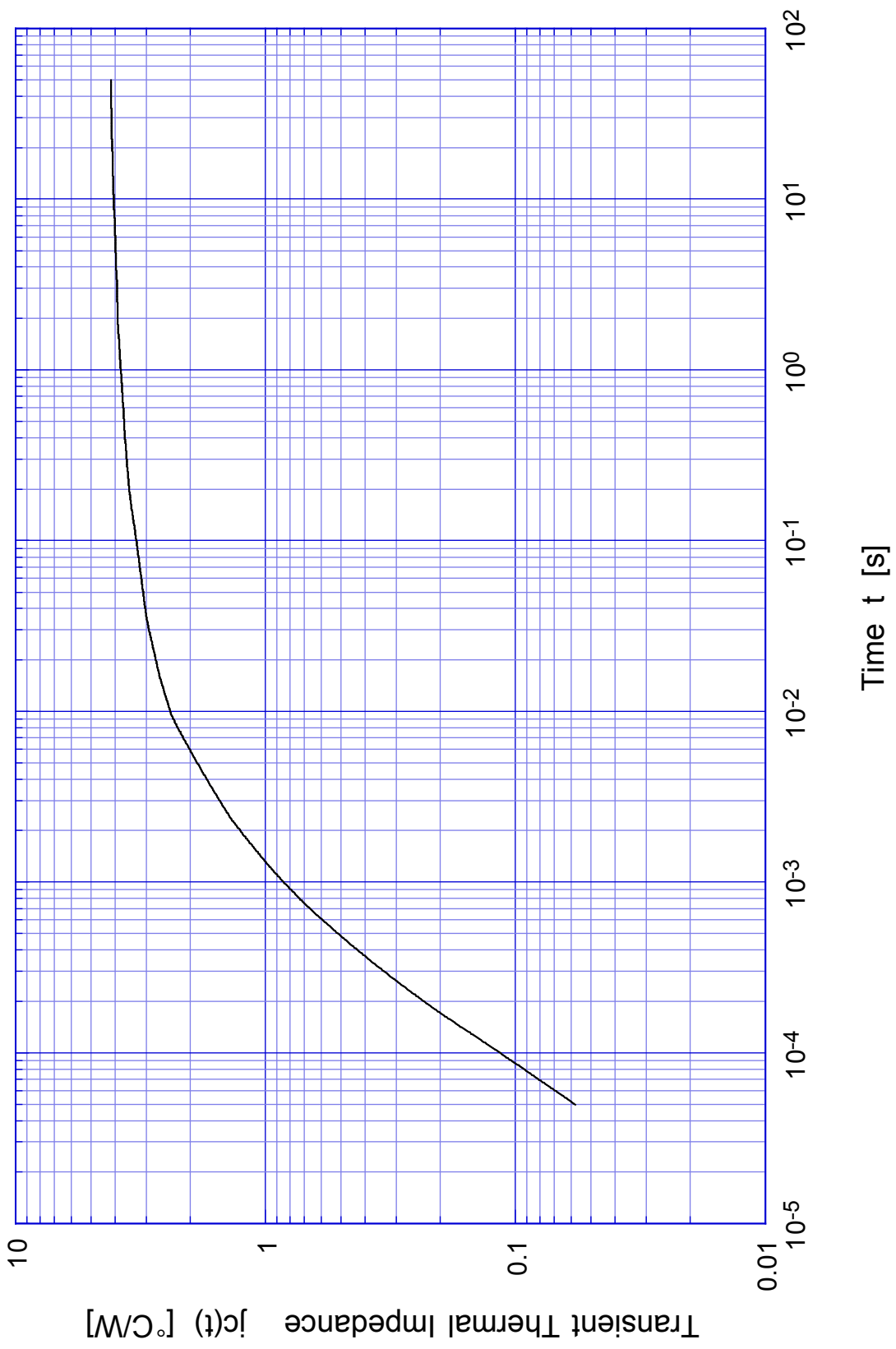

# 2SB1283

# Forward Bias SOA

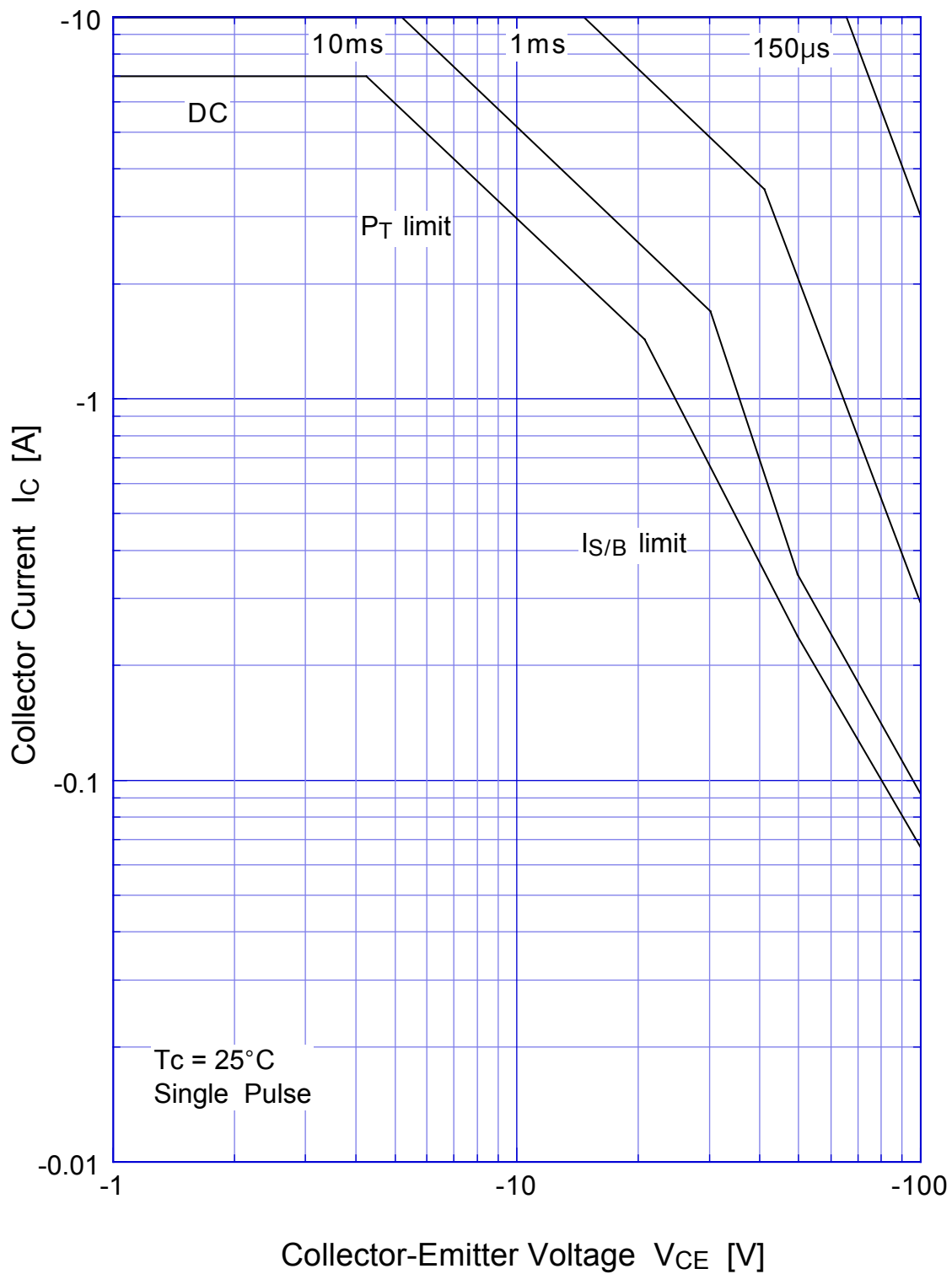

# 2SB1283 Collector Current Derating

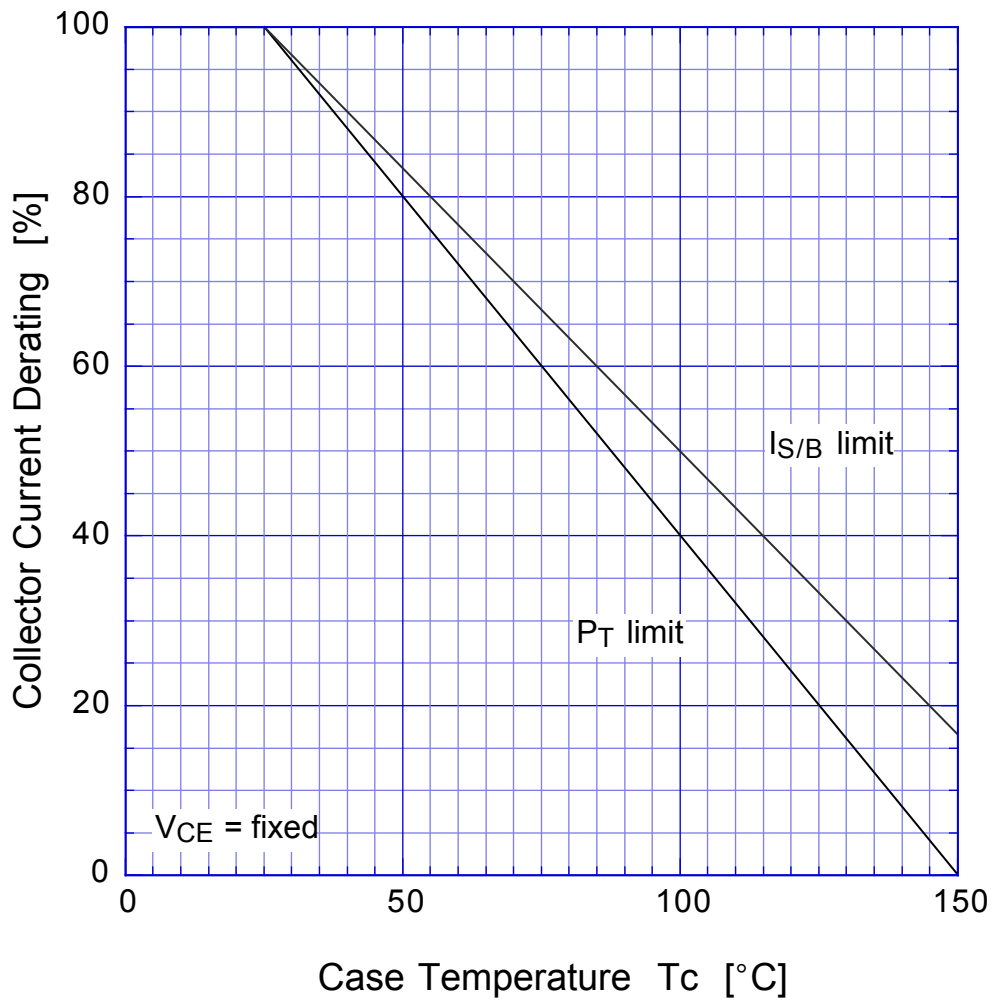

2SB1283

Reverse Bias SOA

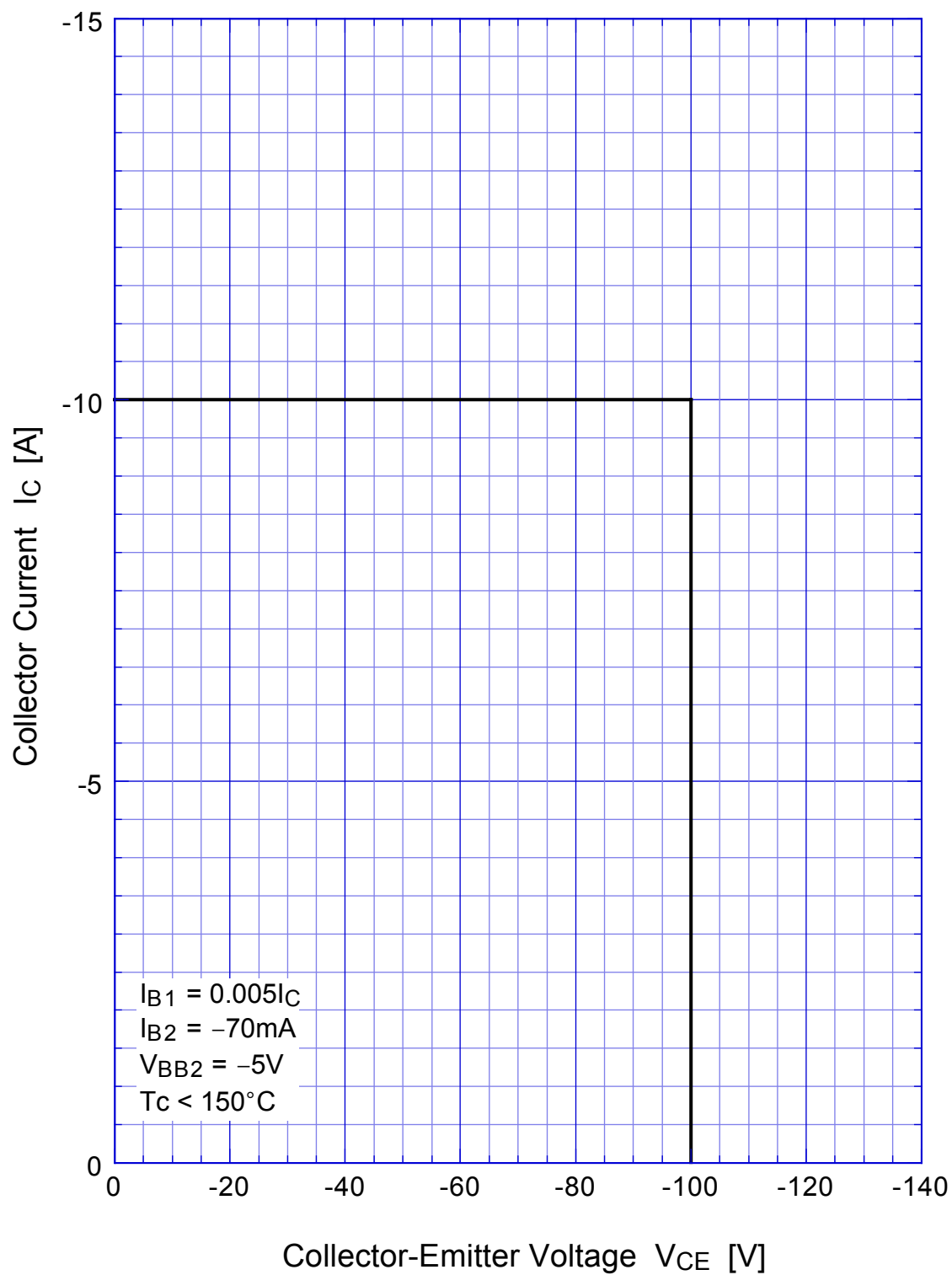



# 2SB1283

# Derating Curve

