

SHINDENGEN

Darlington Transistor

2SB1448
(TP15J10)

-15A PNP

OUTLINE DIMENSIONS

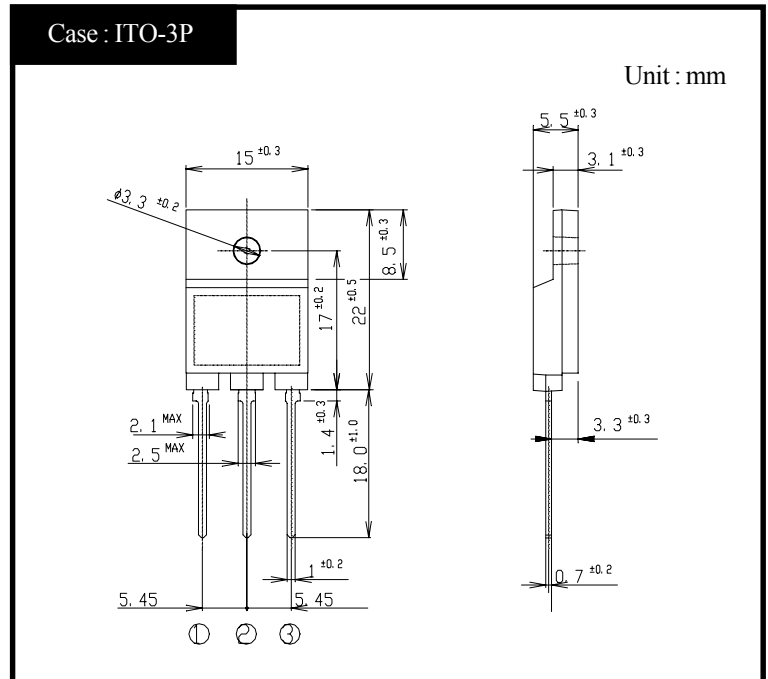

RATINGS

● Absolute Maximum Ratings

Item	Symbol	Conditions	Ratings	Unit
Storage Temperature	T _{stg}		-55~+150	°C
Junction Temperature	T _j		+150	°C
Collector to Base Voltage	V _{CB0}		-100	V
Collector to Emitter Voltage	V _{CEO}		-100	V
Emitter to Base Voltage	V _{EBO}		-7	V
Collector Current DC	I _C		-15	A
Collector Current Peak	I _{CP}		-22	A
Base Current DC	I _B		-1	A
Base Current Peak	I _{BP}		-2	A
Total Transistor Dissipation	P _T	T _c = 25°C	65	W
Dielectric Strength	V _{dis}	Terminals to case AC 1 minute	2	kV
Mounting Torque	TOR	(Recommended torque : 0.5N·m)	0.8	N·m

● Electrical Characteristics (T_c=25°C)

Item	Symbol	Conditions	Ratings	Unit
Collector Cutoff Current	I _{CB0}	V _{CB} = -100V	Max -0.1	mA
	I _{CEO}	V _{CE} = -100V	Max -0.1	
Emitter Cutoff Current	I _{EBO}	V _{EB} = -7V	Max -5	mA
DC Current Gain	h _{FE}	V _{CE} = -3V, I _C = -10A	Min 1,500	
			Max 15,000	
Collector to Emitter Saturation Voltage	V _{CE(sat)}	I _C = -10A	Max -1.5	V
Base to Emitter Saturation Voltage	V _{BE(sat)}	I _B = -20mA	Max -2.0	V
Thermal Resistance	θ _{jc}	Junction to case	Max 1.92	°C/W
Transition Frequency	f _T	V _{CE} = -10V, I _C = -1.5A	TYP 20	MHz
Turn on Time	ton		Max 1	μs
Storage Time	ts	I _C = -15A I _{B1} = I _{B2} = -20mA R _L = 2Ω	Max 4	
Fall Time	tf	V _{BB2} = -4V	Max 2	

2SB1448

$h_{FE} - I_C$

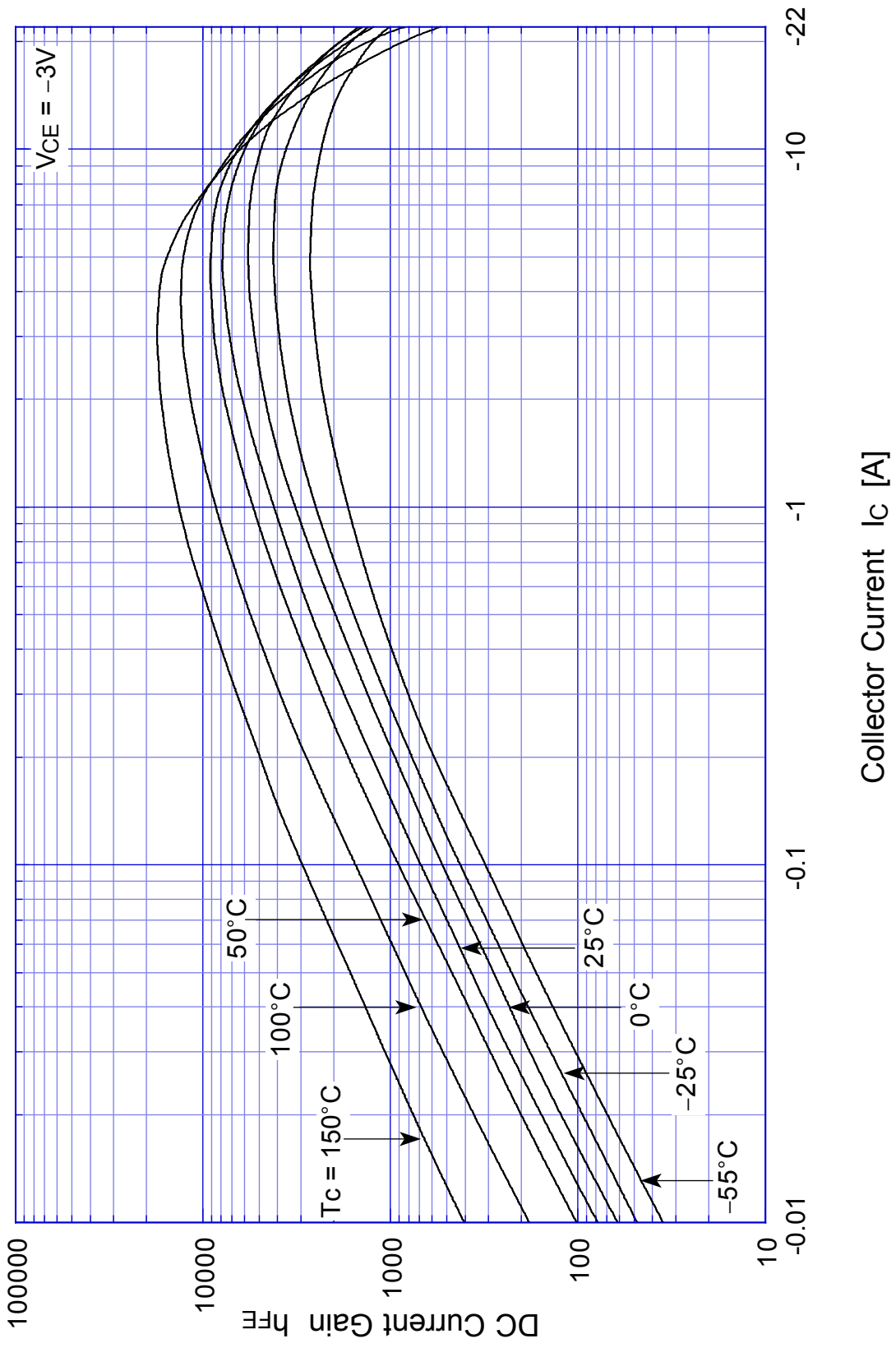

2SB1448 Saturation Voltage

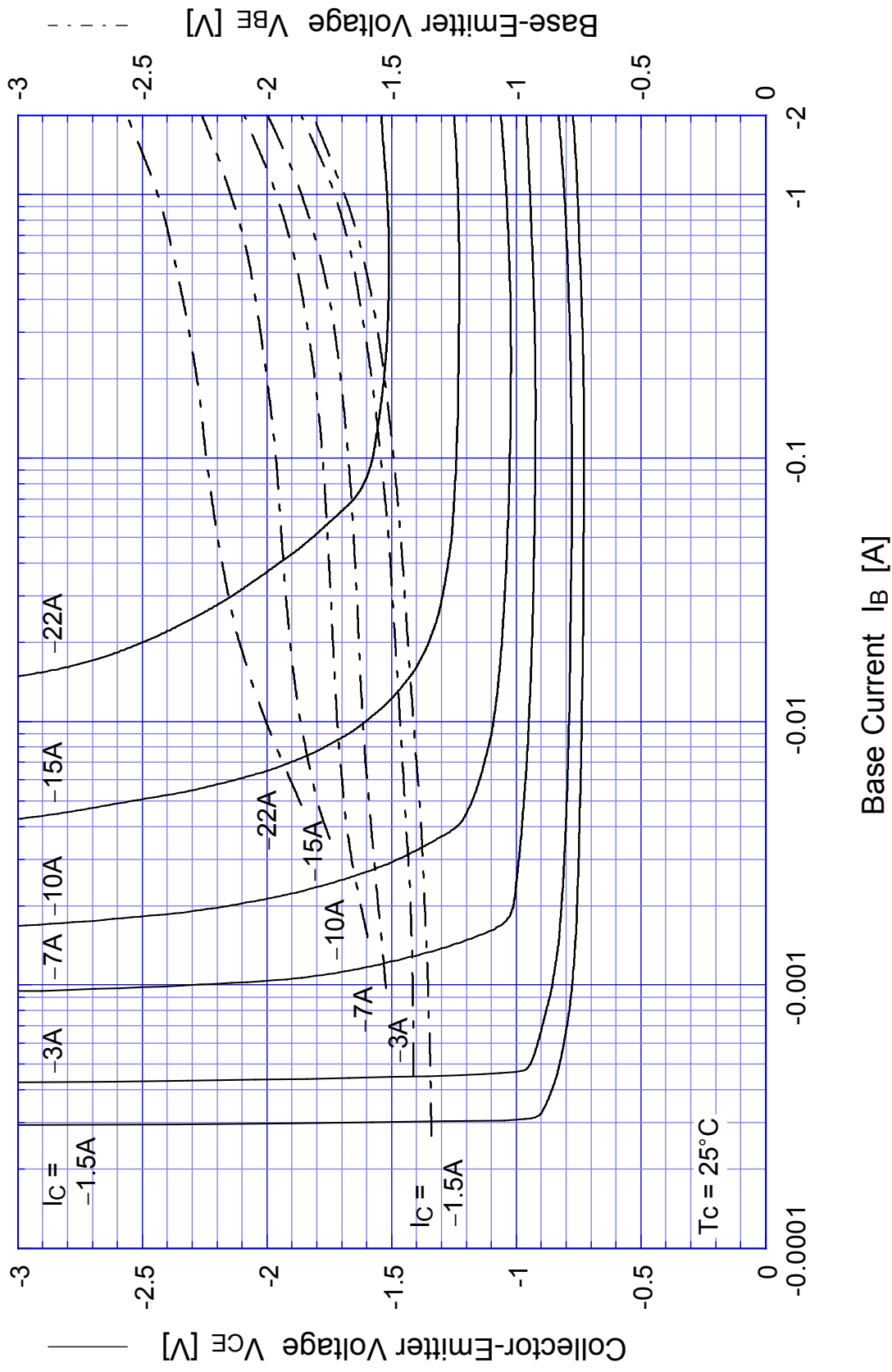

2SB1448

Switching Time - I_C

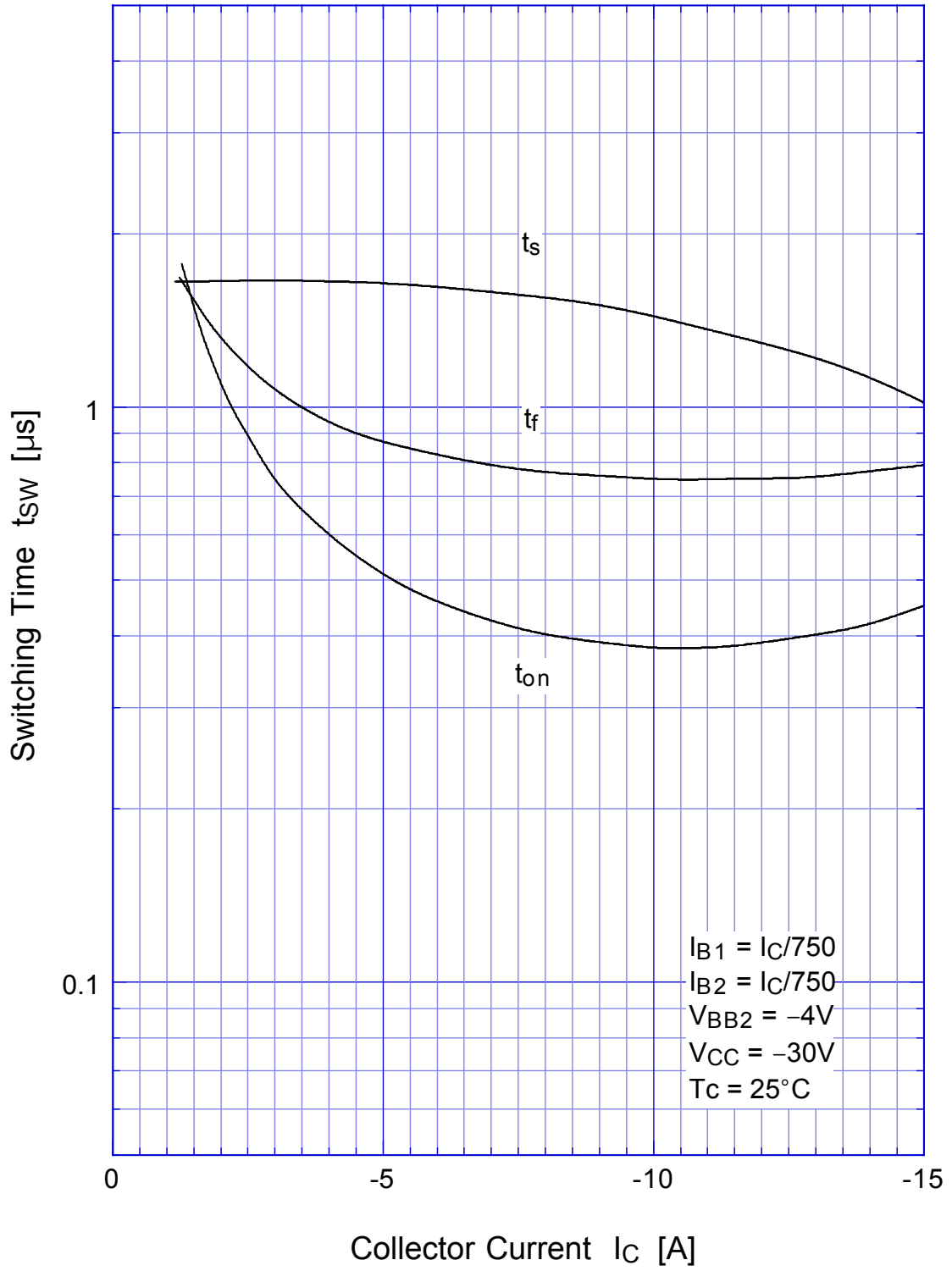

2SB1448

Switching Time - Tc

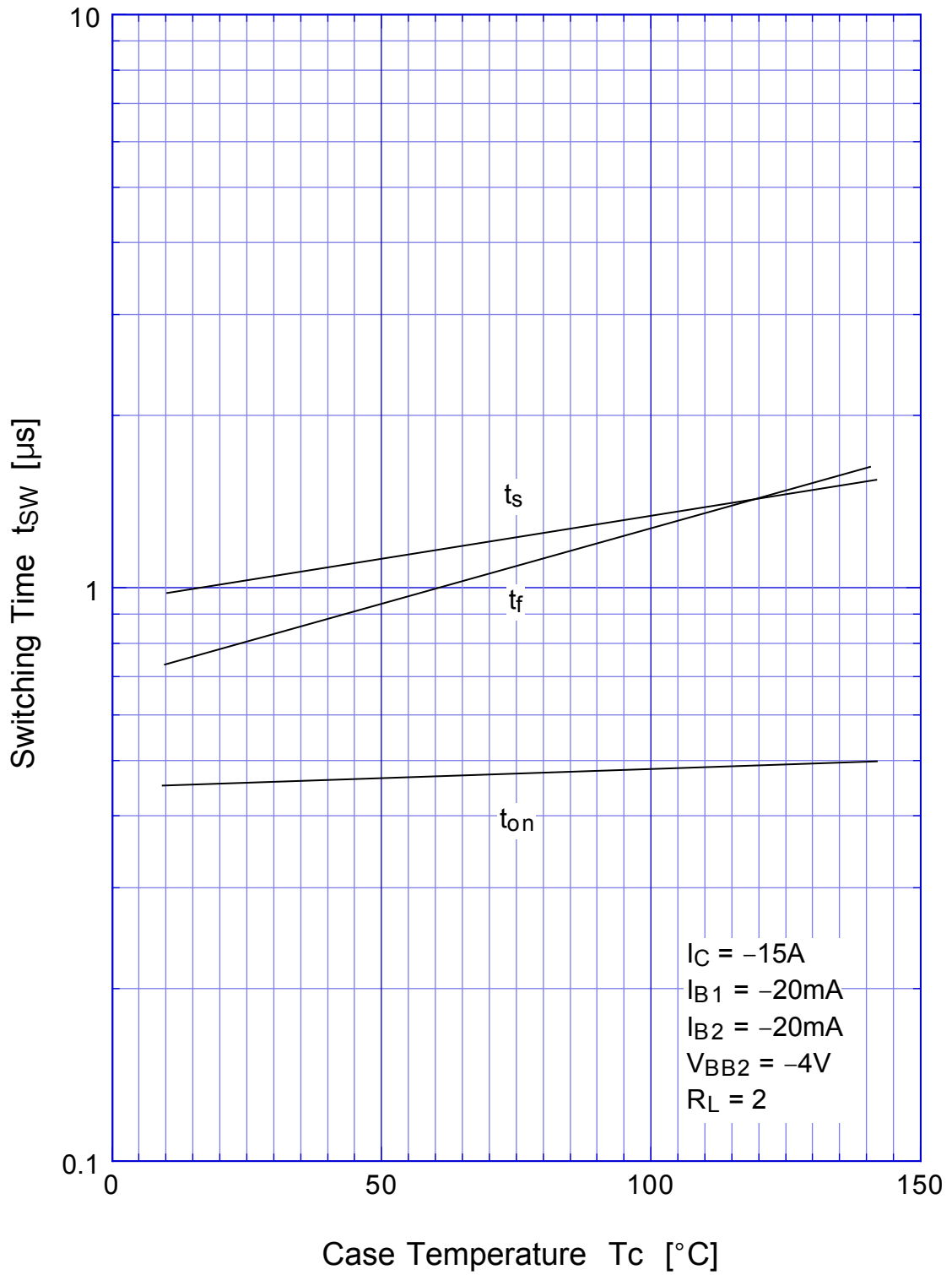

2SB1448 Transient Thermal Impedance

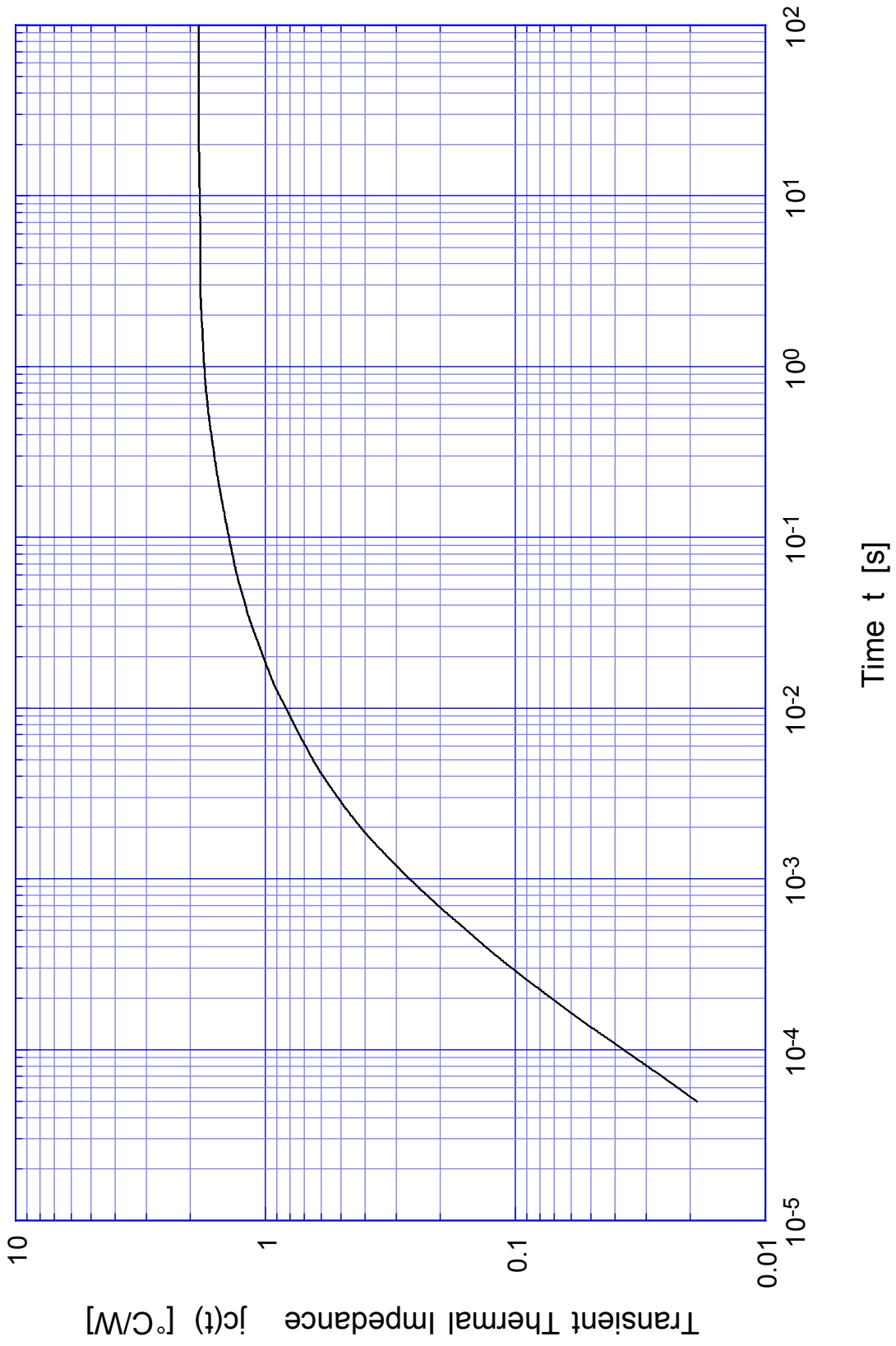

2SB1448

Forward Bias SOA

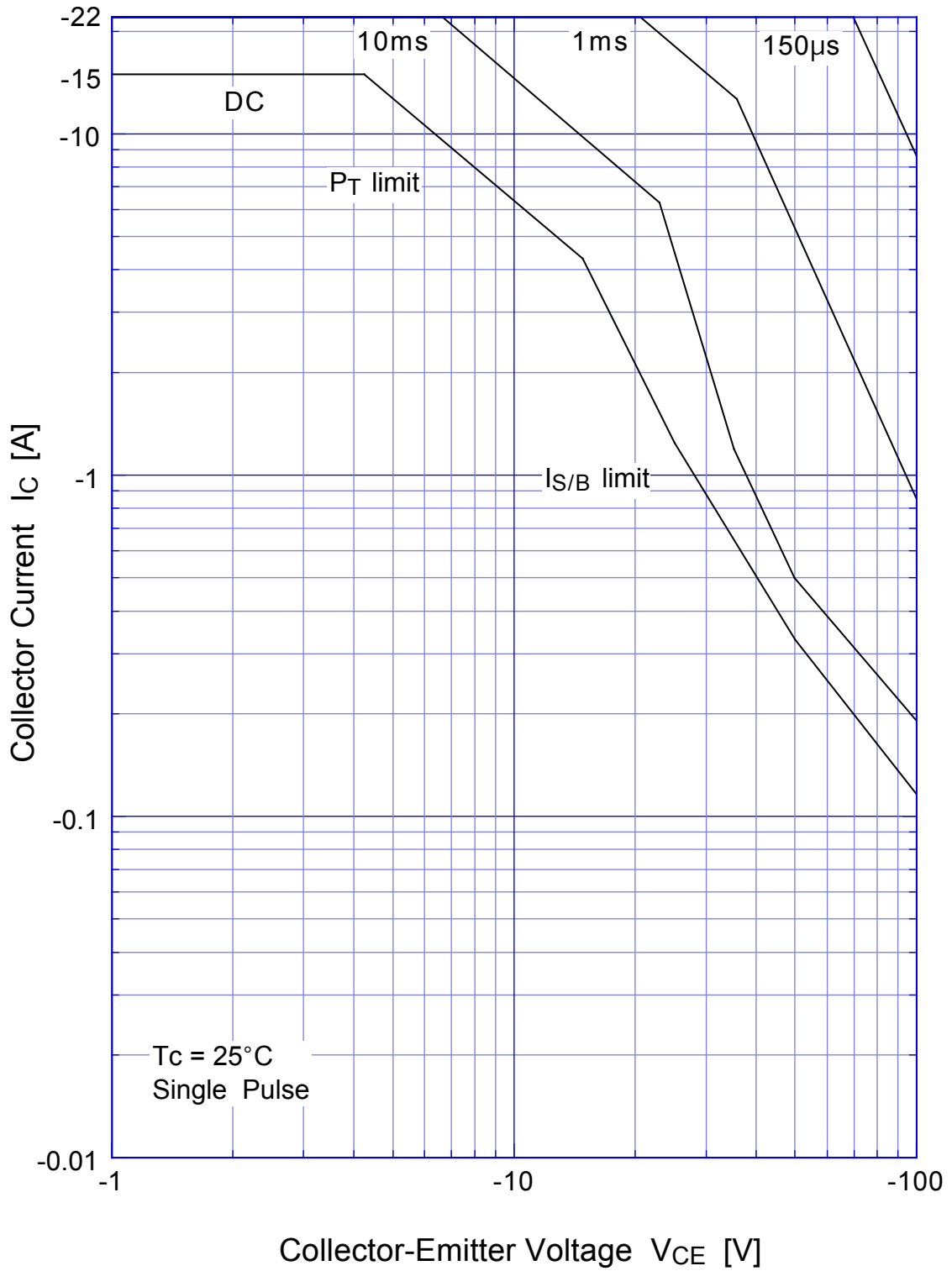

2SB1448 Collector Current Derating



2SB1448

Reverse Bias SOA

