

2SC4663
(TP5V20FS)

5A NPN

OUTLINE DIMENSIONS

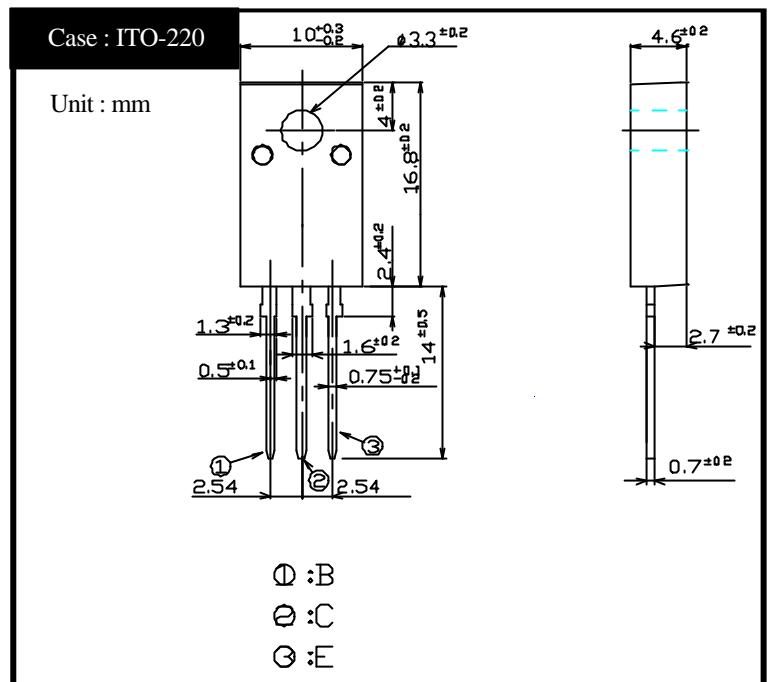

RATINGS

Absolute Maximum Ratings

Item	Symbol	Conditions	Ratings	Unit
Storage Temperature	T _{stg}		-55 ~ 150	
Junction Temperature	T _j		150	
Collector to Base Voltage	V _{CBO}		250	V
Collector to Emitter Voltage	V _{CEO}		200	V
Emitter to Base Voltage	V _{EBO}		7	V
Collector Current DC	I _C		5	A
Collector Current Peak	I _{CP}		10	
Base Current DC	I _B		2	A
Base Current Peak	I _{BP}		4	
Total Transistor Dissipation	P _T	T _c = 25	25	W
Dielectric Strength	V _{dis}	Terminals to case, AC 1 minute	2	kV
Mounting Torque	TOR	(Recommended torque : 0.3N·m)	0.5	N·m

Electrical Characteristics (T_c=25)

Item	Symbol	Conditions	Ratings	Unit
Collector to Emitter Sustaining Voltage	V _{CEO(sus)}	I _C = 0.1A	Min 200	V
Collector Cutoff Current	I _{CBO}	At rated Voltage	Max 0.1	mA
	I _{CEO}		Max 0.1	
Emitter Cutoff Current	I _{EBO}	At rated Voltage	Max 0.1	mA
DC Current Gain	h _{FE}	V _{CE} = 2V, I _C = 2.5A	10 ~ 25 ^{*1}	
	h _{FEL}	V _{CE} = 2V, I _C = 1mA	Min 10	
Collector to Emitter Saturation Voltage	V _{CE(sat)}	I _C = 2.5A	Max 1.0	V
Base to Emitter Saturation Voltage	V _{BE(sat)}	I _B = 0.5A	Max 1.5	V
Thermal Resistance	θ _{JC}	Junction to case	Max 5.0	/W
Transition Frequency	f _T	V _{CE} = 10V, I _C = 0.5A	TYP 13	MHz
Turn on Time	t _{on}	I _C = 2.5A	Max 0.3	μs
Storage Time	t _s	I _{B1} = 0.5A, I _{B2} = 1A	Max 1.0	
Fall Time	t _f	R _L = 60 Ω, V _{BB2} = 4V	Max 0.1	

2SC4663

$h_{FE} - I_C$

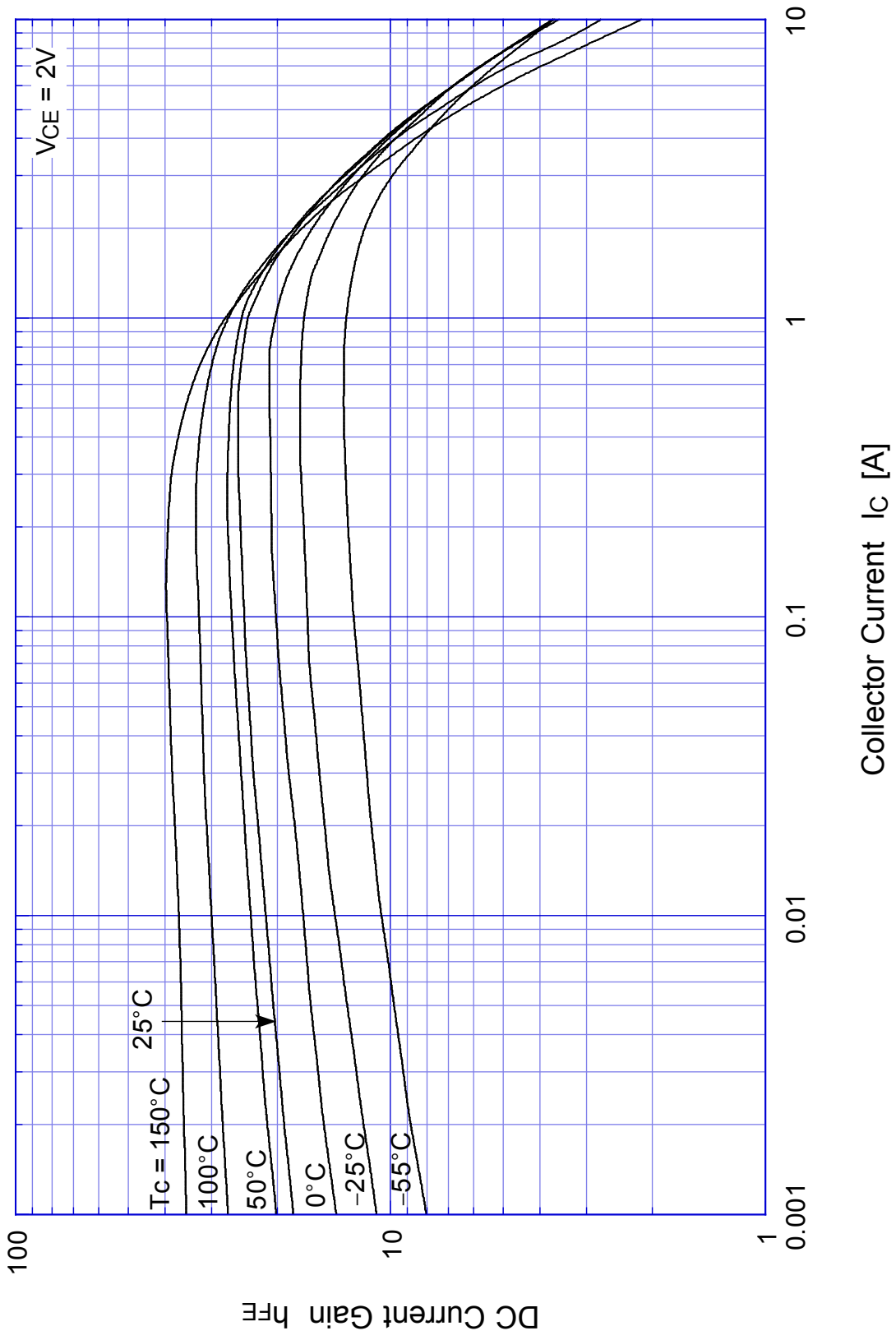

2SC4663 Saturation Voltage

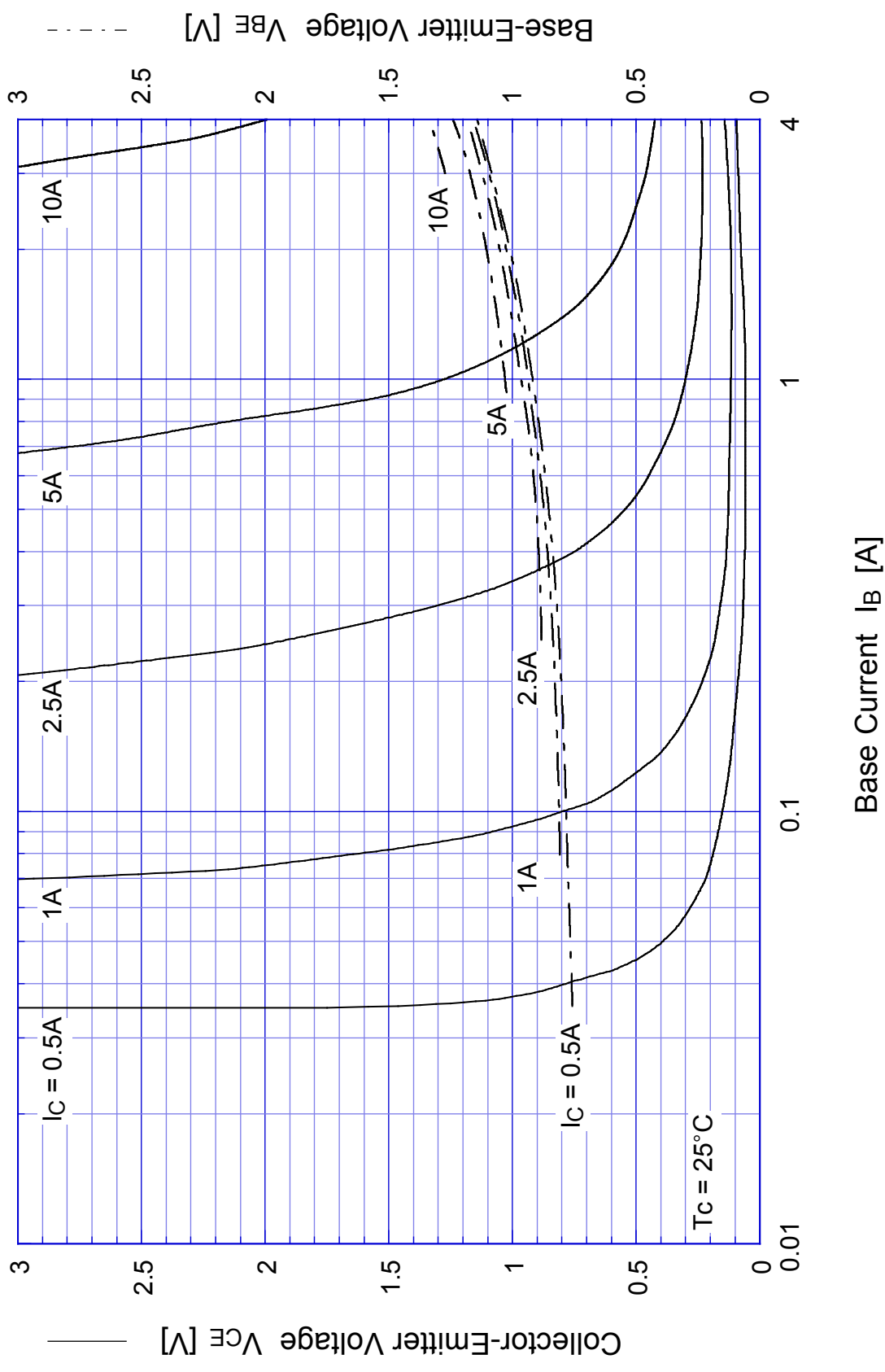

2SC4663

Switching Time - I_C

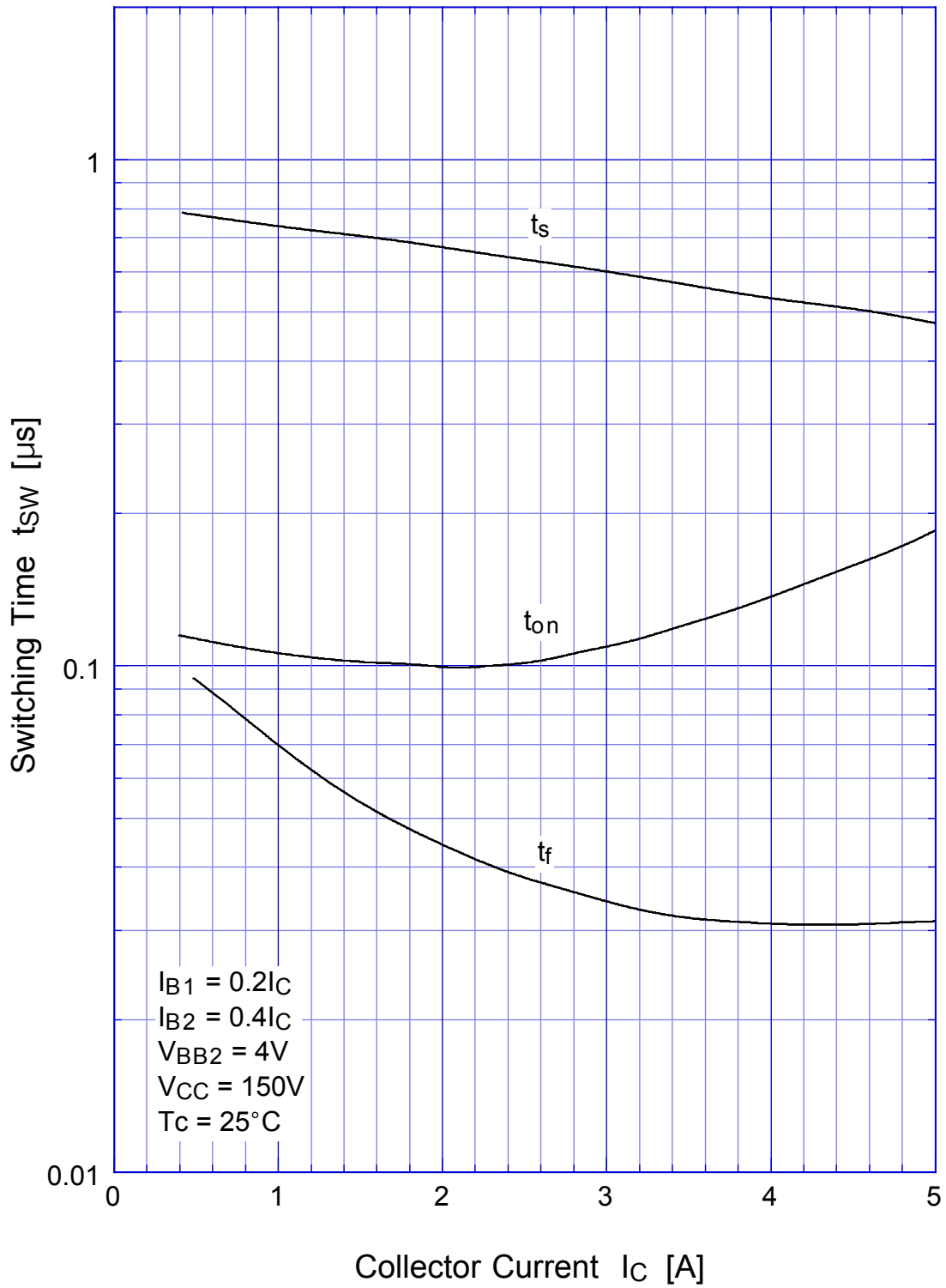

2SC4663

Switching Time - Tc

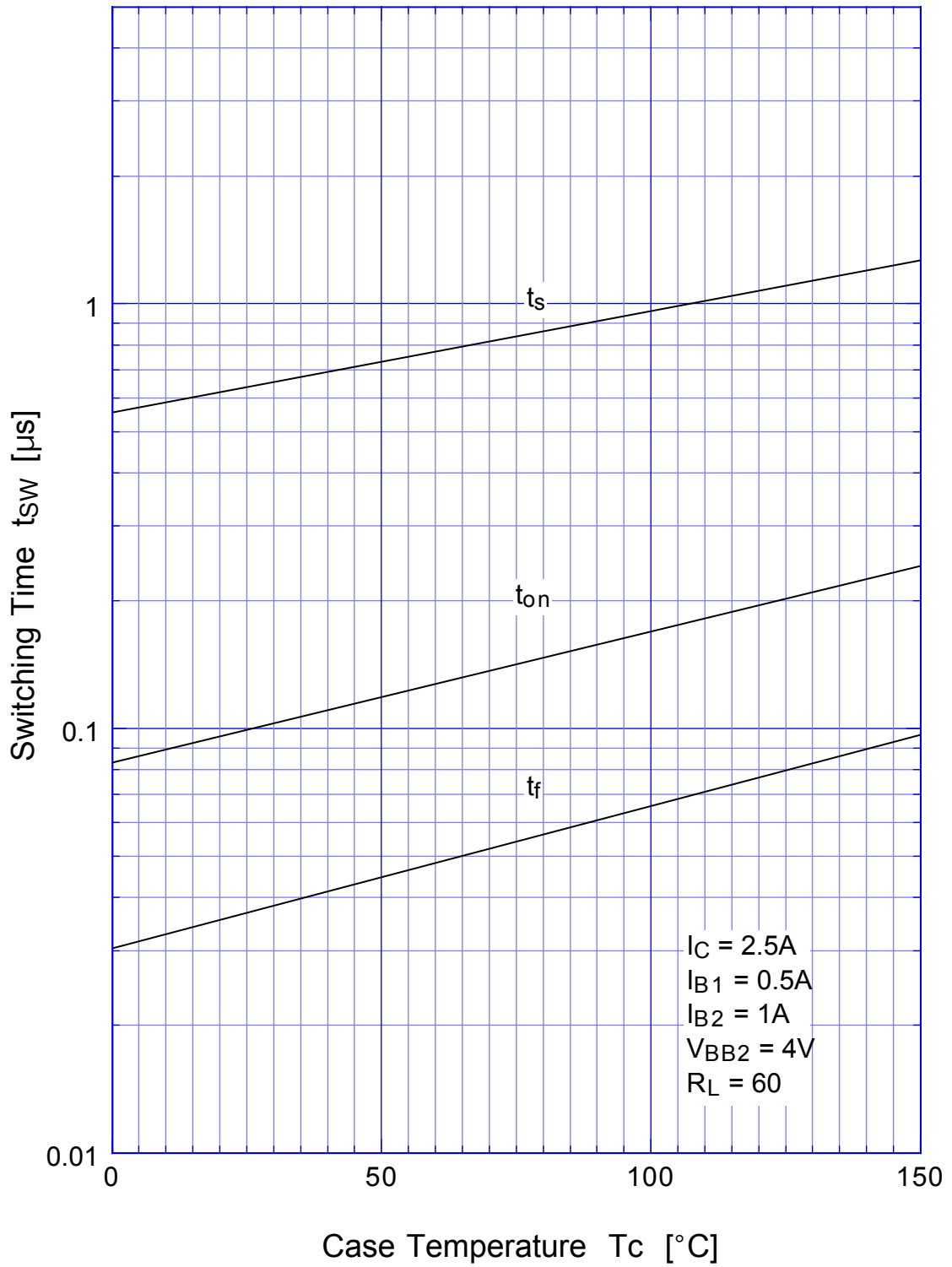

2SC4663

Forward Bias SOA

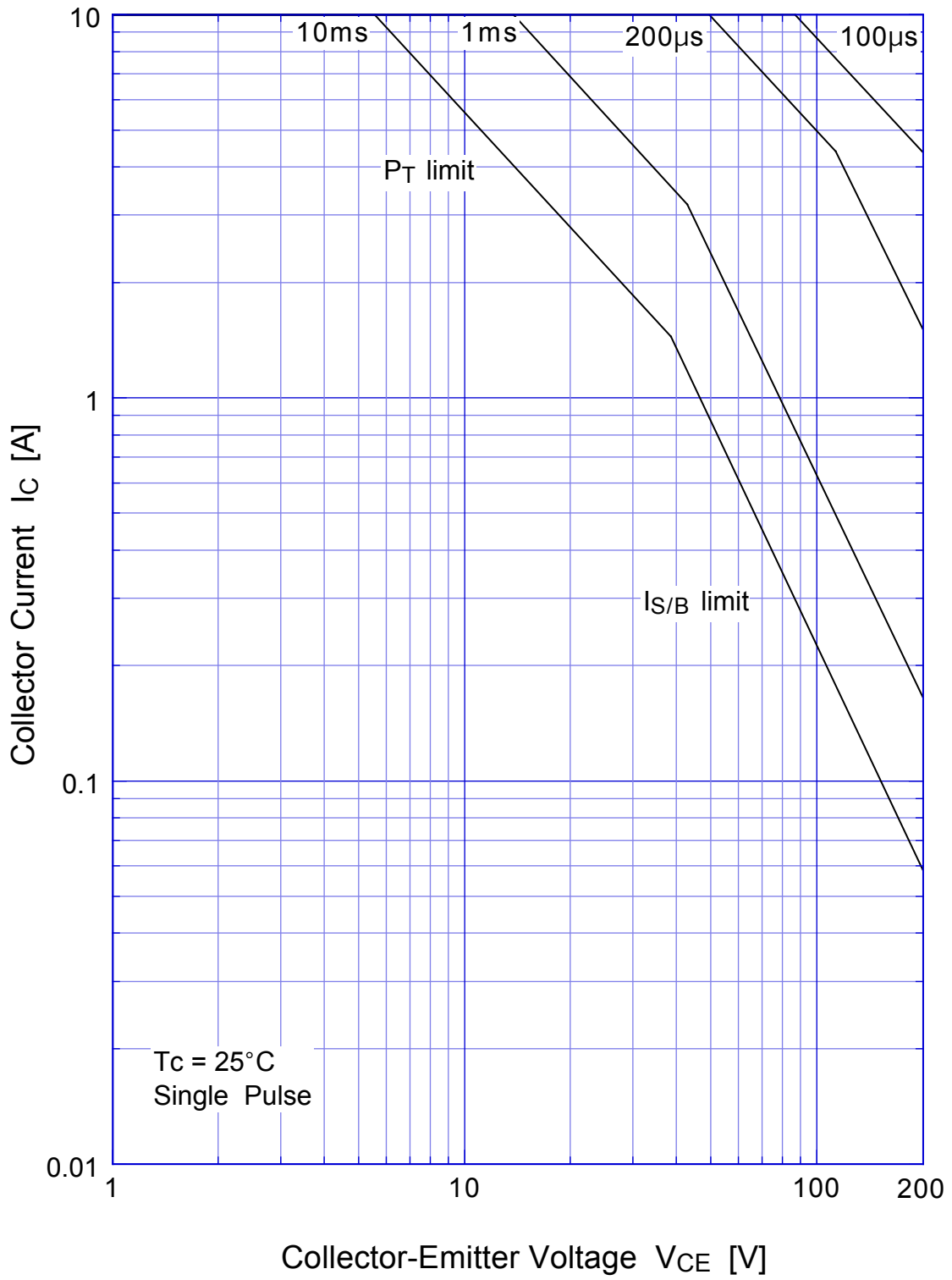

2SC4663 Collector Current Derating

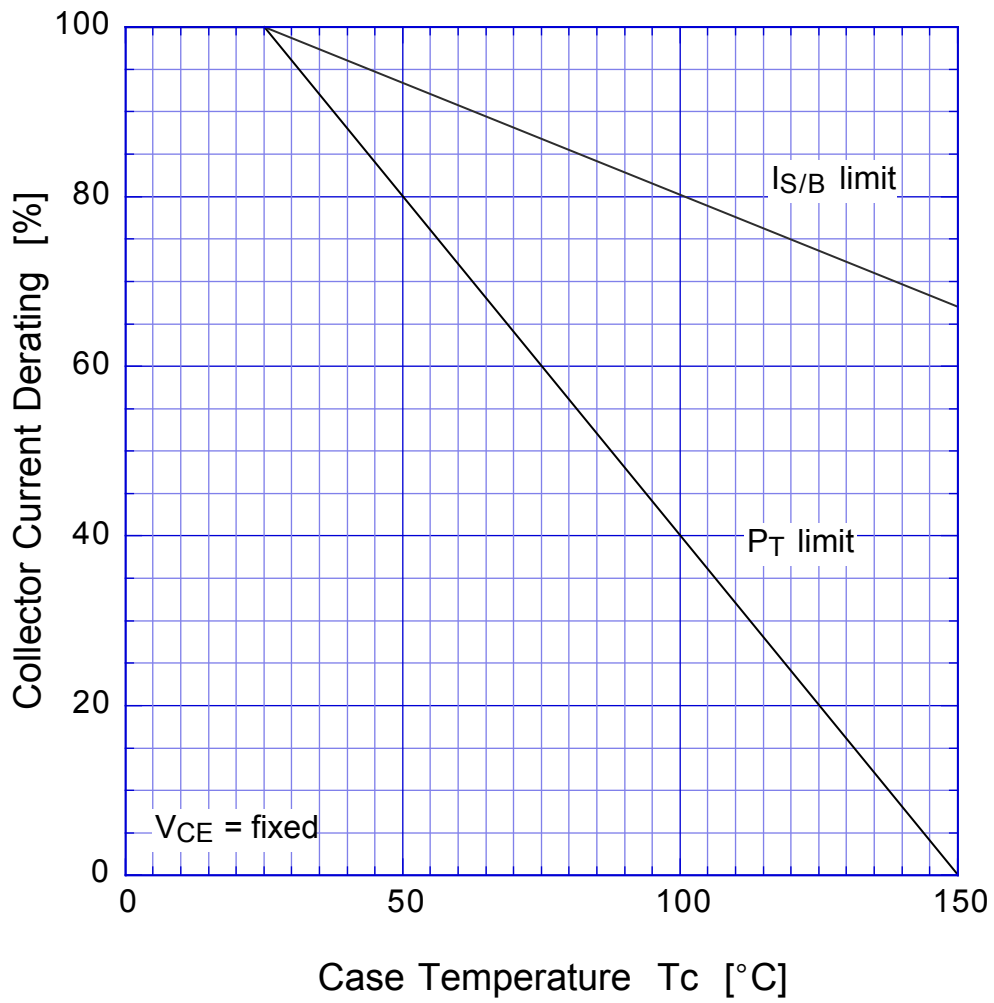

2SC4663

Reverse Bias SOA

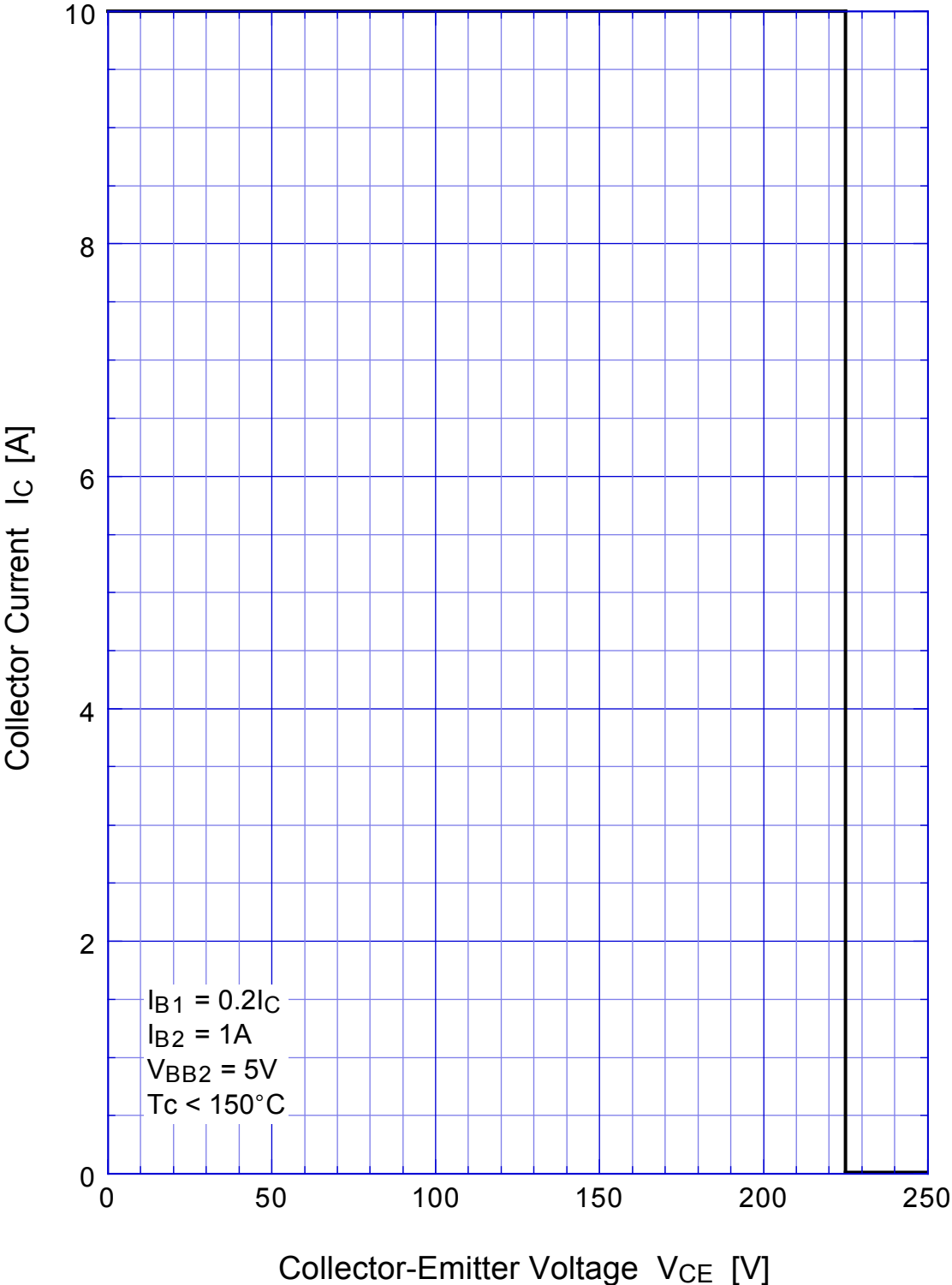

2SC4663 Transient Thermal Impedance

