

SHINDENGEN

VX-2 Series Power MOSFET

N-Channel Enhancement type

2SK2193
(FP12W50VX2)

500V 12A

FEATURES

- Input capacitance (Ciss) is small.
Especially, input capacitance at 0 bias is small.
- The static Rds(on) is small.
- The switching time is fast.

APPLICATION

- Switching power supply of AC 100V input
- High voltage power supply
- Inverter

RATINGS

● Absolute Maximum Ratings (Tc = 25°C)

Item	Symbol	Conditions	Ratings	Unit
Storage Temperature	T _{stg}		-55~150	°C
Channel Temperature	T _{ch}		150	
Drain-Source Voltage	V _{DSS}		500	V
Gate-Source Voltage	V _{GS}		±30	
Continuous Drain Current (DC)	I _D		12	A
Continuous Drain Current (Peak)	I _{DP}		36	
Continuous Source Current (DC)	I _S		12	
Total Power Dissipation	P _T		50	W
Single Pulse Avalanche Current	I _{AS}	T _{ch} = 25°C	12	A
Dielectric Strength	V _{dis}	Terminals to case, AC 1 minute	2	kV
Mounting Torque	TOR	(Recommended torque : 0.5N·m)	0.8	N·m

OUTLINE DIMENSIONS

Case : ITO-3P

(Unit : mm)

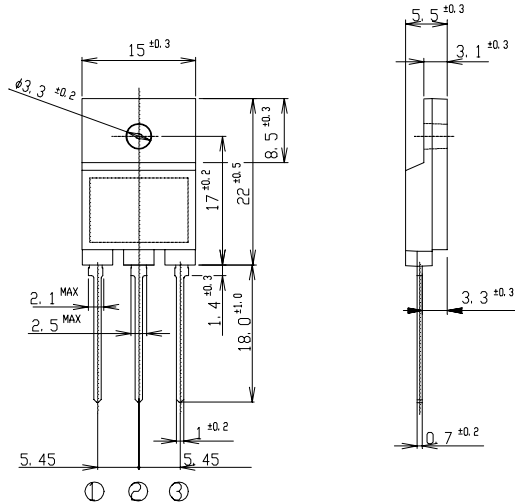

⊙ : G
⊘ : D
⊚ : S

●Electrical Characteristics $T_c = 25^\circ\text{C}$

Item	Symbol	Conditions	Min.	Typ.	Max.	Unit
Drain-Source Breakdown Voltage	$V_{(BR)DSS}$	$I_D = 1\text{mA}, V_{GS} = 0\text{V}$	500			V
Zero Gate Voltage Drain Current	I_{DSS}	$V_{DS} = 500\text{V}, V_{GS} = 0\text{V}$			250	μA
Gate-Source Leakage Current	I_{GSS}	$V_{GS} = \pm 30\text{V}, V_{DS} = 0\text{V}$			± 0.1	
Forward Transconductance	g_{fs}	$I_D = 6\text{A}, V_{DS} = 10\text{V}$	3.0	7.6		S
Static Drain-Source On-state Resistance	$R_{DS(ON)}$	$I_D = 6\text{A}, V_{GS} = 10\text{V}$		0.55	0.7	Ω
Gate Threshold Voltage	V_{TH}	$I_D = 1\text{mA}, V_{DS} = 10\text{V}$	2.5	3.0	3.5	V
Source-Drain Diode Forwade Voltage	V_{SD}	$I_S = 6\text{A}, V_{GS} = 0\text{V}$			1.5	
Thermal Resistance	θ_{jc}	junction to case			2.5	$^\circ\text{C}/\text{W}$
Total Gate Charge	Q_g	$V_{DD} = 400\text{V}, V_{GS} = 10\text{V}, I_D = 12\text{A}$		42		nC
Input Capacitance	C_{iss}	$V_{DS} = 10\text{V}, V_{GS} = 0\text{V}, f = 1\text{MHz}$		1200		pF
Reverse Transfer Capacitance	C_{rss}			90		
Output Capacitance	C_{oss}			270		
Turn-On Time	t_{on}	$I_D = 6\text{A}, V_{GS} = 10\text{V}, R_L = 25\Omega$		90	130	ns
Turn-Off Time	t_{off}			190	280	

2SK2193

Transfer Characteristics

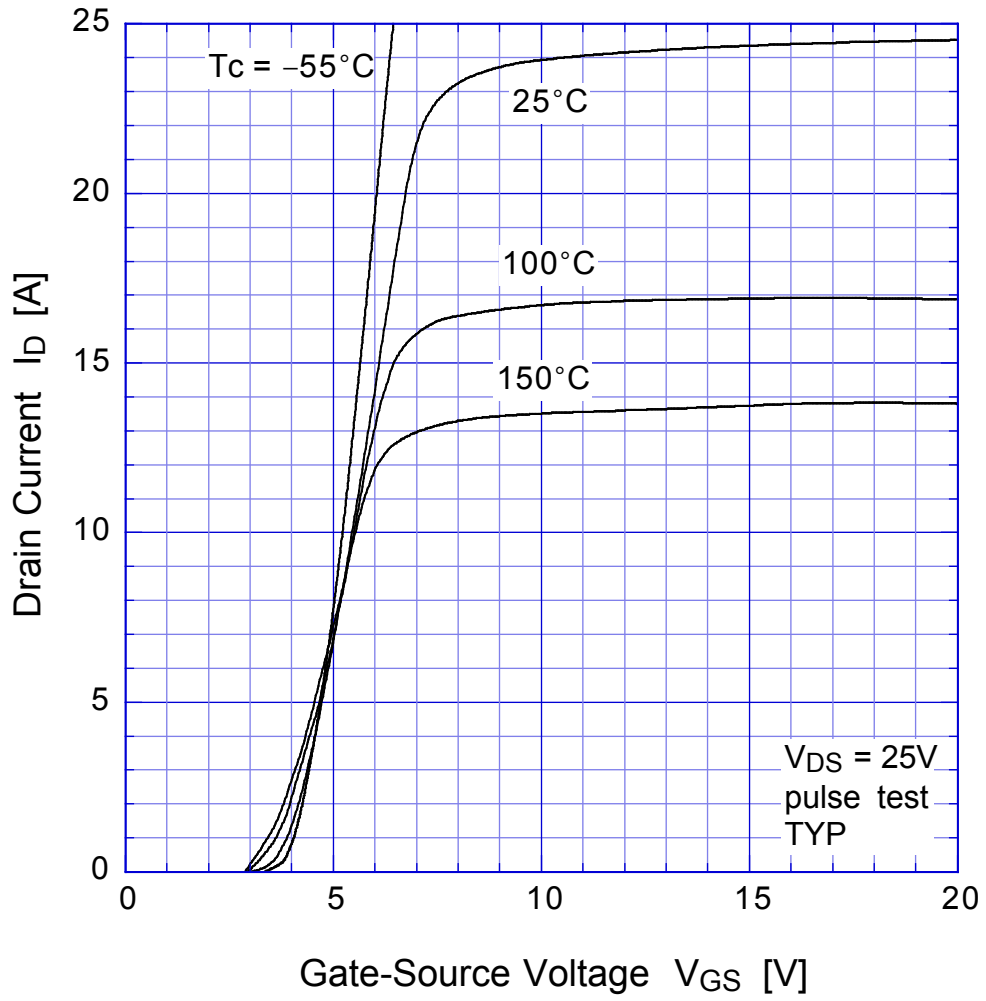

2SK2193 Static Drain-Source On-state Resistance

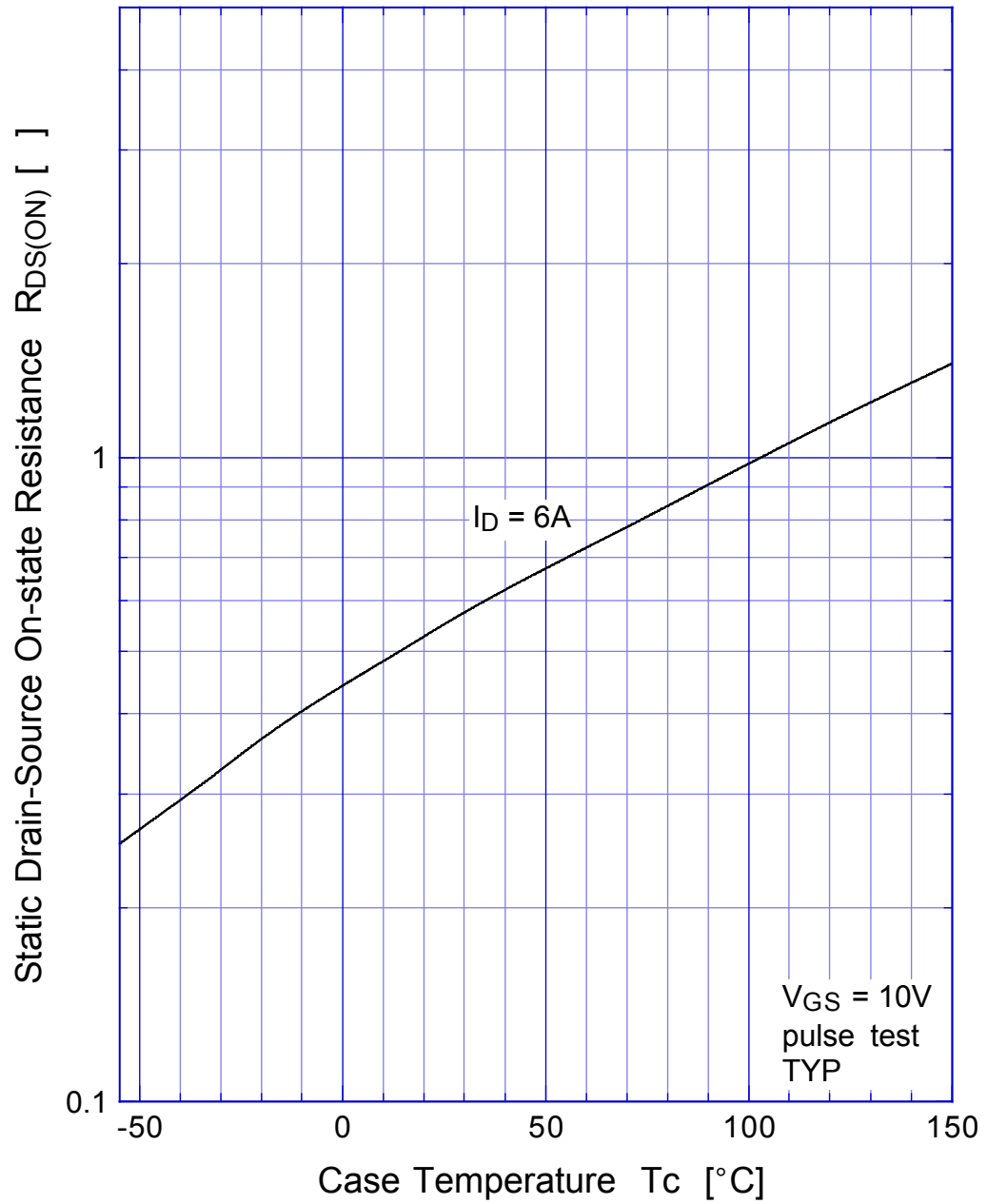

2SK2193 Gate Threshold Voltage

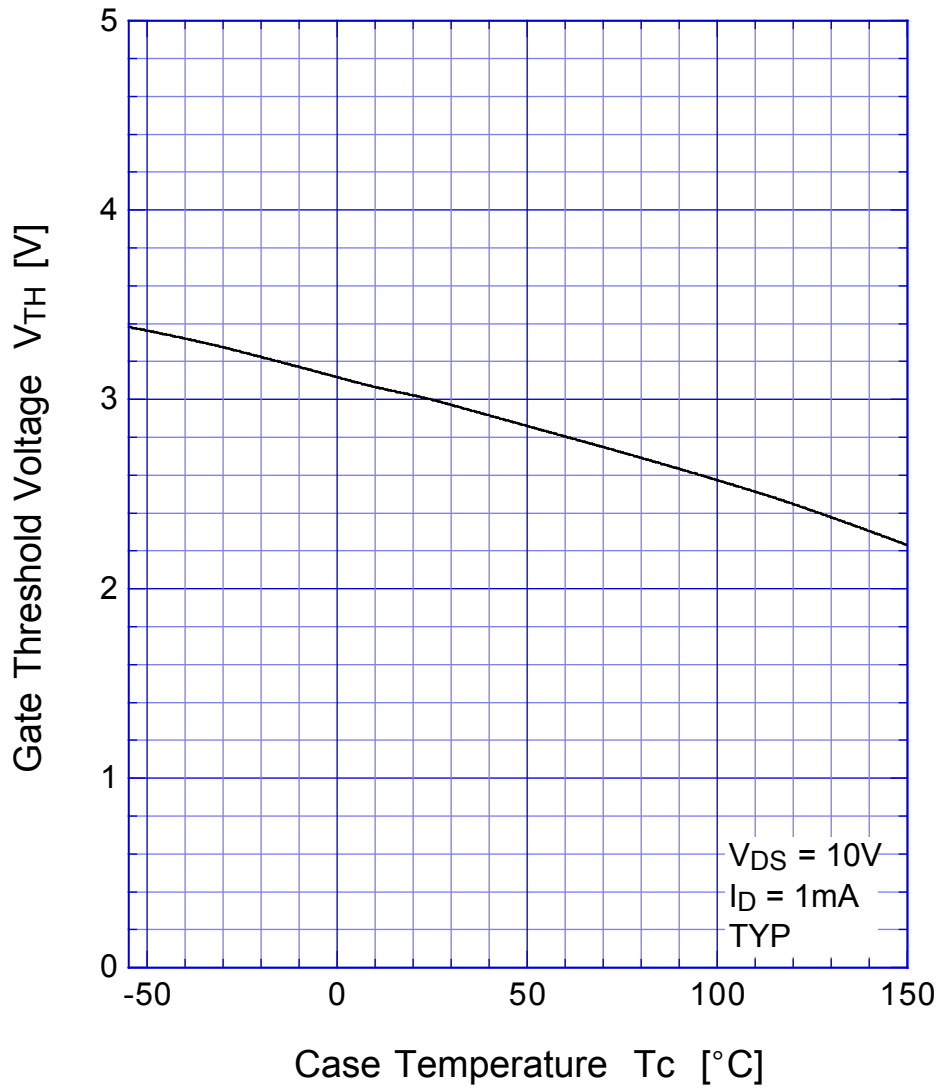

2SK2193 Safe Operating Area

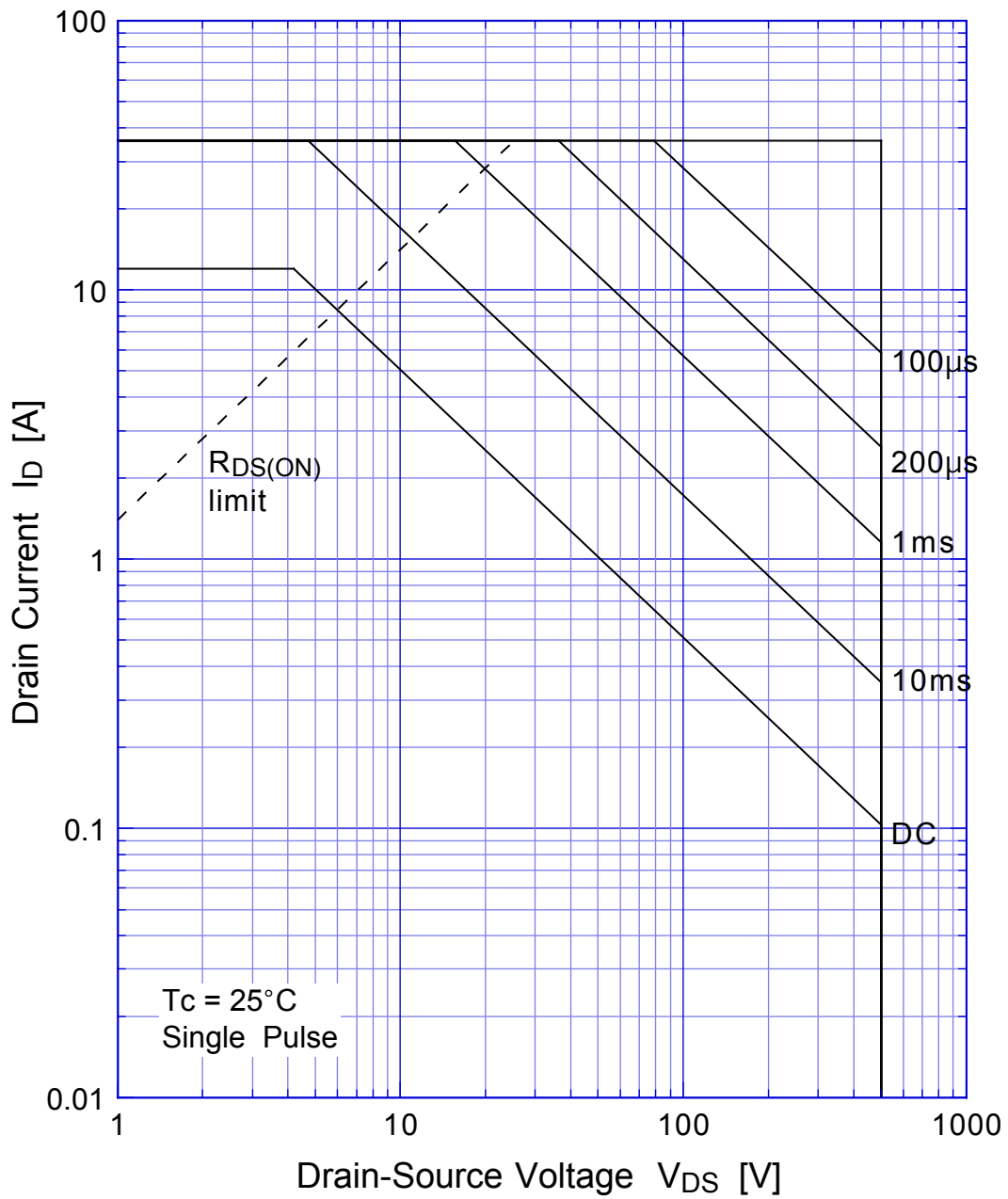

2SK2193 Transient Thermal Impedance

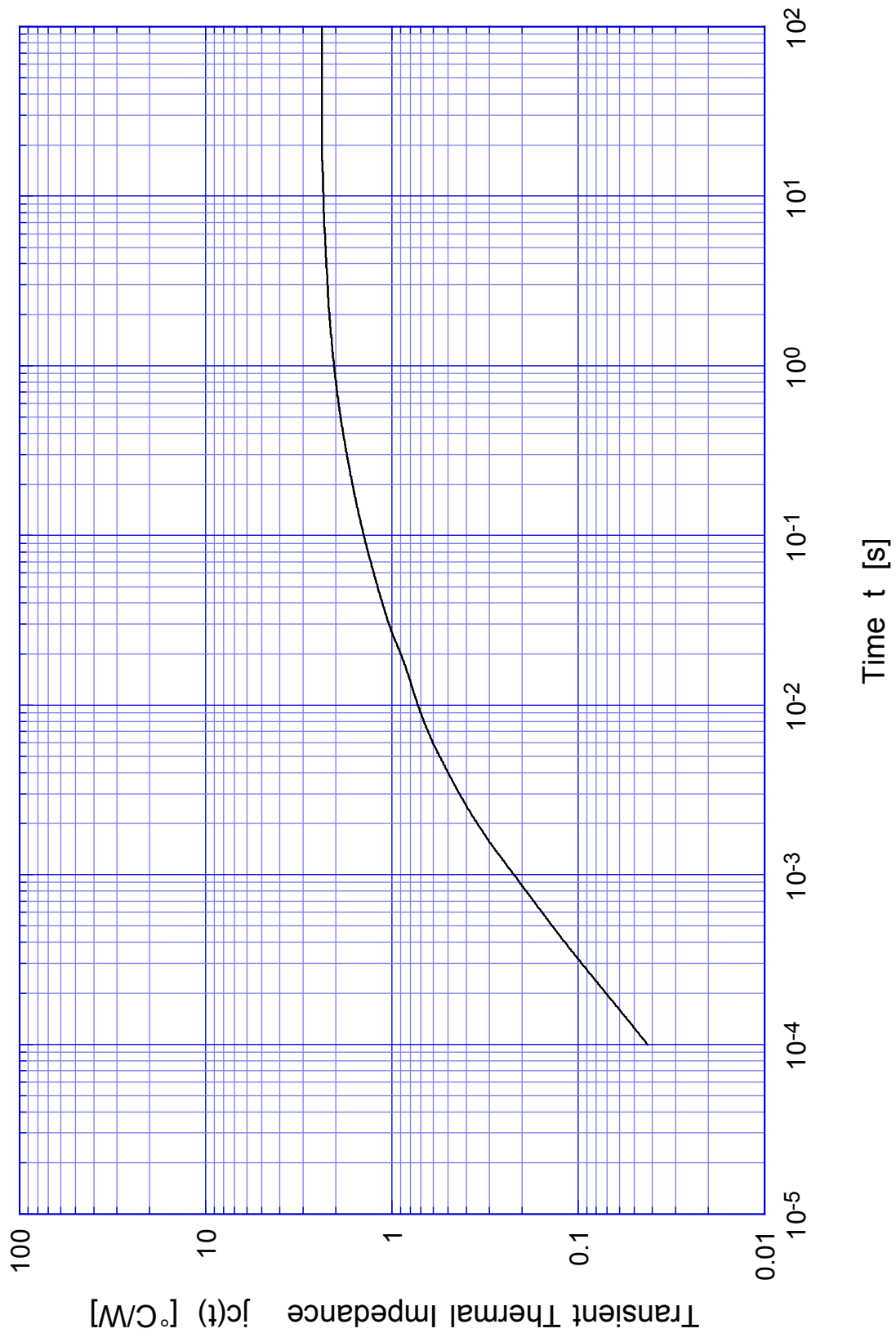

2SK2193

Capacitance

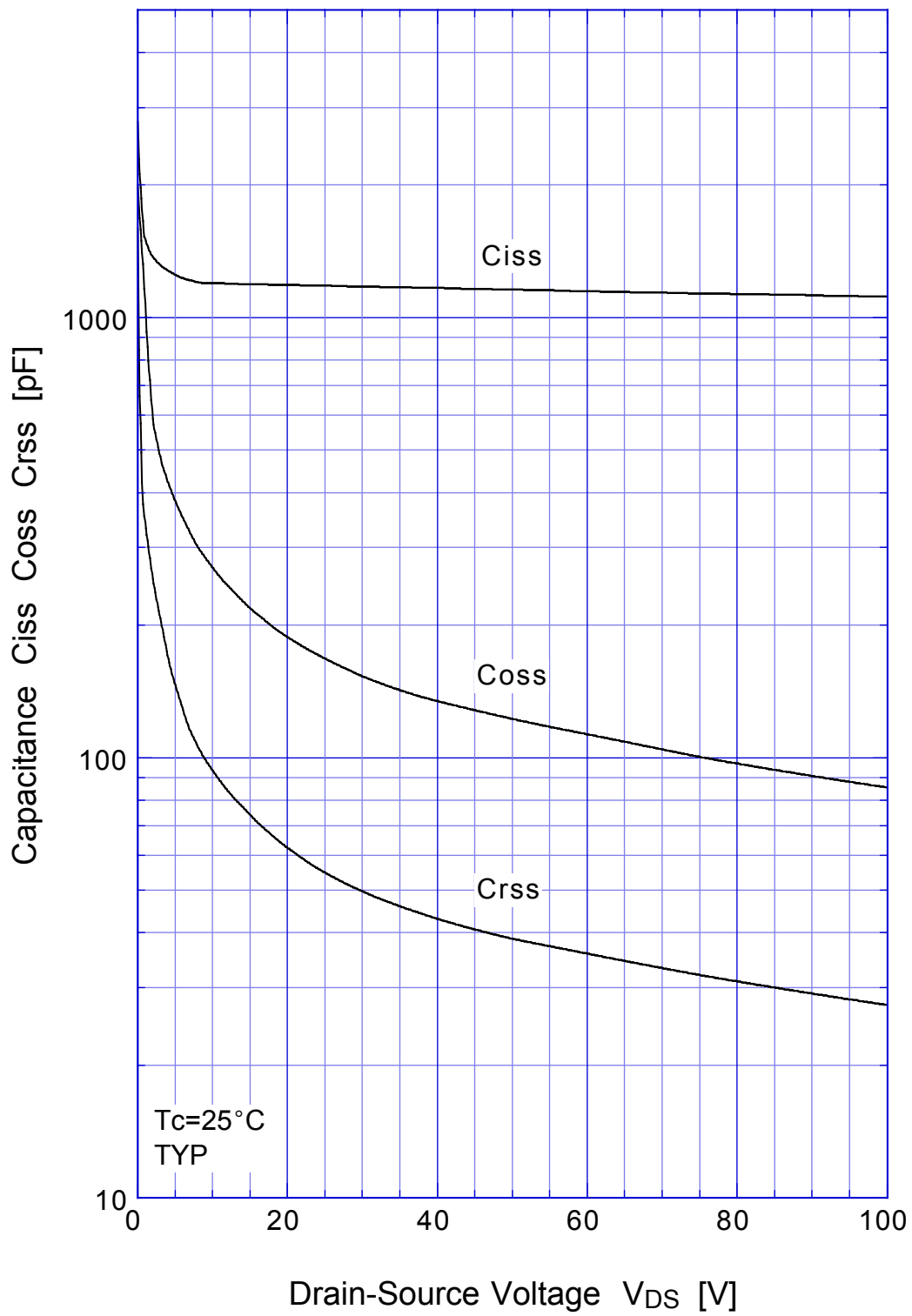

2SK2193

Power Derating



2SK2193 Gate Charge Characteristics

