

# SHINDENGEN

## VX-2 Series Power MOSFET

N-Channel Enhancement type

**2SK3013**  
**(FP16W60VX2)**

**600V 16A**

### FEATURES

- Input capacitance (Ciss) is small. Especially, input capacitance at 0 bias is small.
- The static Rds(on) is small.
- The switching time is fast.
- Avalanche resistance guaranteed.

### APPLICATION

- Switching power supply of AC 100-200V input
- Inverter
- Power Factor Control Circuit

### OUTLINE DIMENSIONS

Case : ITO-3P

(Unit : mm)

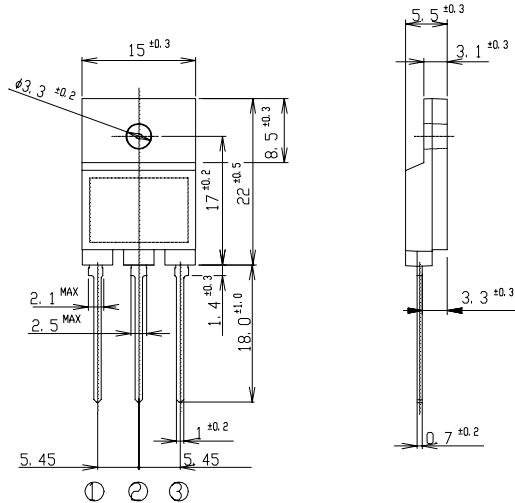

① : G  
② : D  
③ : S

### RATINGS

- Absolute Maximum Ratings (Tc = 25°C)

Item	Symbol	Conditions	Ratings	Unit
Storage Temperature	T <sub>stg</sub>		-55~150	°C
Channel Temperature	T <sub>ch</sub>		150	
Drain-Source Voltage	V <sub>DSS</sub>		600	V
Gate-Source Voltage	V <sub>GSS</sub>		±30	
Continuous Drain Current (DC)	I <sub>D</sub>		16	A
Continuous Drain Current (Peak)	I <sub>DP</sub>		48	
Continuous Source Current (DC)	I <sub>S</sub>		16	
Total Power Dissipation	P <sub>T</sub>		70	W
Single Pulse Avalanche Current	I <sub>AS</sub>	T <sub>ch</sub> = 25°C	16	A
Dielectric Strength	V <sub>dis</sub>	Terminals to case, AC 1 minute	2	kV
Mounting Torque	TOR	(Recommended torque : 0.5N·m)	0.8	N·m

●Electrical Characteristics  $T_c = 25^\circ\text{C}$

Item	Symbol	Conditions	Min.	Typ.	Max.	Unit
Drain-Source Breakdown Voltage	$V_{(BR)DSS}$	$I_D = 1\text{mA}, V_{GS} = 0\text{V}$	600			V
Zero Gate Voltage Drain Current	$I_{DSS}$	$V_{DS} = 600\text{V}, V_{GS} = 0\text{V}$			250	$\mu\text{A}$
Gate-Source Leakage Current	$I_{GSS}$	$V_{GS} = \pm 30\text{V}, V_{DS} = 0\text{V}$			$\pm 0.1$	
Forward Transconductance	$g_{fs}$	$I_D = 8\text{A}, V_{DS} = 10\text{V}$	6.2	10.0		S
Static Drain-Source On-state Resistance	$R_{DS(ON)}$	$I_D = 8\text{A}, V_{GS} = 10\text{V}$		0.45	0.6	$\Omega$
Gate Threshold Voltage	$V_{TH}$	$I_D = 1\text{mA}, V_{DS} = 10\text{V}$	2.5	3	3.5	V
Source-Drain Diode Forward Voltage	$V_{SD}$	$I_S = 8\text{A}, V_{GS} = 0\text{V}$			1.5	
Thermal Resistance	$\theta_{jc}$	junction to case			1.78	$^\circ\text{C}/\text{W}$
Total Gate Charge	$Q_g$	$V_{GS} = 10\text{V}, I_D = 16\text{A}, V_{DD} = 400\text{V}$		85		nC
Input Capacitance	$C_{iss}$	$V_{DS} = 10\text{V}, V_{GS} = 0\text{V}, f = 1\text{MHz}$		2300		pF
Reverse Transfer Capacitance	$C_{rss}$			180		
Output Capacitance	$C_{oss}$			480		
Turn-On Time	$t_{on}$	$I_D = 8\text{A}, V_{GS} = 10\text{V}, R_L = 19\Omega$		130	280	ns
Turn-Off Time	$t_{off}$			260	500	

# 2SK3013

## Transfer Characteristics

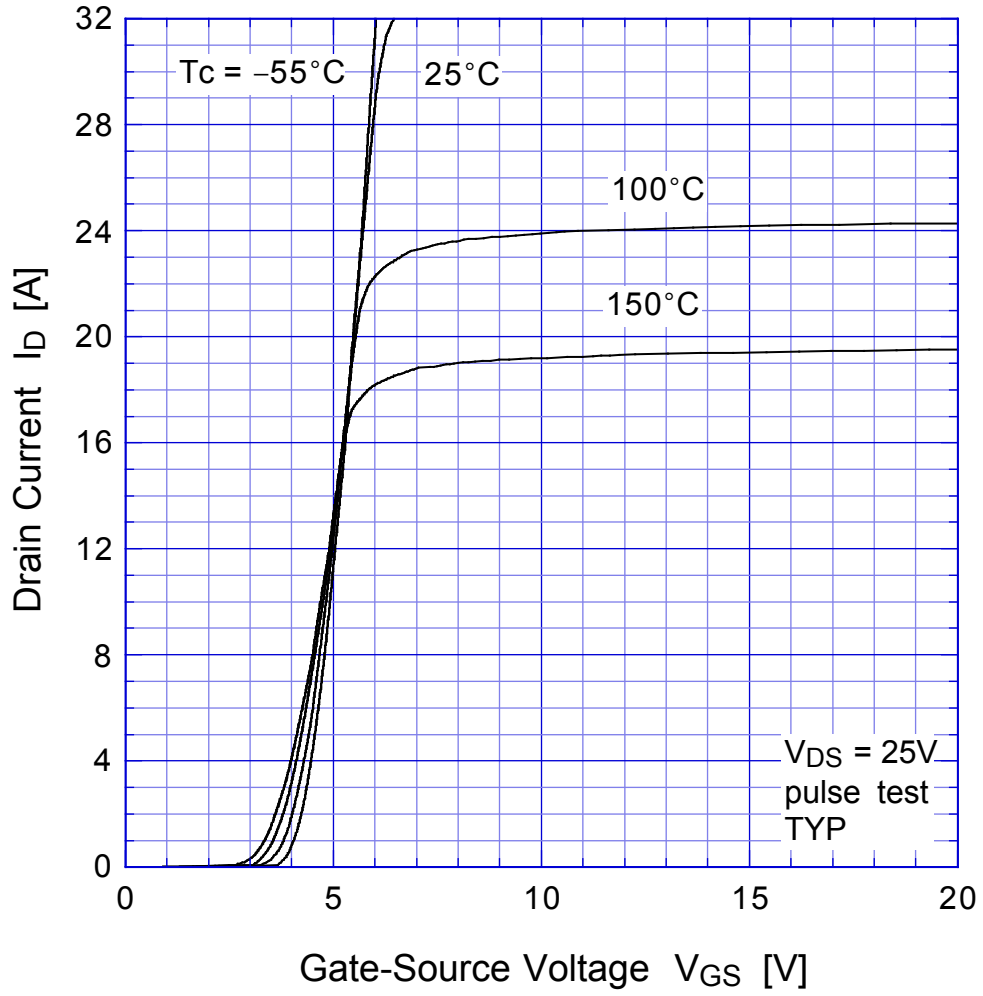

## 2SK3013 Static Drain-Source On-state Resistance

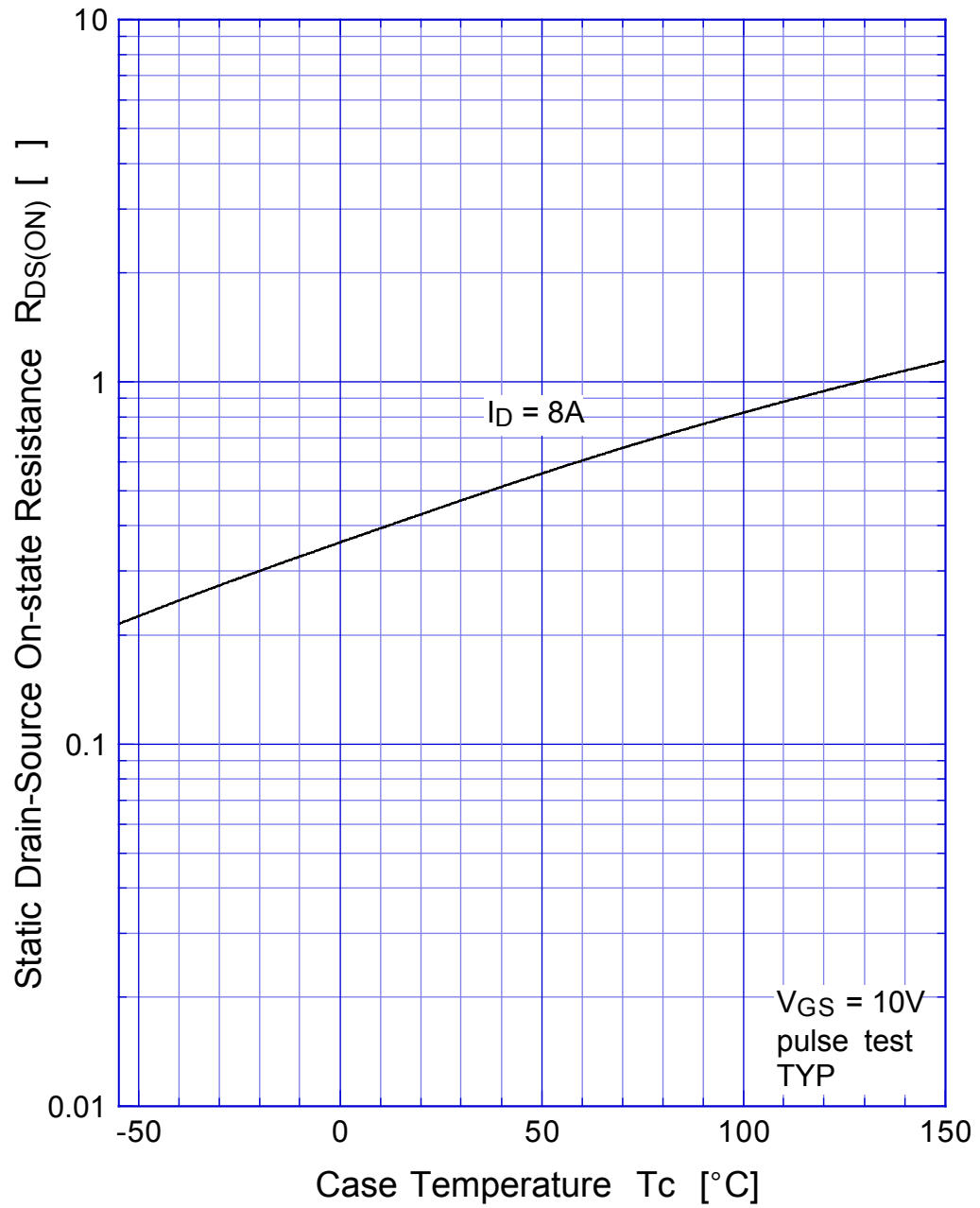

## 2SK3013 Gate Threshold Voltage

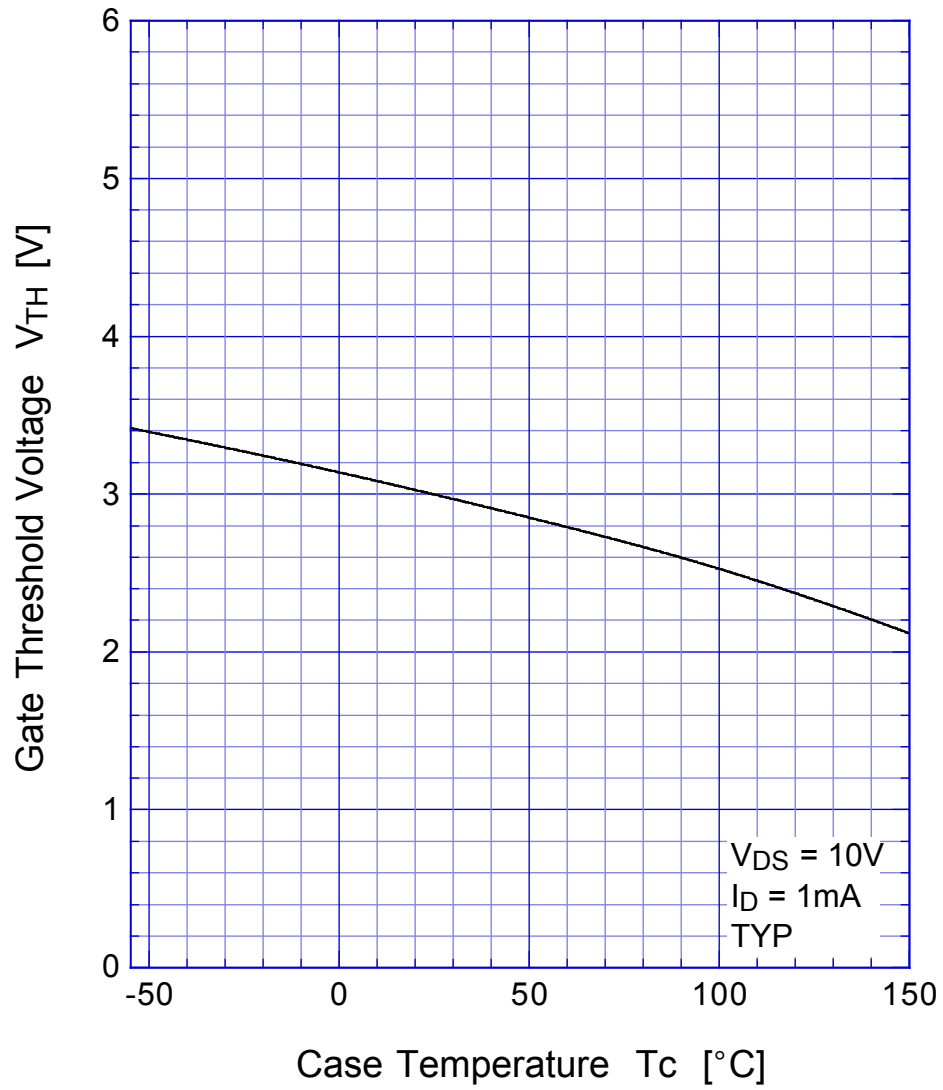

# 2SK3013 Safe Operating Area

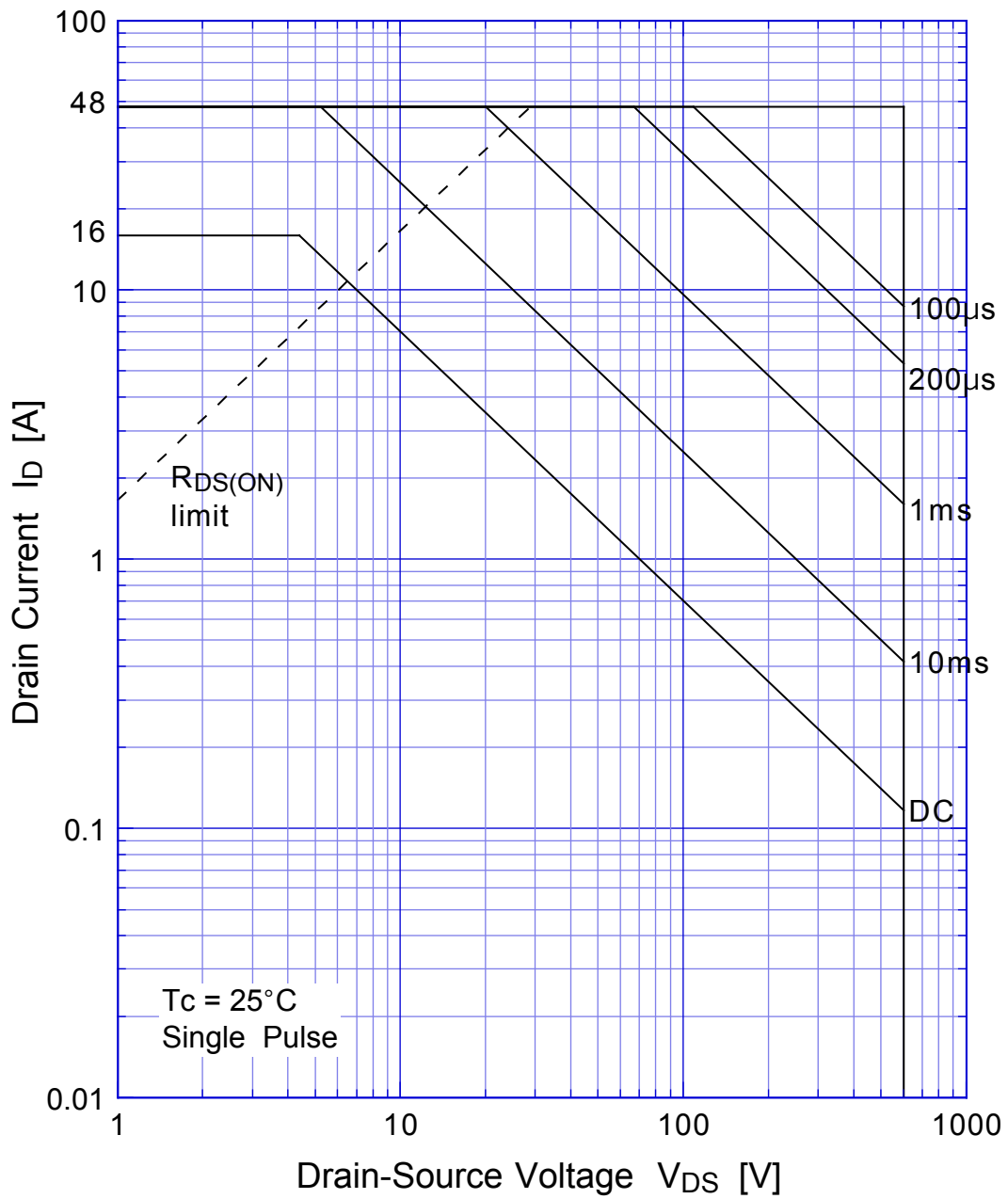

# 2SK3013 Transient Thermal Impedance

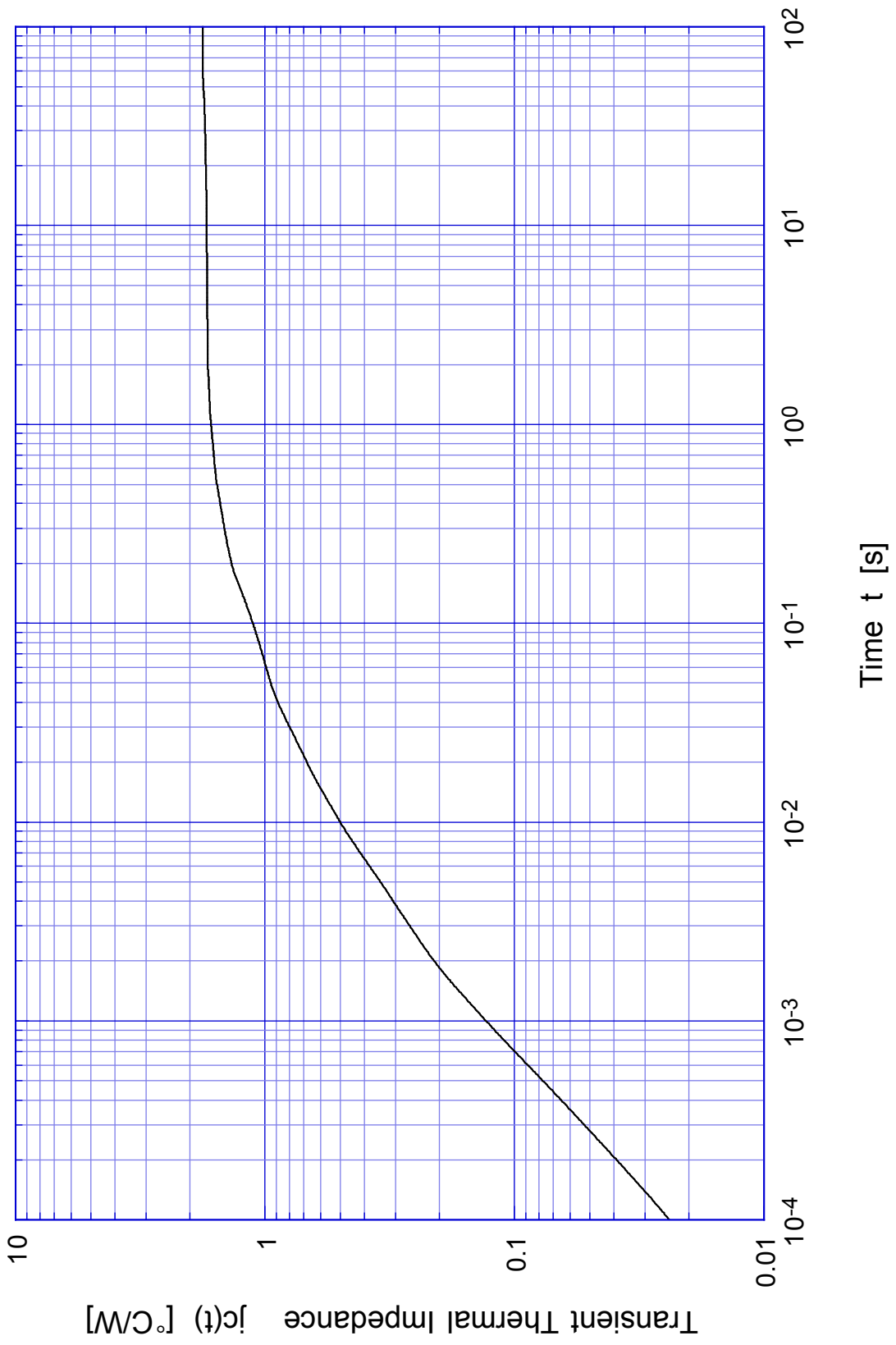

### 2SK3013 Single Avalanche Energy Derating





# 2SK3013 Capacitance

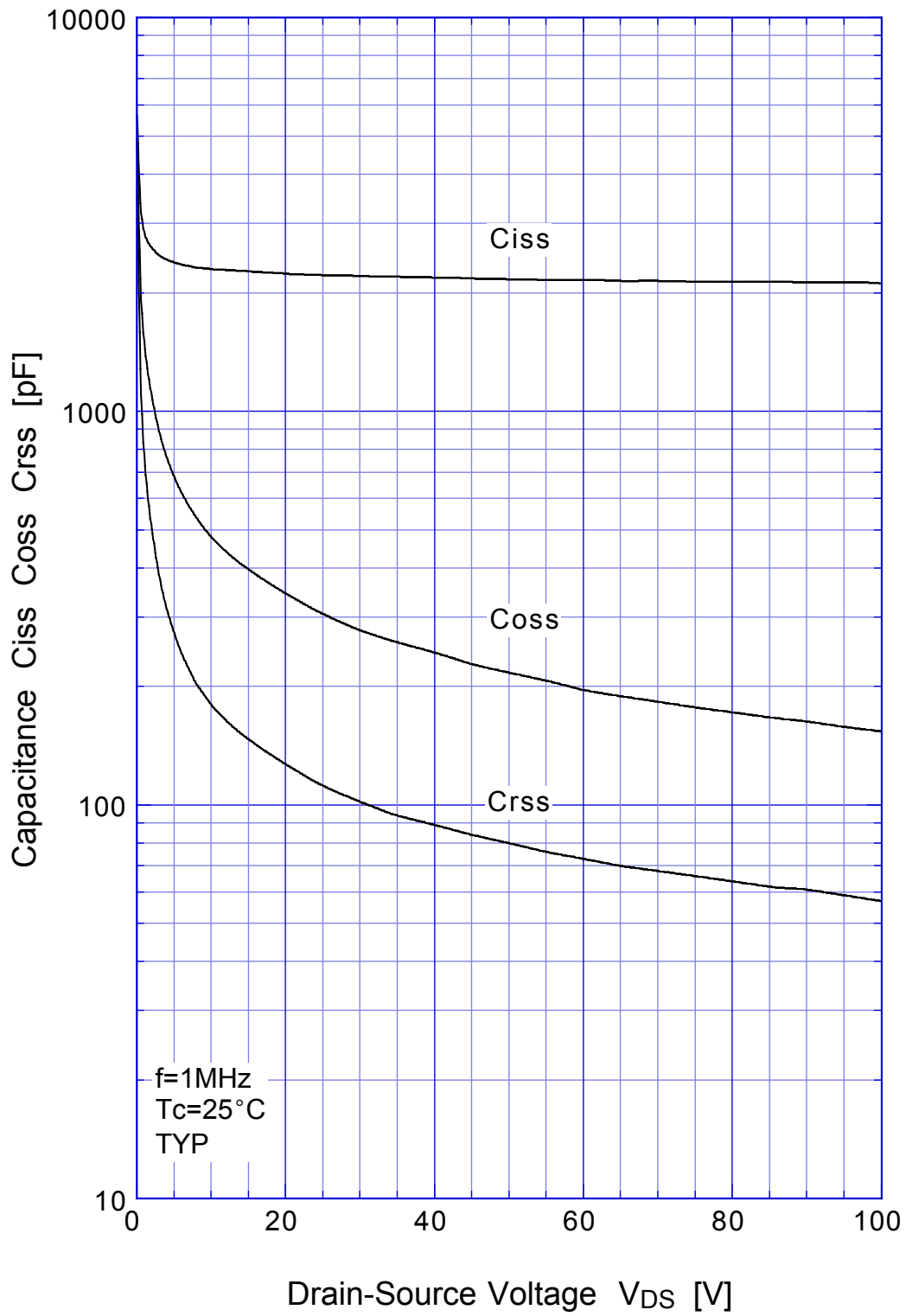

# 2SK3013 Single Avalanche Current - Inductive Load

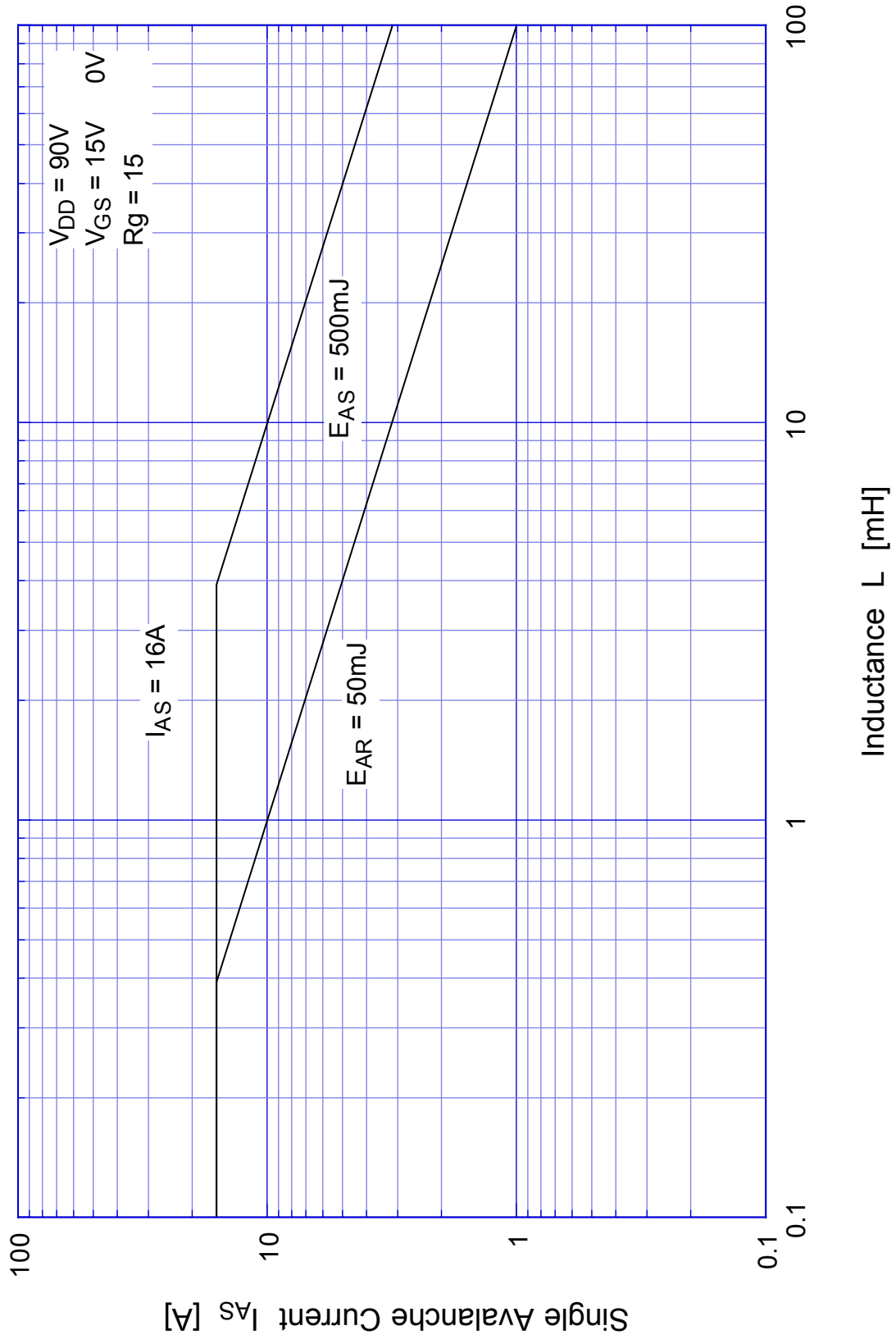

2SK3013

Power Derating



## 2SK3013 Gate Charge Characteristics

