

MA4510

OUTLINE DIMENSIONS

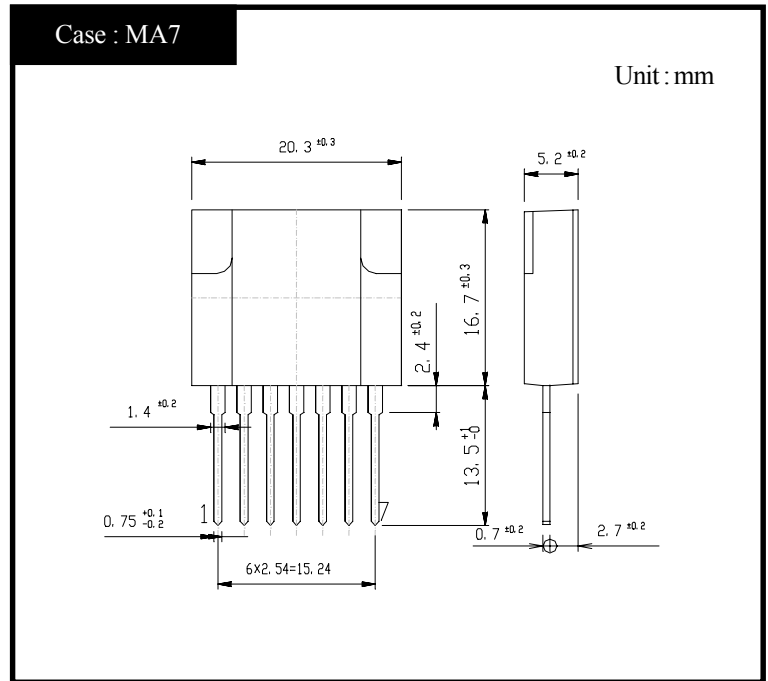

RATINGS

●Absolute Maximum Ratings

Item	Symbol	Conditions	Ratings	Unit
Storage Temperature	T _{stg}		-30~125	°C
Operating Temperature	T _{op}		-20~125	°C
Junction Temperature	T _j		150	°C
Peak Input Voltage	V _{in}	②+,③-,⑤-	500	V
Input Current	I _{in}	DC ②+,③-	3	A
		Pulse ②+,③- Duty 1/2	5	A
Maximum Power Dissipation	P _D	T _a =25°C	3	W
		Heatsink T _c =100°C	13	W
Dielectric Strength	V _{dis}	Terminals To Case AC 1 min	2	kV
Insulation Resistance		Terminals To Case 500VDC	100	MΩ
Max Voltage ④ to ⑥	V(④)•⑥	④+,⑥-	6	V
Max Current ⑥ to ④	I(⑥)•④	⑥+,④- (Peak) Duty Max 1/2	200	mA
Reverse Current	I _Z	⑤+,④-	MAX 20	mA

●Electrical Characteristics (T_c=25°C)

Item	Symbol	Conditions	Ratings	Unit
Q1	Zero Gate Voltage Drea in Current	I _{DSS} V _{DS} =500V, V _{GS} =0V,②+,③-	MAX 250	μA
	Static Drain-Source On-State Resistance	R _{DS(on)} I _D =1.5A, ②+,③- V _{GS} =10V,⑤+,③-	TYP (2.0)	Ω
			MAX (2.3)	Ω
	Thermal Resistance	θ _{jc} Junction to Case	MAX 3.8	°C/W
D1	Reverse Current	I _R V _R =500V, ①+,②-	MAX 10	μA
	Forward Voltage	V _F I _F =0.6A, ②+,①-	MAX 1.7	V
Q2	Fold Back Detection Voltage	③+,④-	TYP 0.7	V

●Standard Operating Condition•Design Standard For Application Circuit

Item	Conditions	Ratings	Unit
Input Rated Voltage		AC90~132	V
Output Nominal Voltage		12	V
Output Nominal Current		2.5	A

●Standard Operating Condition•Standard Operating Characteristics (Ta=25°C)

Item	Conditions	Ratings	Unit		
Minimum Input Full Load Output Voltage	V _{in} =90V, I _O =2.5A	12.0±0.6	V	Fig 1, ① Refer	
Maximum Input Light Load Output Voltage	V _{in} =132V, I _O =0.25A	12.0±0.6	V	Fig 1, ② Refer	
Over Current Protection	Foldback Current	V _{in} =132V, V _O =10V	MAX 3.8	A	Fig 1, ③ Refer
	Short Circuit	V _{in} =132V, R _O =0.5 Ω	Nodamage To Any Device, Automatic Recovery.	-	Fig 1, ④ Refer

Figure in ○=Terminal Sign

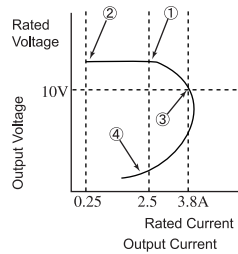
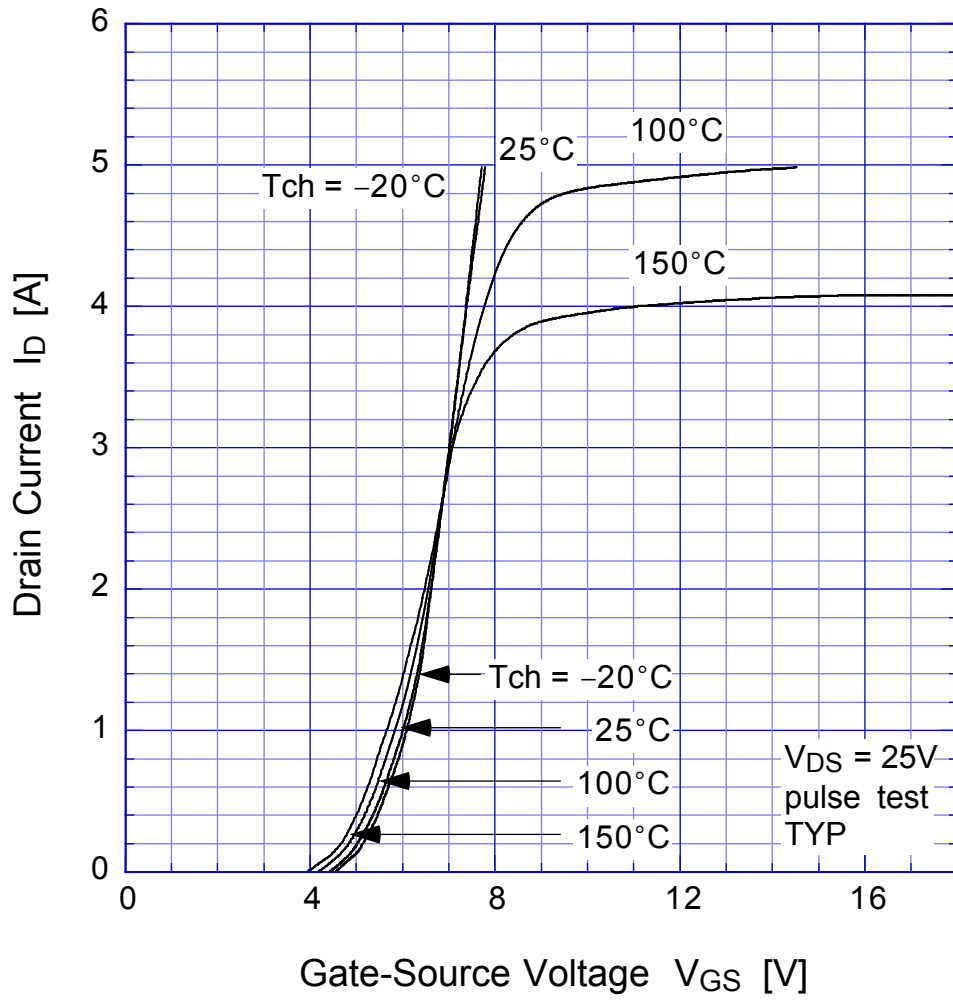

Fig1. Output Voltage/Current

MA4510

Transfer Characteristics



MA4510 Static Drain-Source On-state Resistance

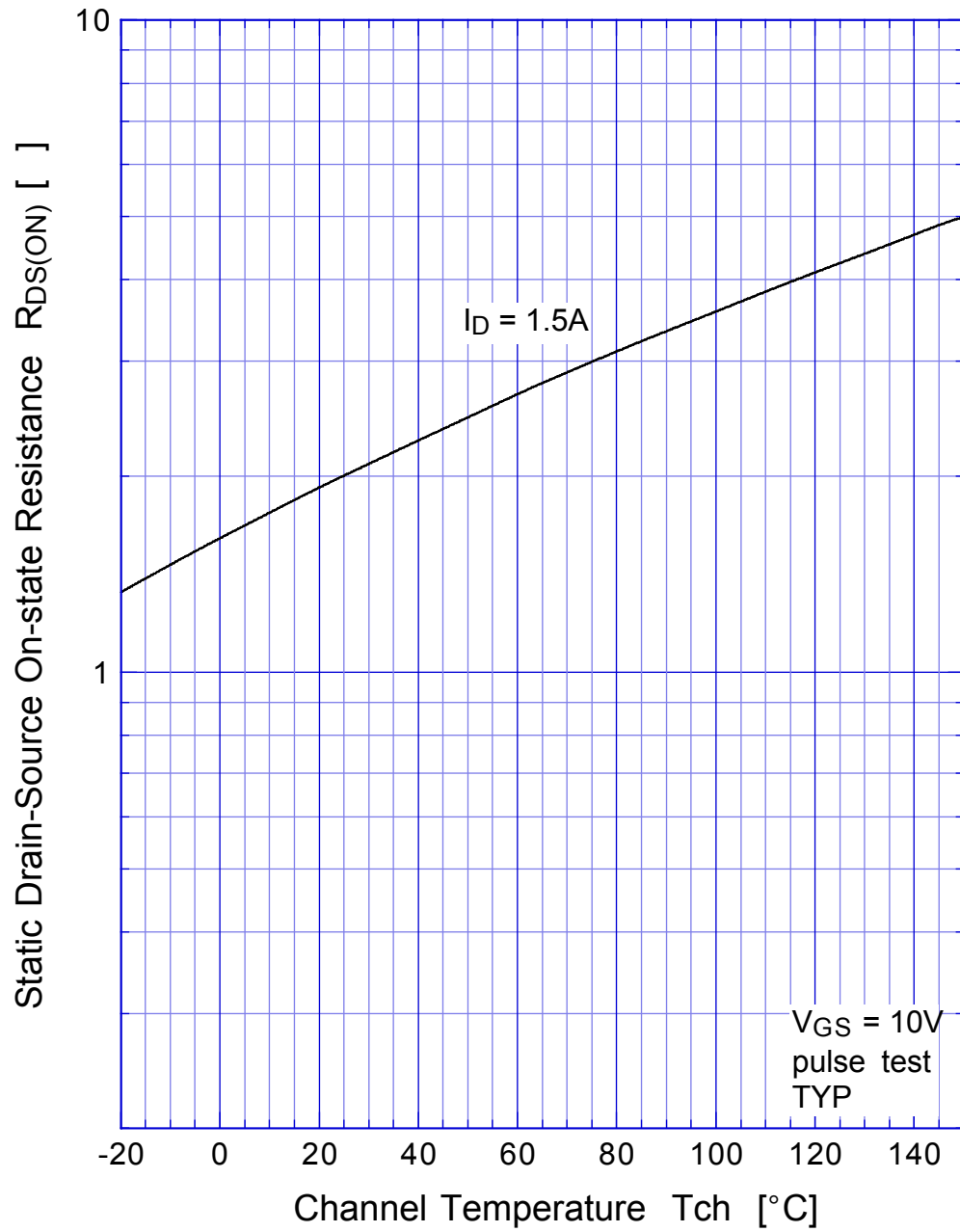

MA4510 Gate Threshold Voltage

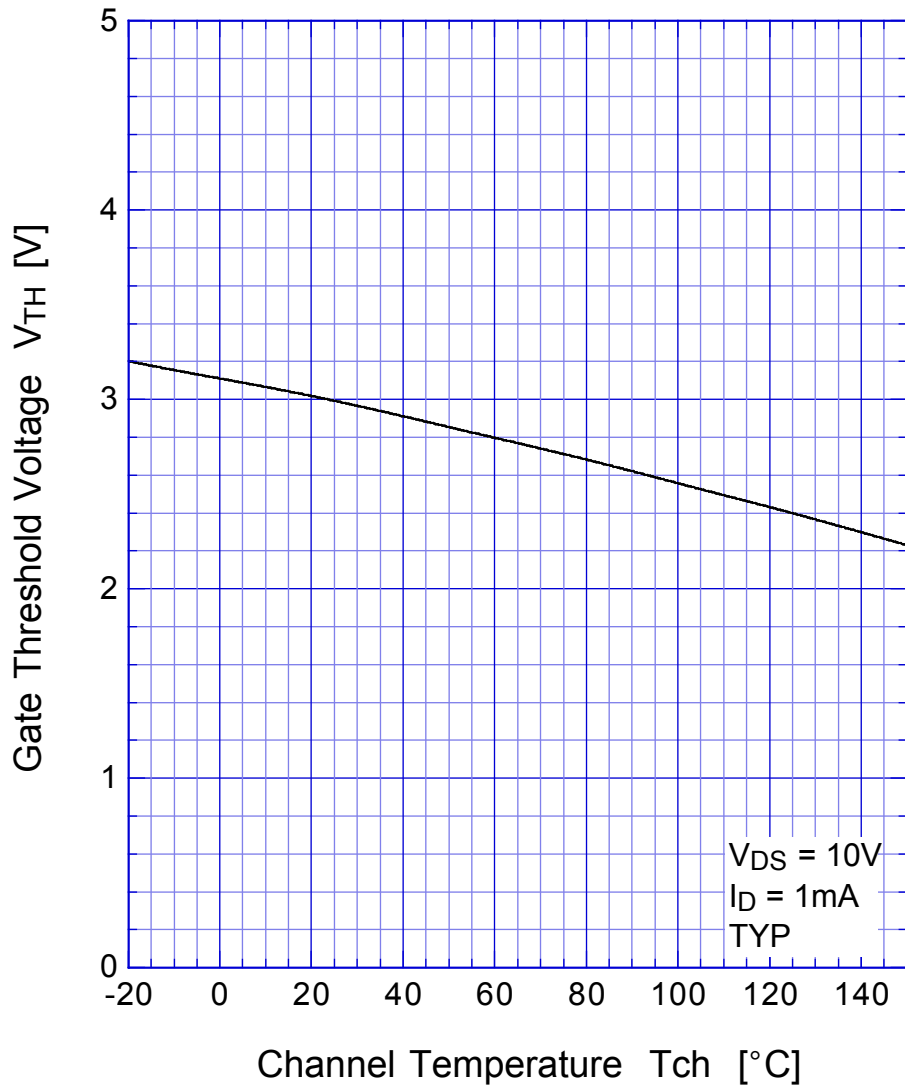

MA4510

Capacitance

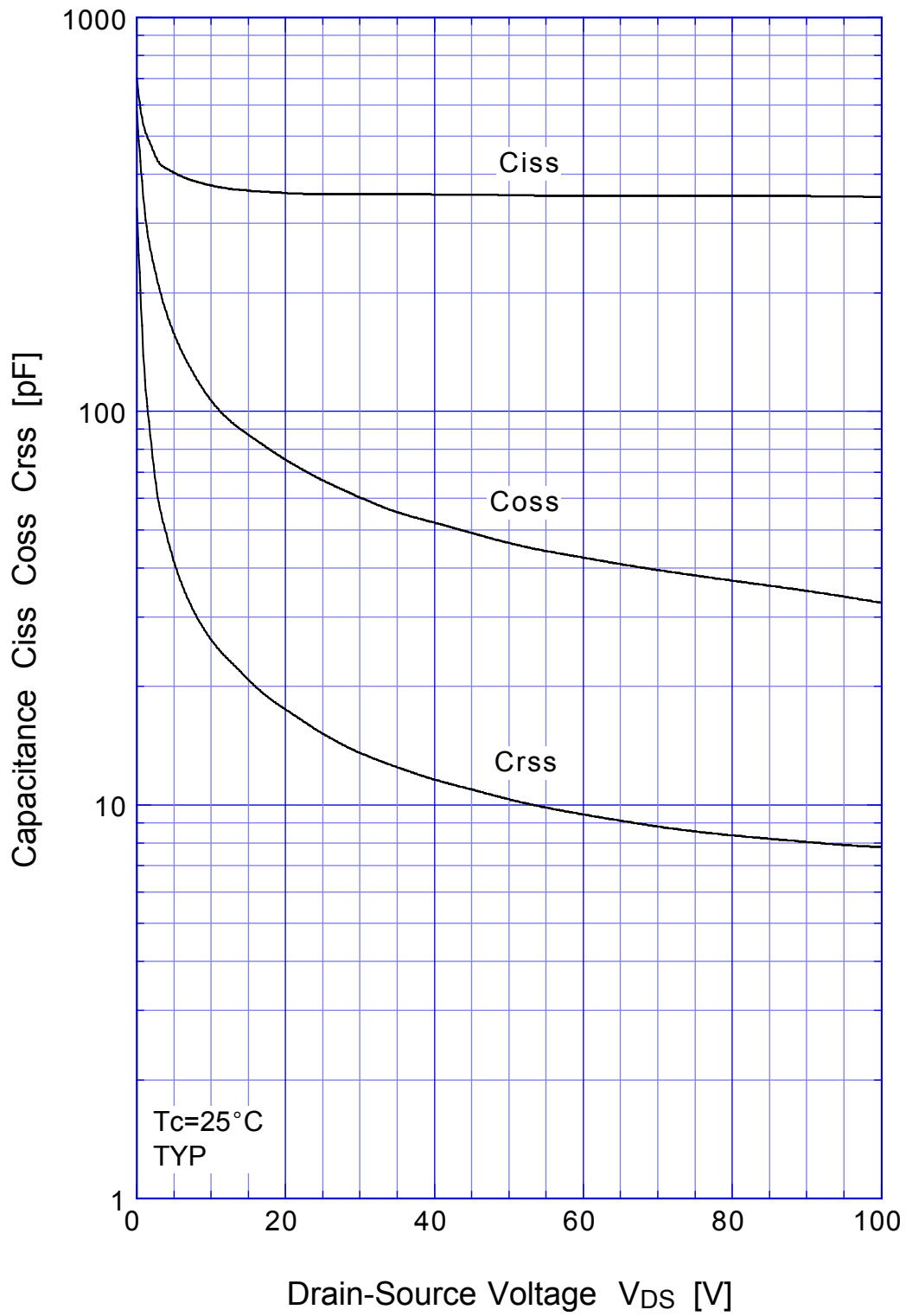

MA4510 Transient Thermal Impedance

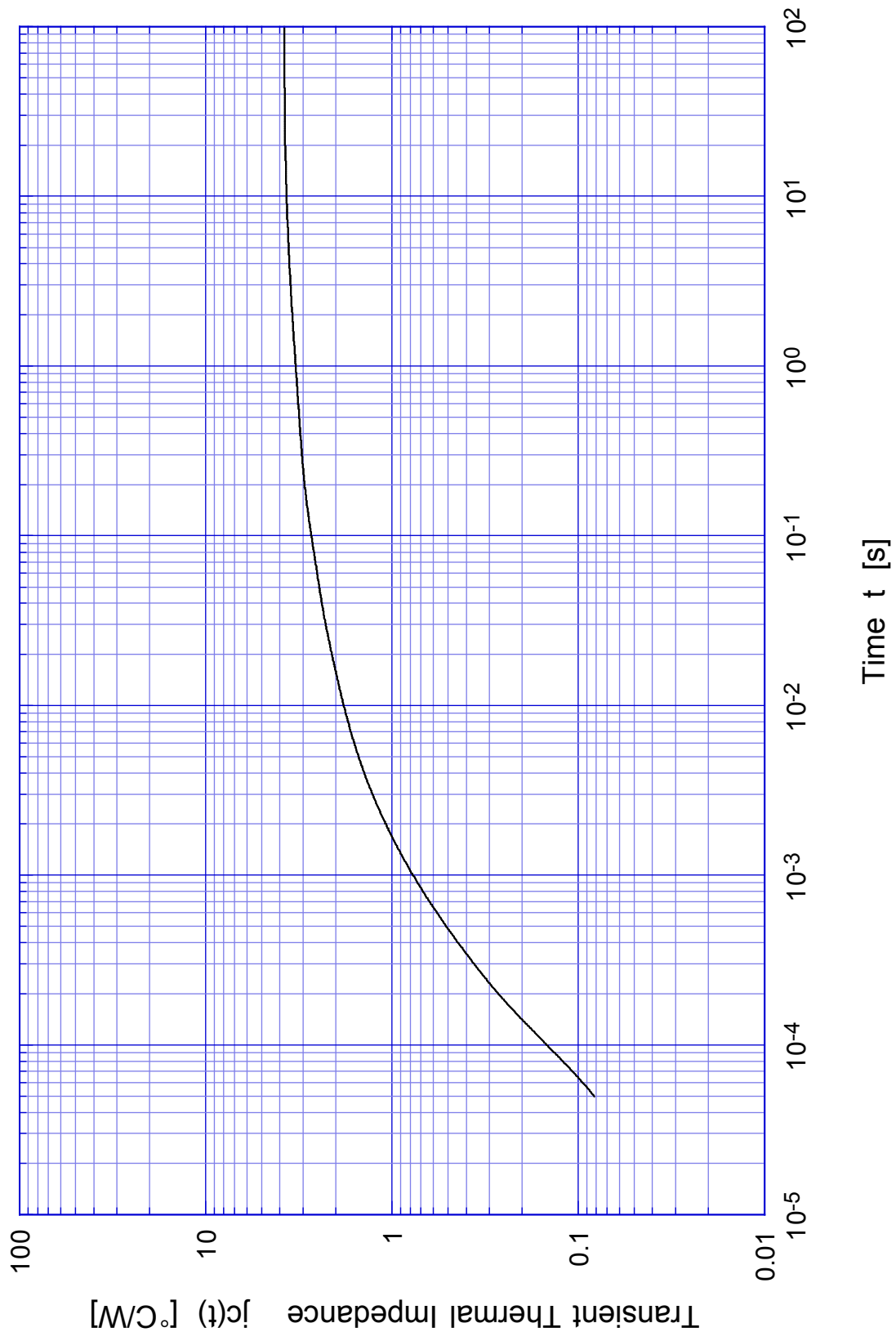

MA4510

Safe Operating Area

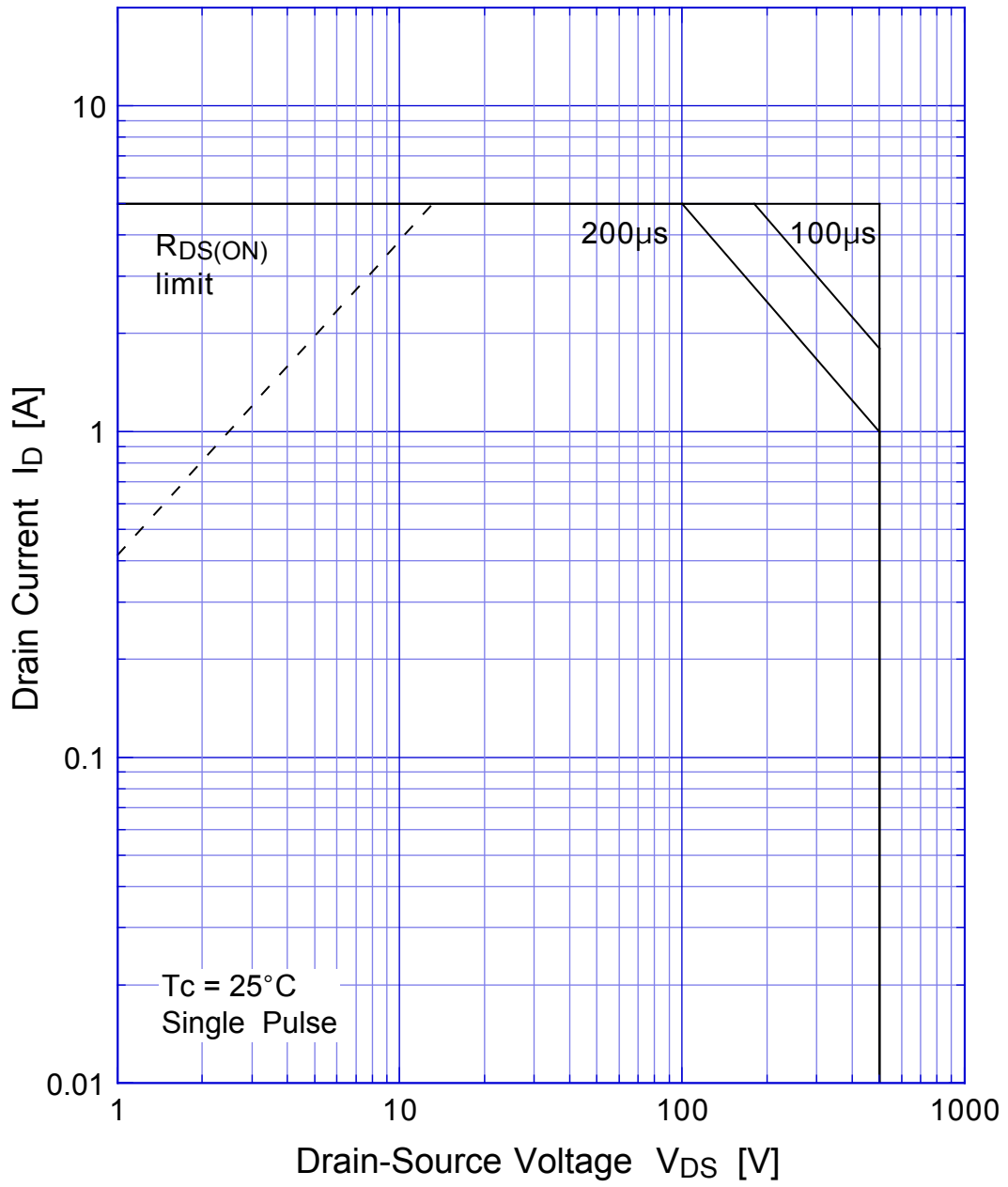

MA4510

Power Derating

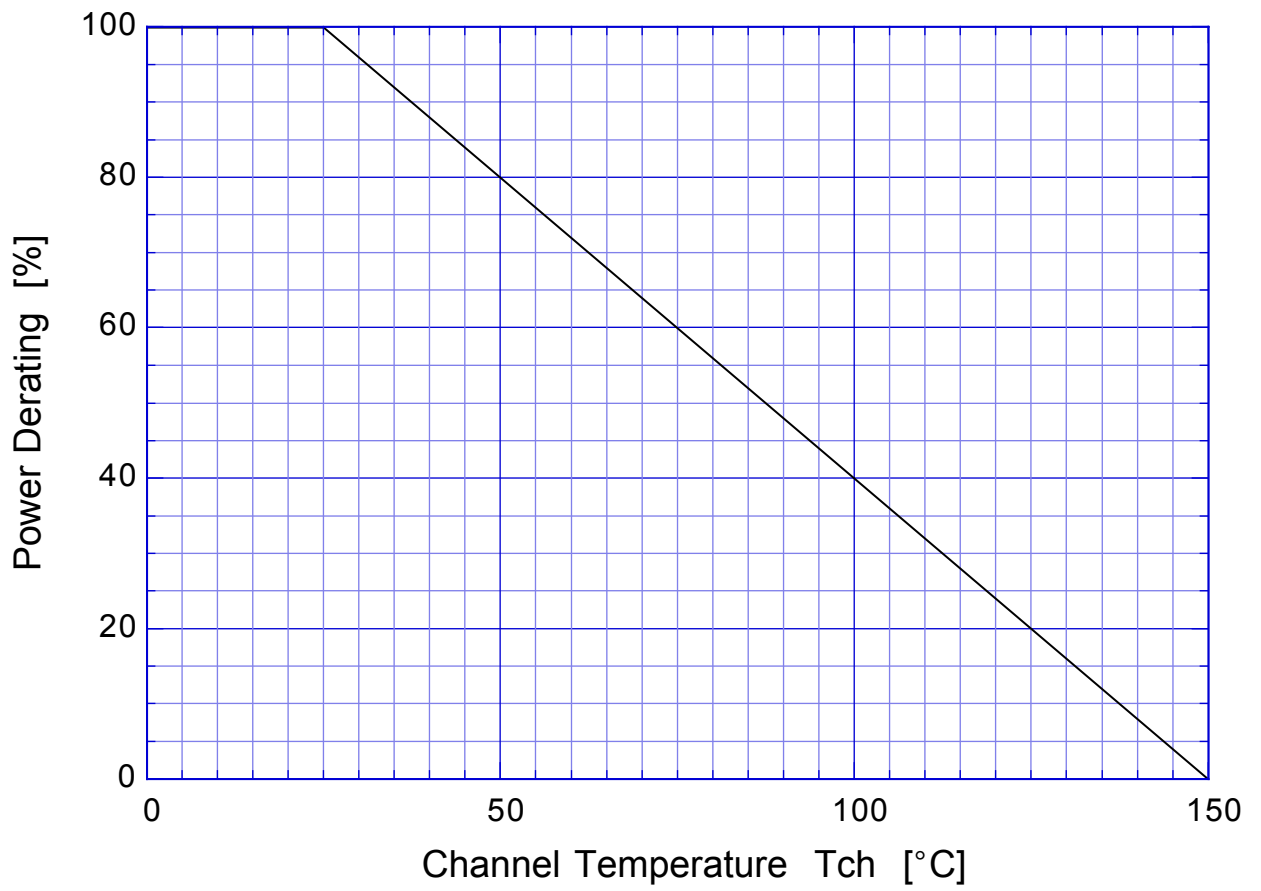

MA4510

Reverse Bias SOA

