

# SHINDENGEN

## Super Fast Recovery Rectifiers

Dual

# D5LD20U

**200V 5A**

### FEATURES

- Low noise
- trr35ns
- Fully Isolated Molding

### APPLICATION

- Switching power supply
- Free Wheel
- Home Appliances, Office Equipment
- Telecommunication, Factory Automation

### OUTLINE DIMENSIONS

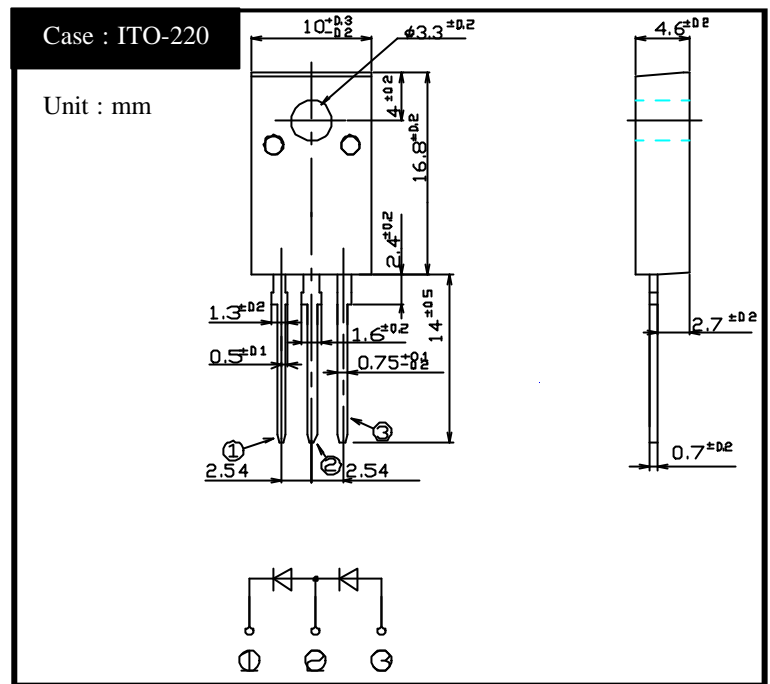

### RATINGS

Absolute Maximum Ratings (If not specified Tc=25 )

Item	Symbol	Conditions	Ratings	Unit
Storage Temperature	Tstg		-40 ~ 150	
Operating Junction Temperature	Tj		150	
Maximum Reverse Voltage	V <sub>RM</sub>		200	V
Average Rectified Forward Current	I <sub>O</sub>	50Hz sine wave, R-load, Rating for each diode I <sub>O</sub> /2, Tc=132	5.0	A
Peak Surge Forward Current	I <sub>FSM</sub>	50Hz sine wave. Non-repetitive 1 cycle peak value. Tj=25	45	A
Dielectric Strength	V <sub>djs</sub>	Terminals to case, AC 1 minute	1.5	kV
Mounting Torque	TOR	(Recommended torque 0.3N·m)	0.5	N·m

Electrical Characteristics (If not specified Tc=25 )

Item	Symbol	Conditions	Ratings	Unit
Forward Voltage	V <sub>F</sub>	I <sub>F</sub> =2.5A, Pulse measurement, Rating of per diode	Max.0.98	V
Reverse Current	I <sub>R</sub>	V <sub>R</sub> =V <sub>RM</sub> , Pulse measurement, Rating of per diode	Max.10	μA
Reverse Recovery Time	t <sub>rr</sub>	I <sub>F</sub> =0.5A, I <sub>R</sub> =1A, Rating of per diode	Max.35	ns
Thermal Resistance	jc	junction to case	Max.3.3	/W

# D5LD20U

## Forward Voltage

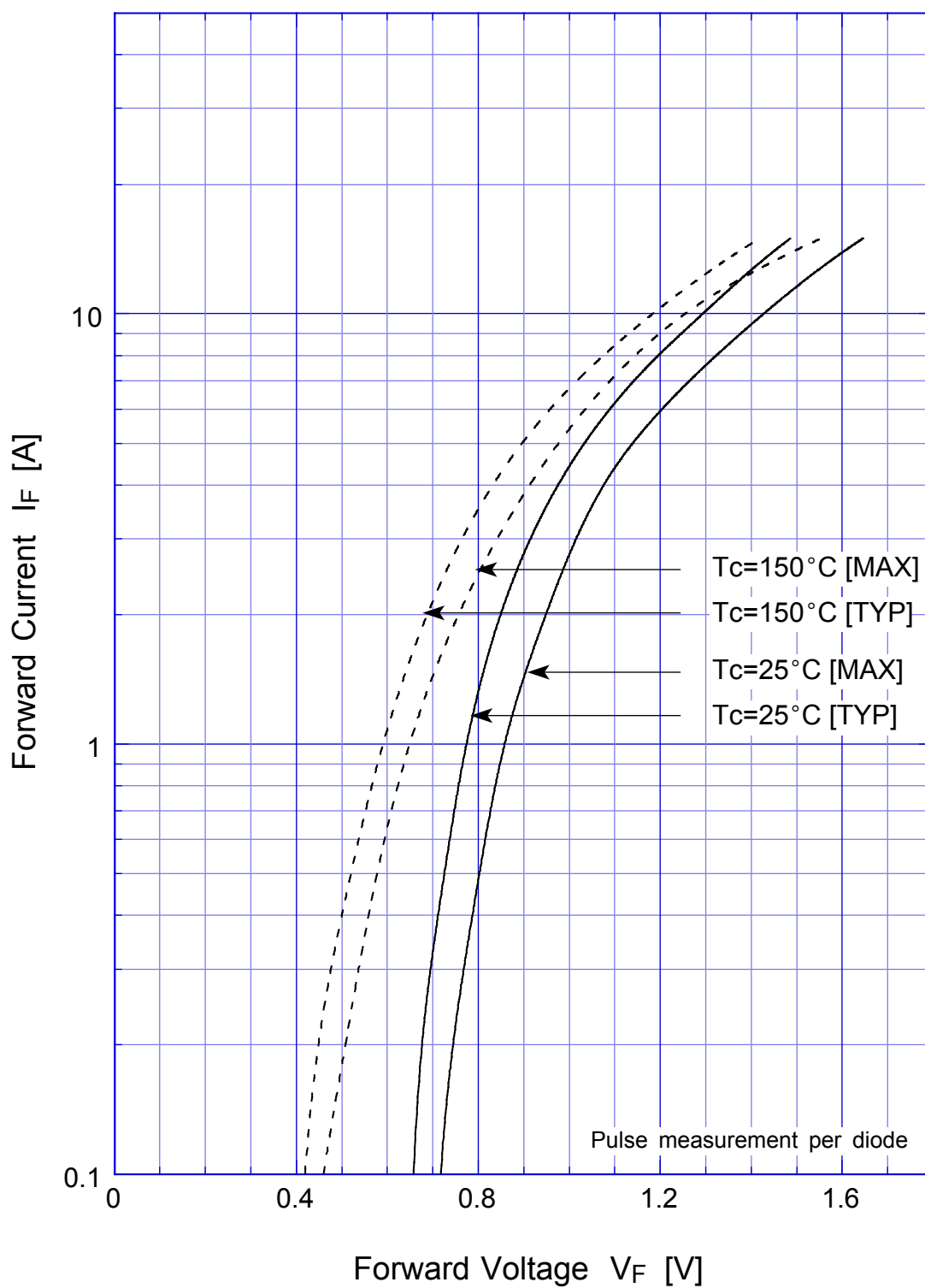

# D5LD20U Forward Power Dissipation

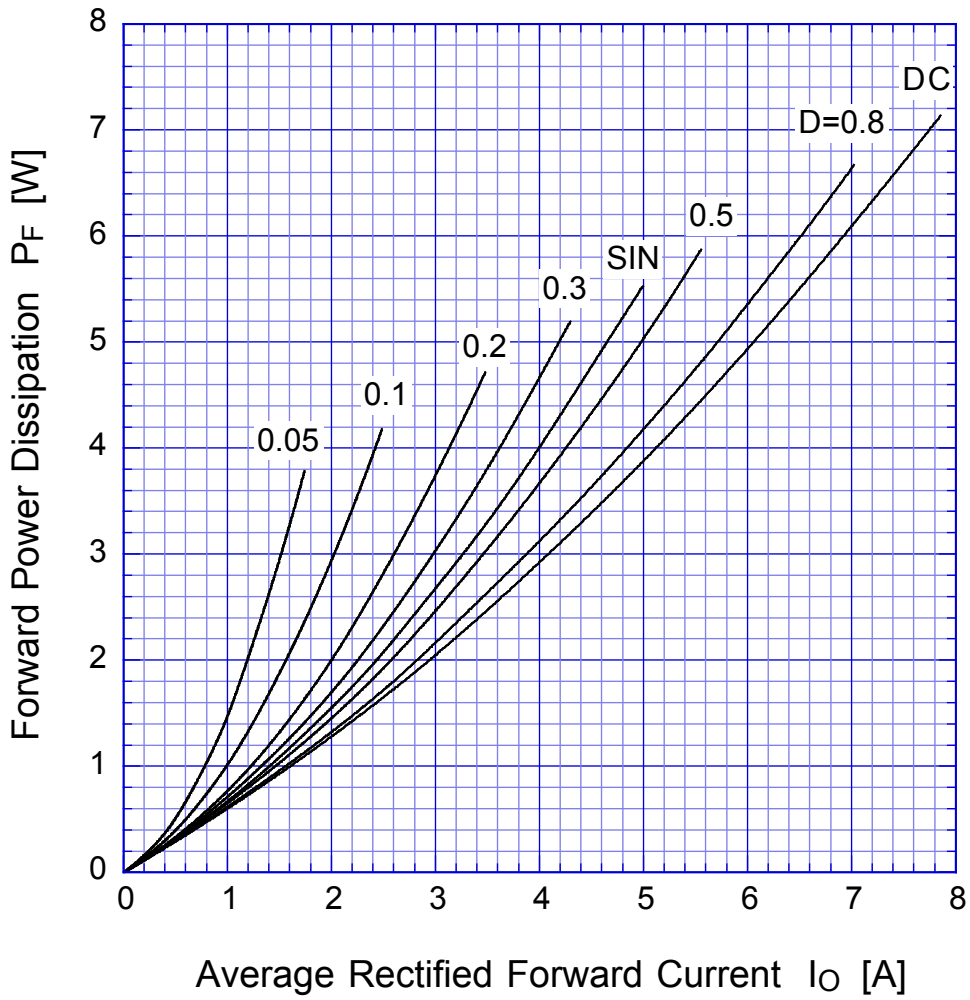

$T_j = 150^\circ\text{C}$

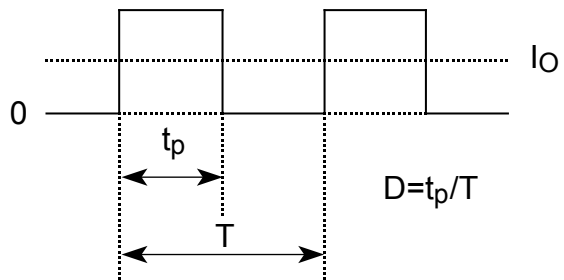

# D5LD20U

# Derating Curve

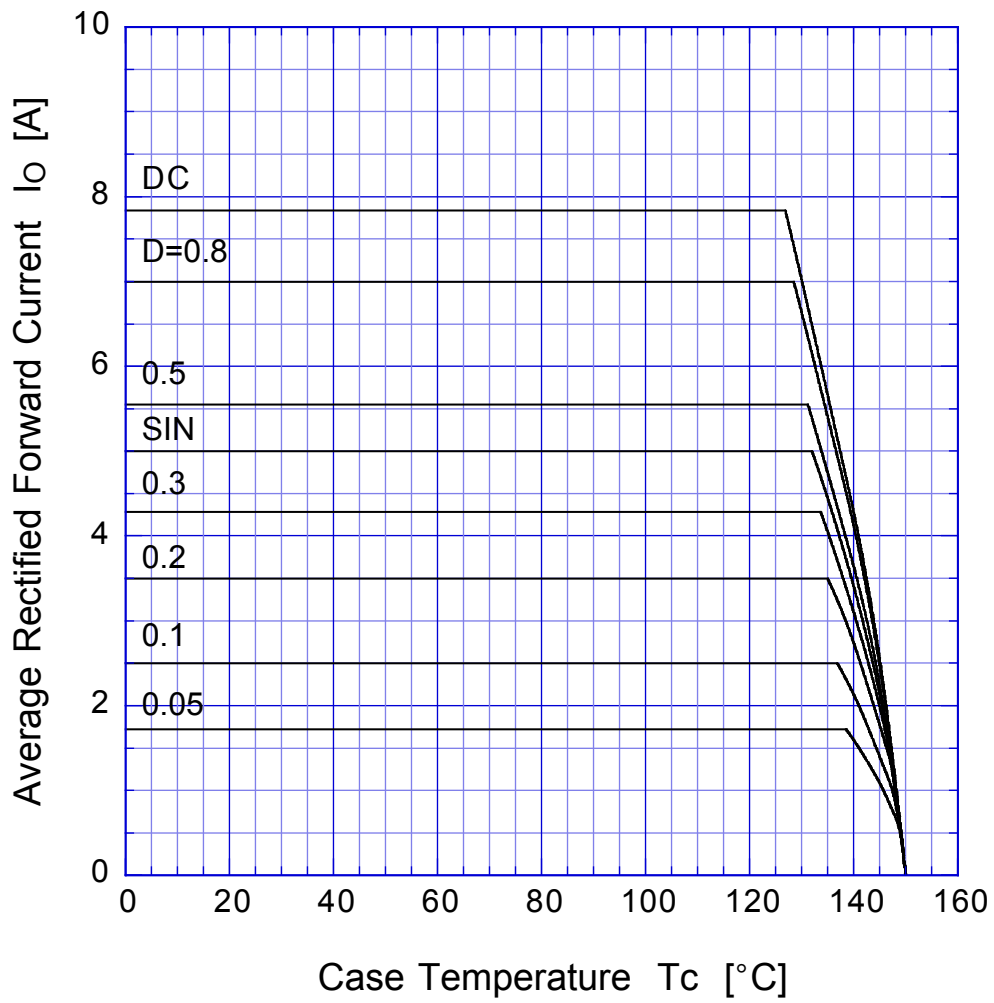

$$V_R = V_{RM}$$



# D5LD20U

# Derating Curve

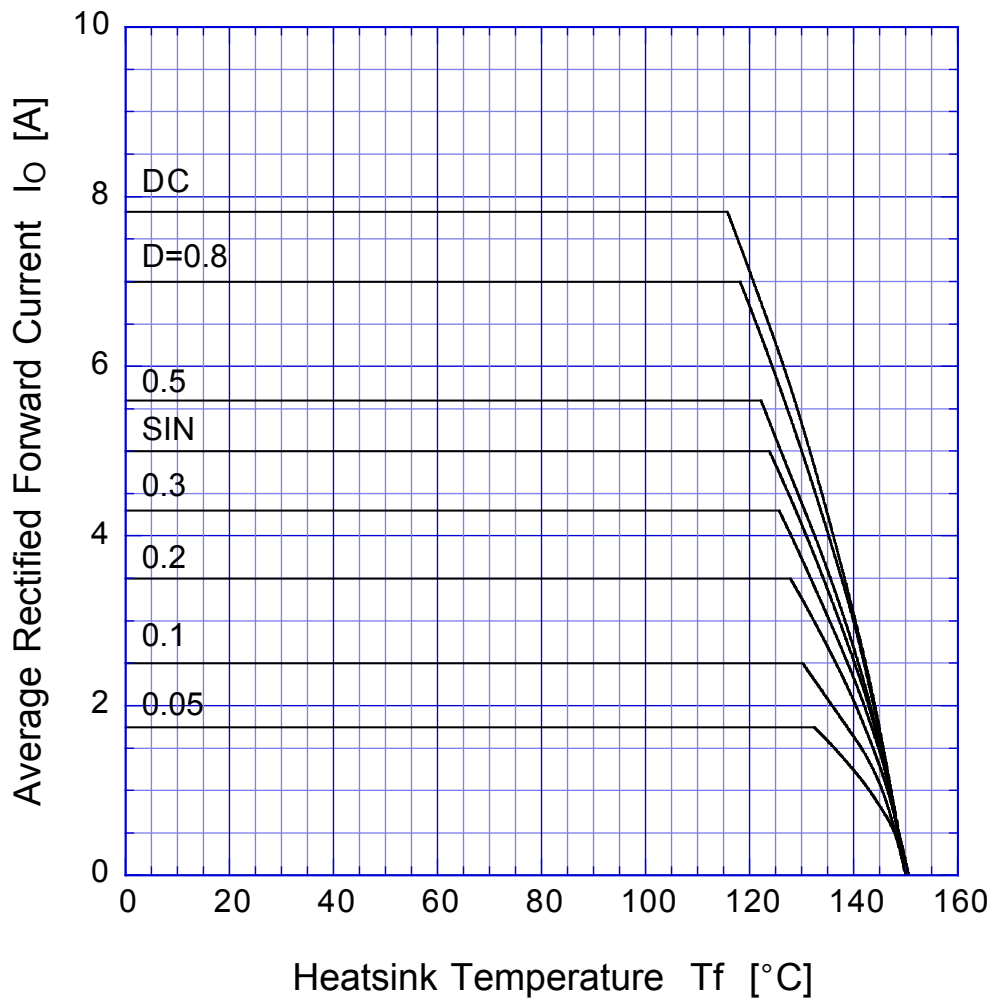

$$V_R = V_{RM}$$



# D5LD20U Peak Surge Forward Capability

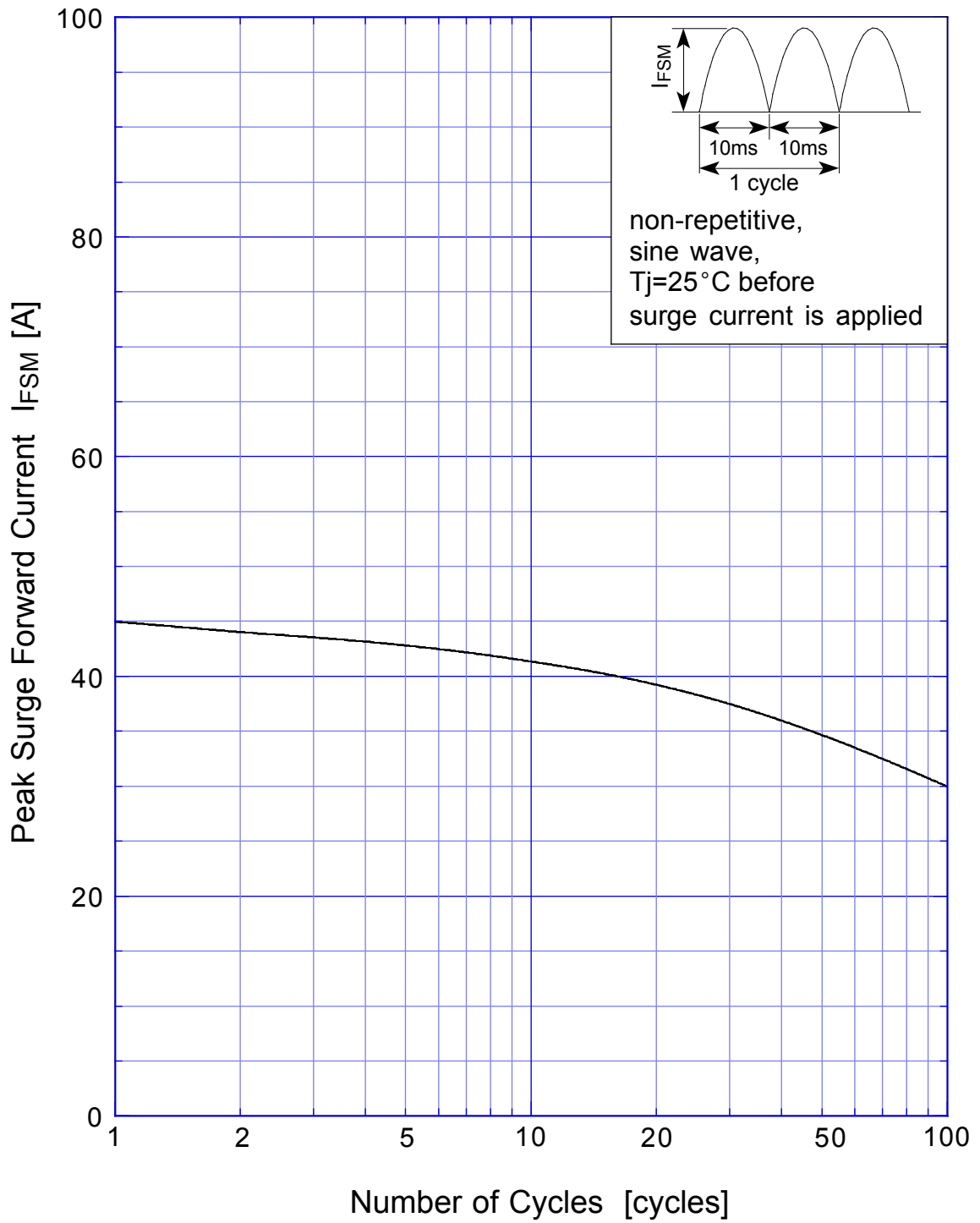

# D5LD20U Junction Capacitance

