

SHINDENGEN

Super Fast Recovery Rectifiers

Dual

D5LC20UR

200V 5A

FEATURES

- Low noise
- trr35ns
- Fully Isolated Molding

APPLICATION

- Switching power supply
- Free Wheel
- Home Appliances, Office Equipment
- Telecommunication, Factory Automation

OUTLINE DIMENSIONS

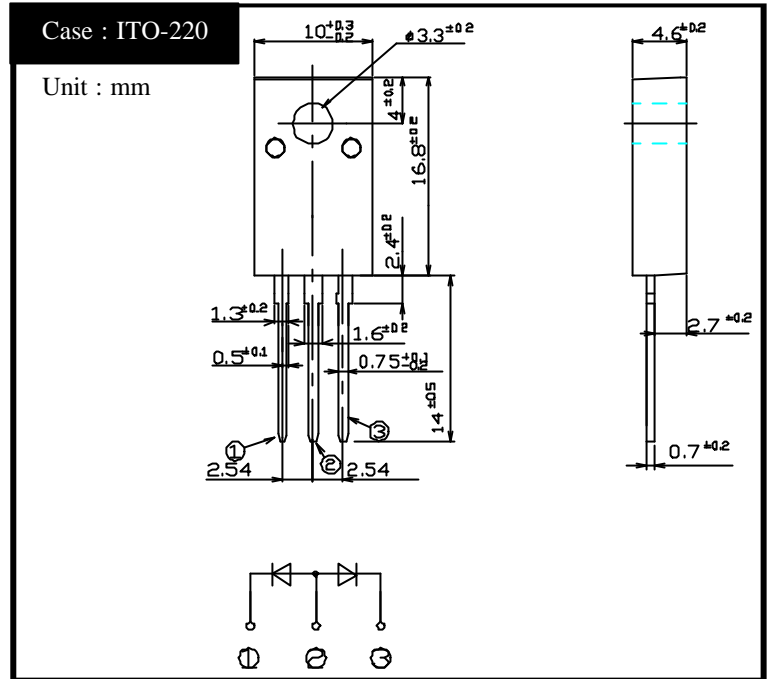

RATINGS

Absolute Maximum Ratings (If not specified $T_c=25$)

Item	Symbol	Conditions	Ratings	Unit
Storage Temperature	T_{stg}		-40 ~ 150	
Operating Junction Temperature	T_j		150	
Maximum Reverse Voltage	V_{RM}		200	V
Average Rectified Forward Current	I_o	50Hz sine wave, R-load, Rating for each diode $I_o/2$, $T_c=132$	5.0	A
Peak Surge Forward Current	I_{FSM}	50Hz sine wave, Non-repetitive 1 cycle peak value, $T_j=25$	45	A
Dielectric Strength	V_{dis}	Terminals to case, AC 1 minute	1.5	kV
Mounting Torque	TOR	(Recommended torque 0.3N·m)	0.5	N·m

Electrical Characteristics (If not specified $T_c=25$)

Item	Symbol	Conditions	Ratings	Unit
Forward Voltage	V_F	$I_F=2.5A$, Pulse measurement, Rating of per diode	Max.0.98	V
Reverse Current	I_R	$V_R=V_{RM}$, Pulse measurement, Rating of per diode	Max.10	μA
Reverse Recovery Time	trr	$I_F=0.5A$, $I_R=1A$, Rating of per diode	Max.35	ns
Thermal Resistance	θ_{jc}	junction to case	Max.3.3	/W

D5LC20UR Forward Voltage

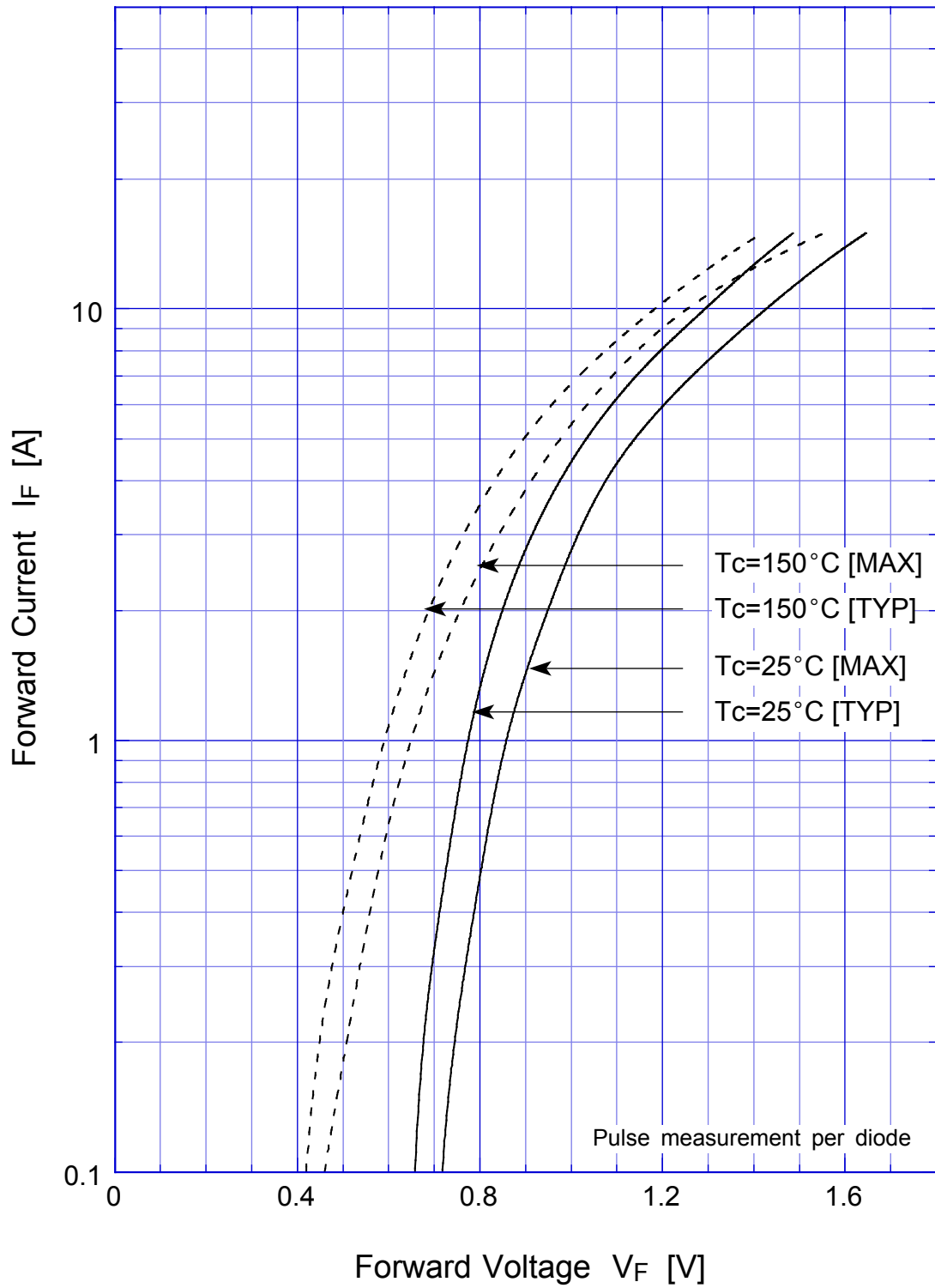

D5LC20UR Forward Power Dissipation

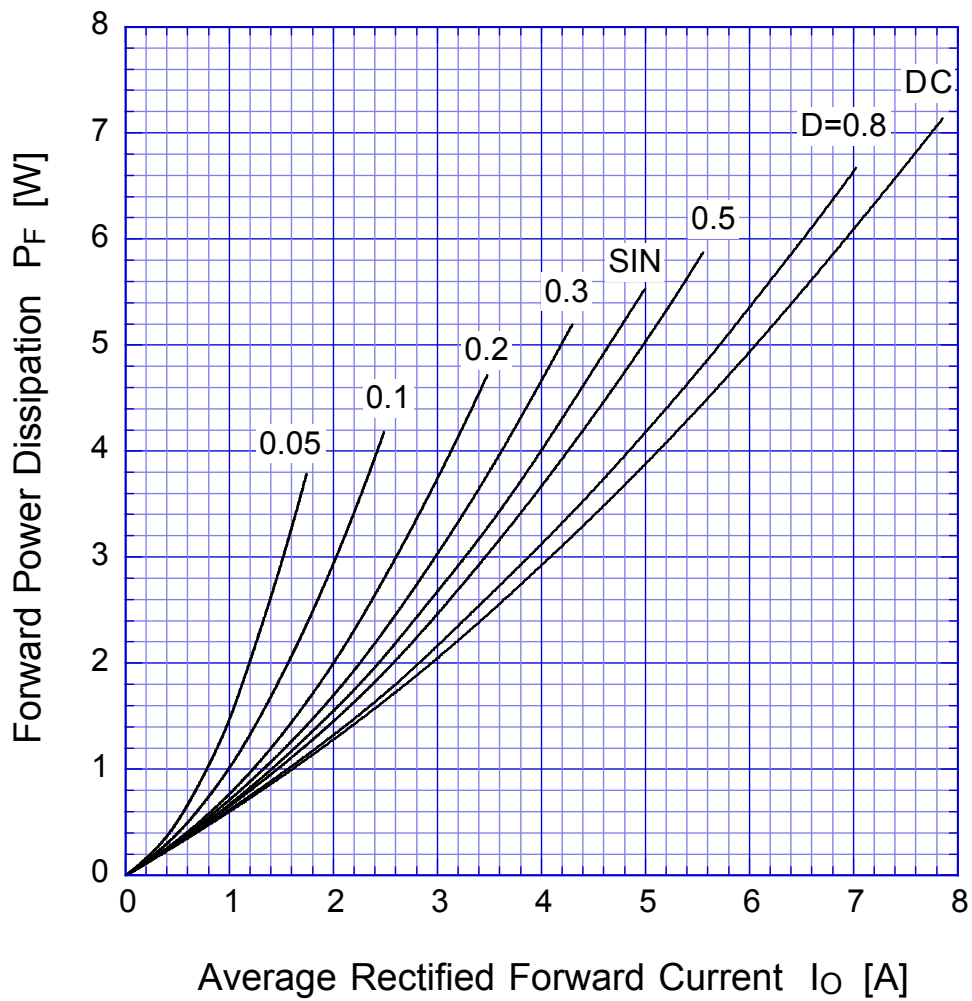

$T_j = 150^\circ\text{C}$

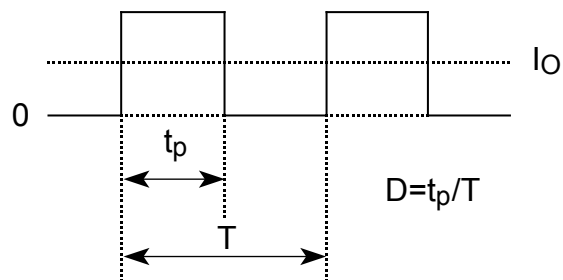

D5LC20UR

Derating Curve

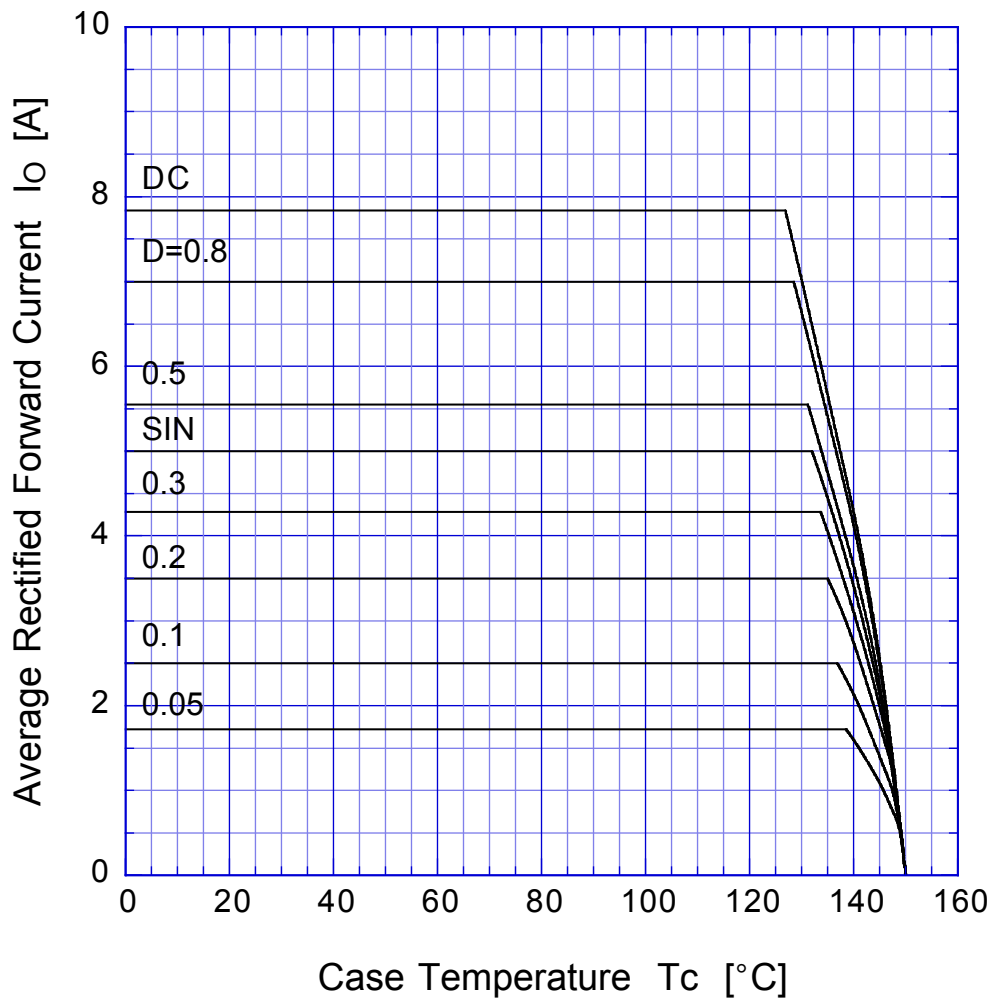

$$V_R = V_{RM}$$



D5LC20UR

Derating Curve

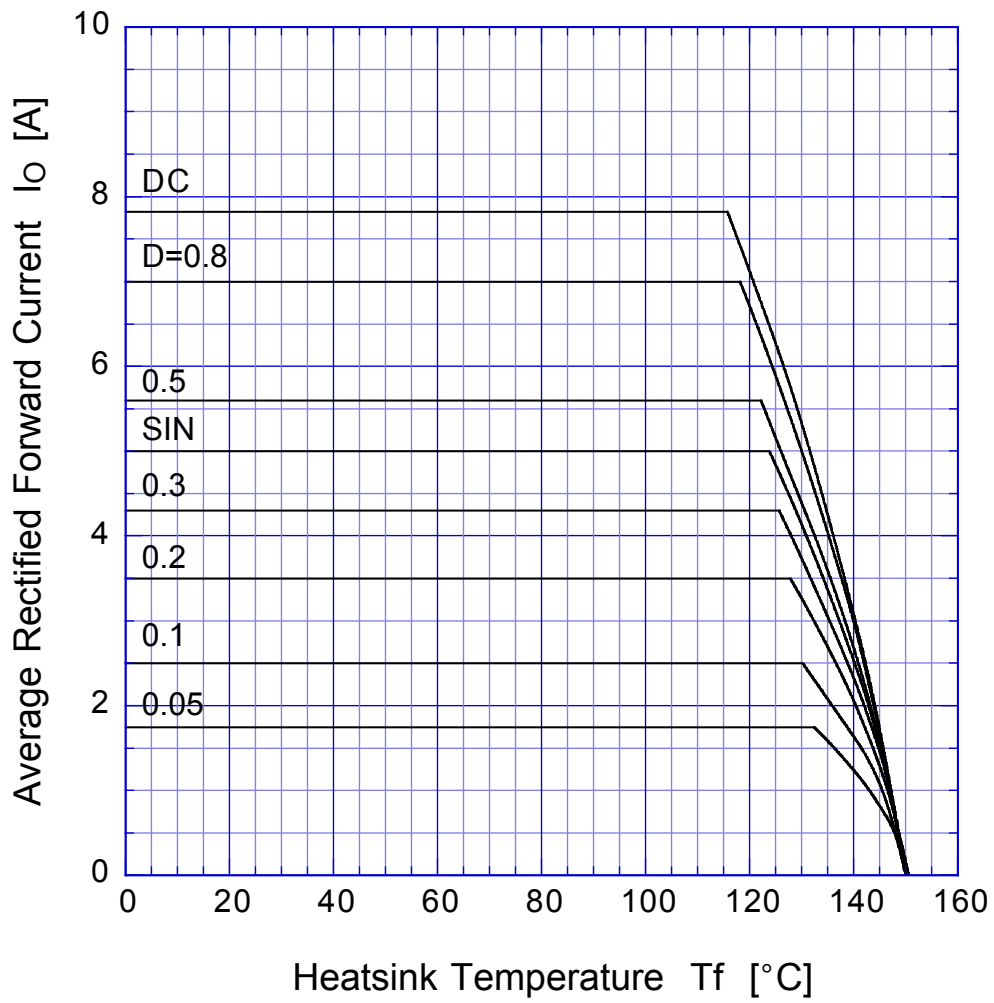

$$V_R = V_{RM}$$



D5LC20UR Peak Surge Forward Capability

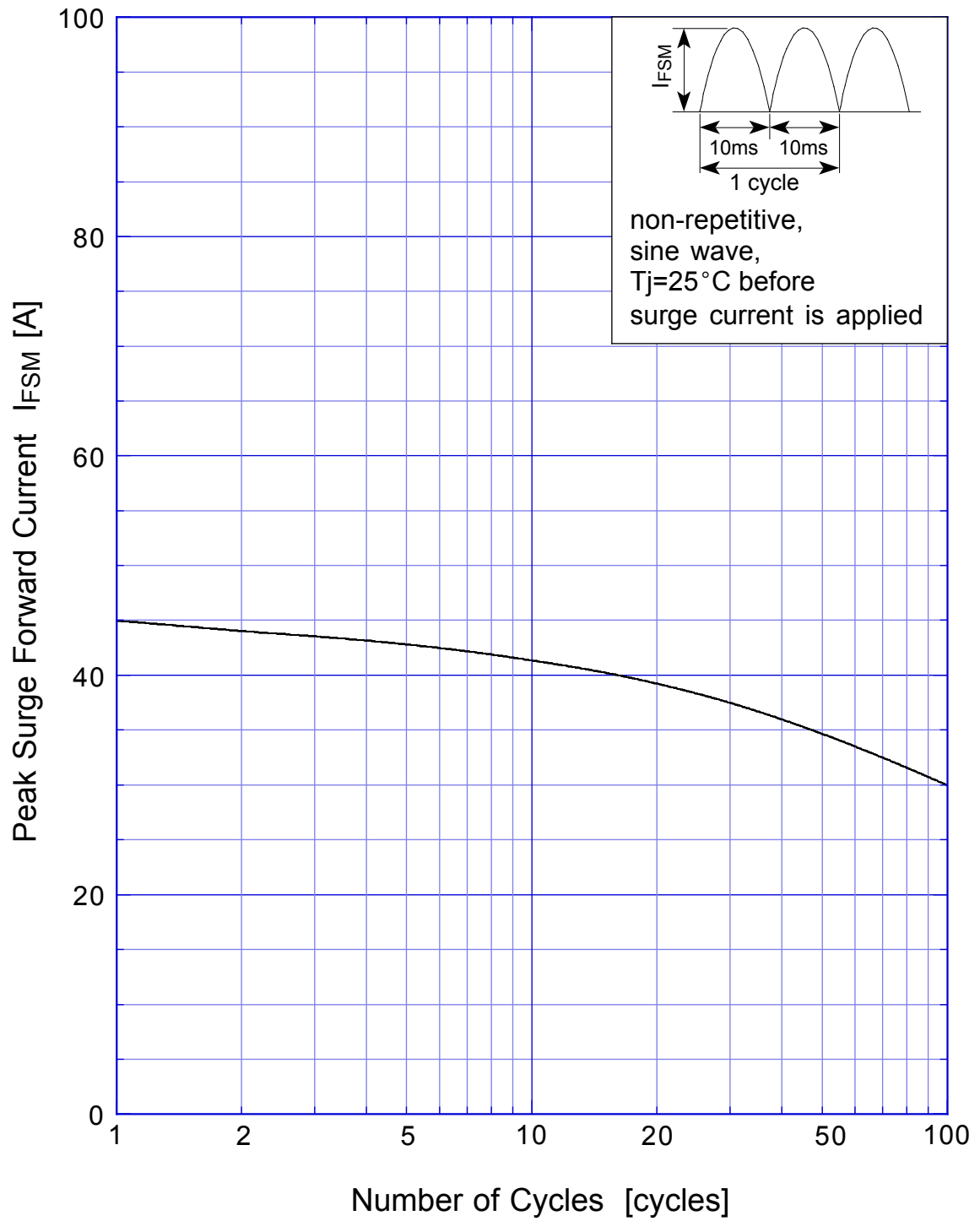

D5LC20UR Junction Capacitance

