

SHINDENGEN

Super Fast Recovery Rectifiers

Modules

D120LC40

400V 120A

FEATURES

High current capacity
trr100ns
Small jc

APPLICATION

Semiconductor Production Equipment
Big Power Supply
Factory Automation, Robot

OUTLINE DIMENSIONS

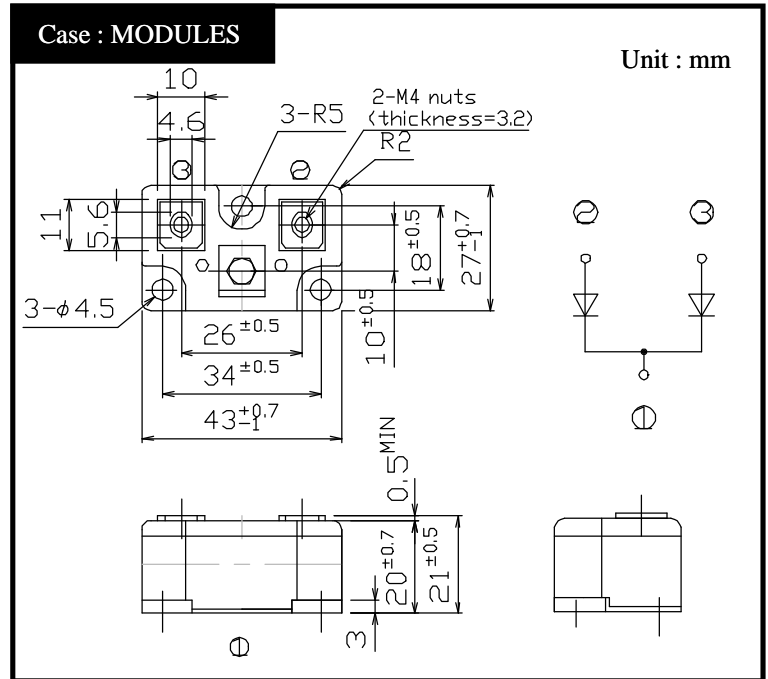

RATINGS

Absolute Maximum Ratings (If not specified Tc=25)

Item	Symbol	Conditions	Ratings	Unit
Storage Temperature	Tstg		-40 ~ 150	
Operating Junction Temperature	Tj		150	
Maximum Reverse Voltage	V _{RM}		400	V
Average Rectified Forward Current	I _O	50Hz sine wave, R-load, Rating for each arm I _o /2, Tc=95	120	A
Peak Surge Forward Current	I _{FSM}	50Hz sine wave, Non-repetitive 1cycle peak value, Rating of per arm Tj=25	650	A
Mounting Torque	TOR		1.7	N·m

Electrical Characteristics (If not specified Tc=25)

Item	Symbol	Conditions	Ratings	Unit
Forward Voltage	V _F	I _F =60A, Pulse measurement, Rating of per arm	Max.1.3	V
Reverse Current	I _R	V _R =V _{RM} , Pulse measurement, Rating of per arm	Max.25	μA
Reverse Recovery Time	trr	I _F =0.5A, I _R =1A, Rating of per arm	Max.100	ns
Thermal Resistance	jc	junction to case	Max.0.31	/W

D120LC40 Forward Voltage

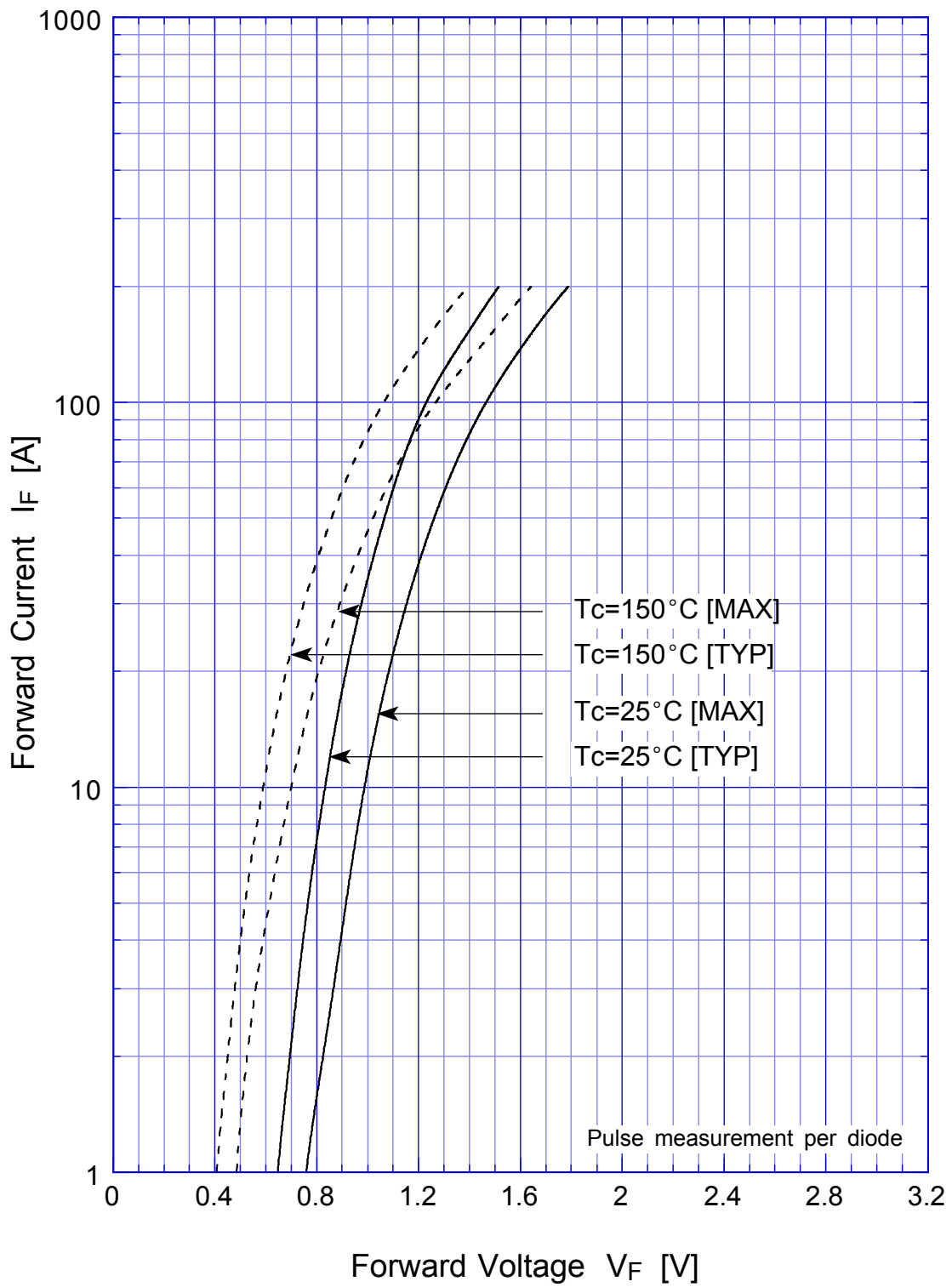

D120LC40 Forward Power Dissipation

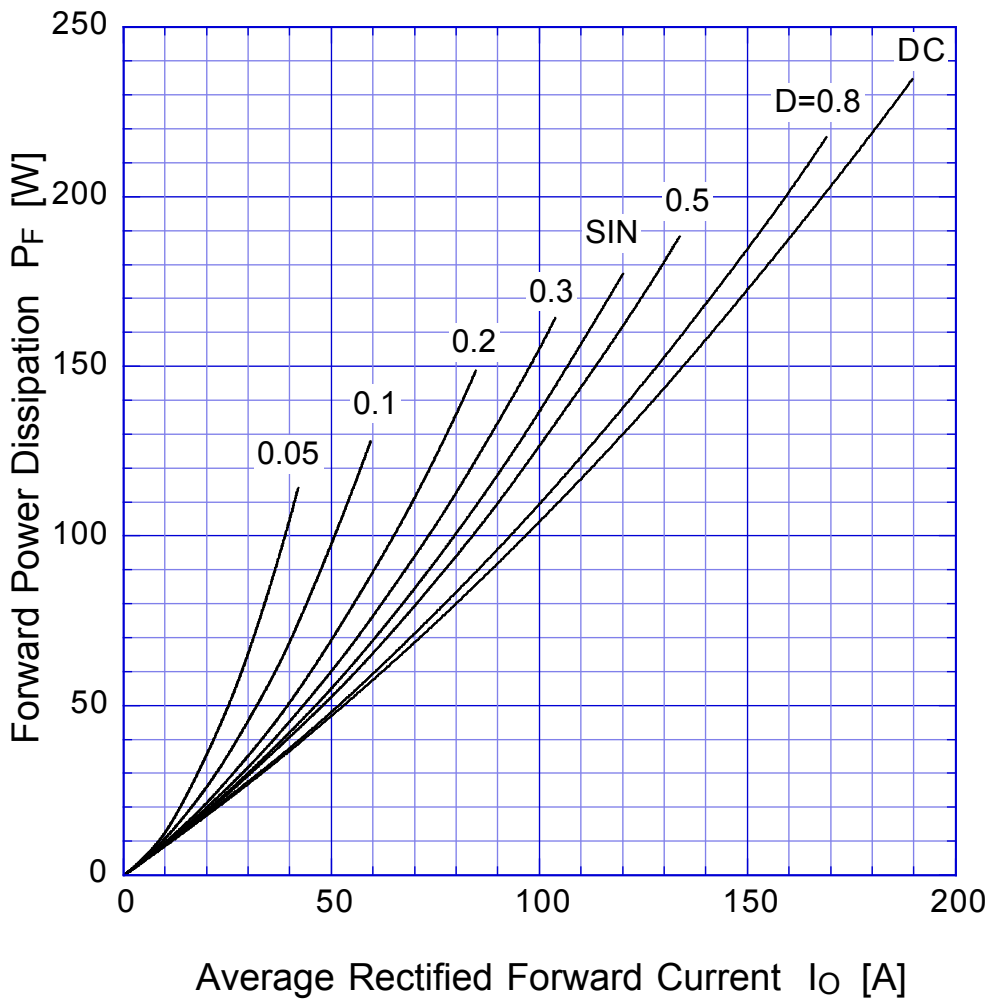

$T_j = T_{jmax}$

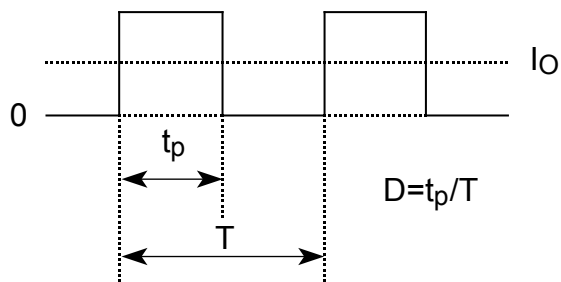

D120LC40

Derating Curve

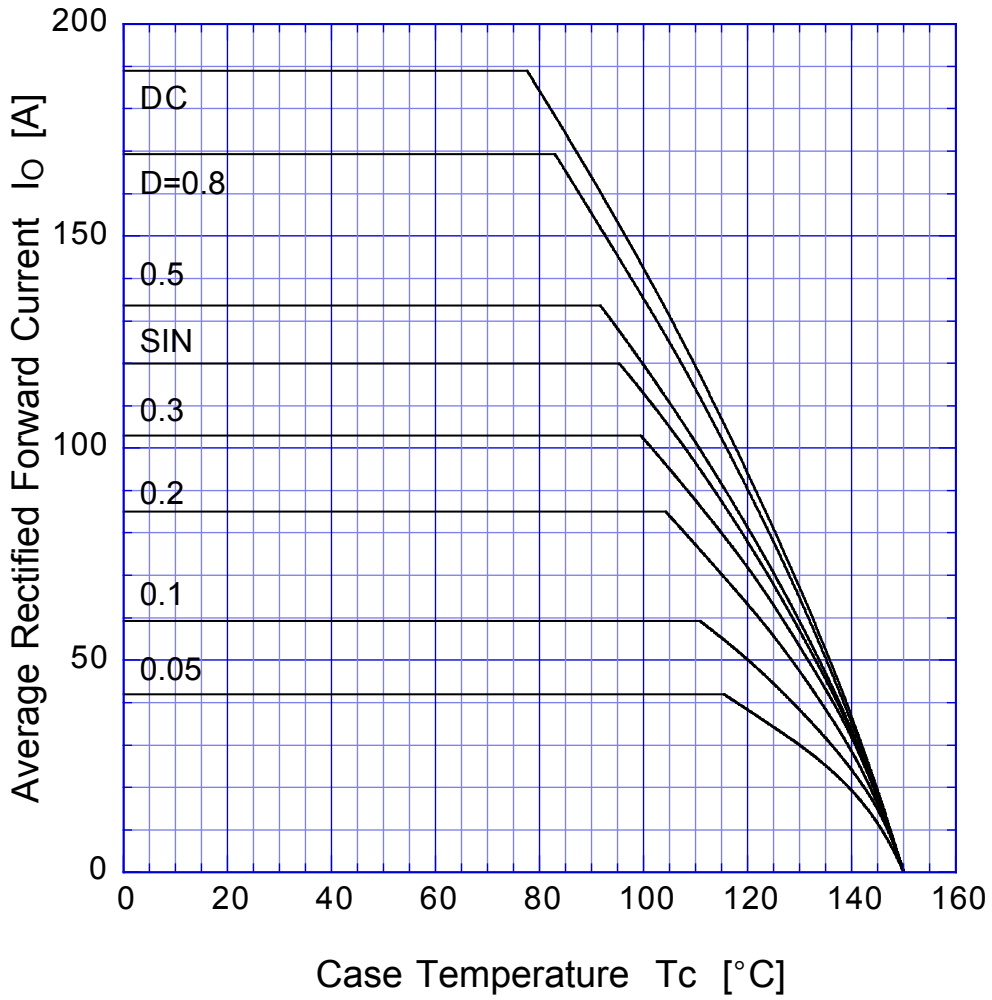

$$V_R = V_{RM}$$

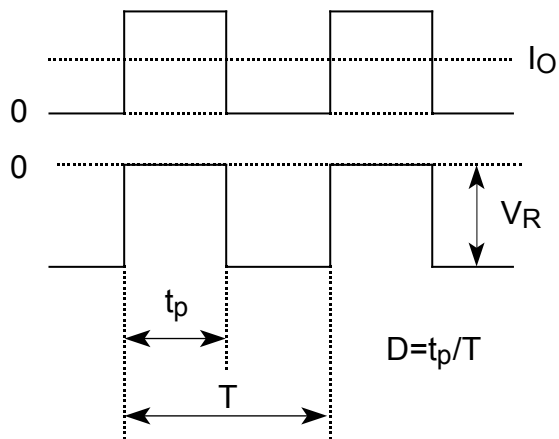

D120LC40 Peak Surge Forward Capability

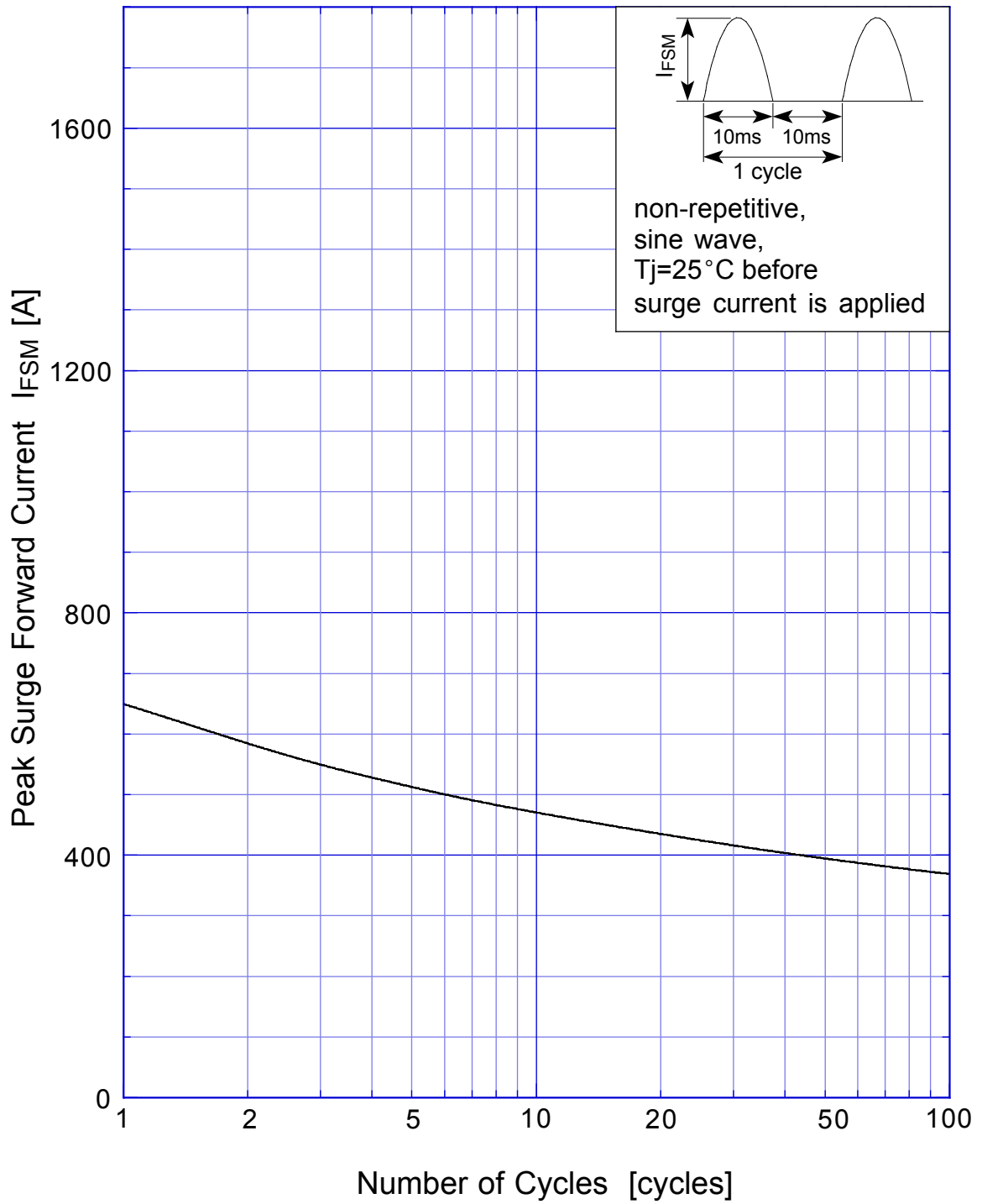

D120LC40 Junction Capacitance

