

SHINDENGEN

Super Fast Recovery Rectifiers

Single

D1NL40

400V 0.9 A

FEATURES

- Low noise
- trr50ns
- 5 mm pitch mounting applicable

APPLICATION

- Switching power supply
- Free Wheel
- Home Appliances, Office Equipment
- Telecommunication, Factory Automation

OUTLINE DIMENSIONS

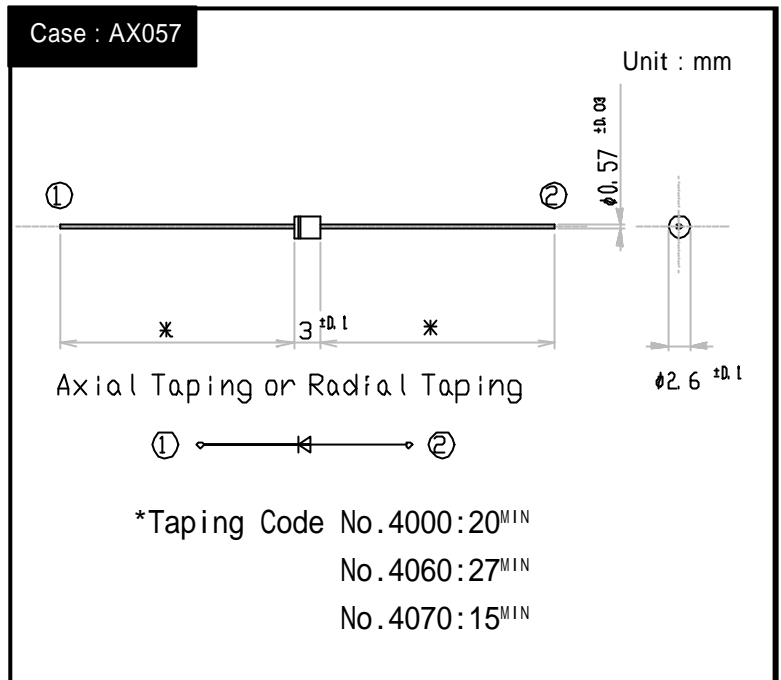

RATINGS

Absolute Maximum Ratings (If not specified Tl=25)

Item	Symbol	Conditions	Ratings	Unit
Storage Temperature	Tstg		-55 ~ 150	
Operating Junction Temperature	Tj		150	
Maximum Reverse Voltage	V _{RM}		400	V
Average Rectified Forward Current	I _O	50Hz sine wave, R-load, Ta=25	0.9	A
Peak Surge Forward Current	I _{FSM}	50Hz sine wave, Non-repetitive 1 cycle peak value, Tj=25	25	A

Electrical Characteristics (If not specified Tl=25)

Item	Symbol	Conditions	Ratings	Unit
Forward Voltage	V _F	I _F =0.9A, Pulse measurement	Max.1.3	V
Reverse Current	I _R	V _R =V _{RM} , Pulse measurement	Max.10	μA
Reverse Recovery Time	trr	I _F =0.5A, I _R =1A	Max.50	ns
Thermal Resistance	jl	junction to lead	Max.10	/W
	ja	junction to ambient, On P.C.B. Lead length=5mm	Max.113	

D1NL40

Forward Voltage

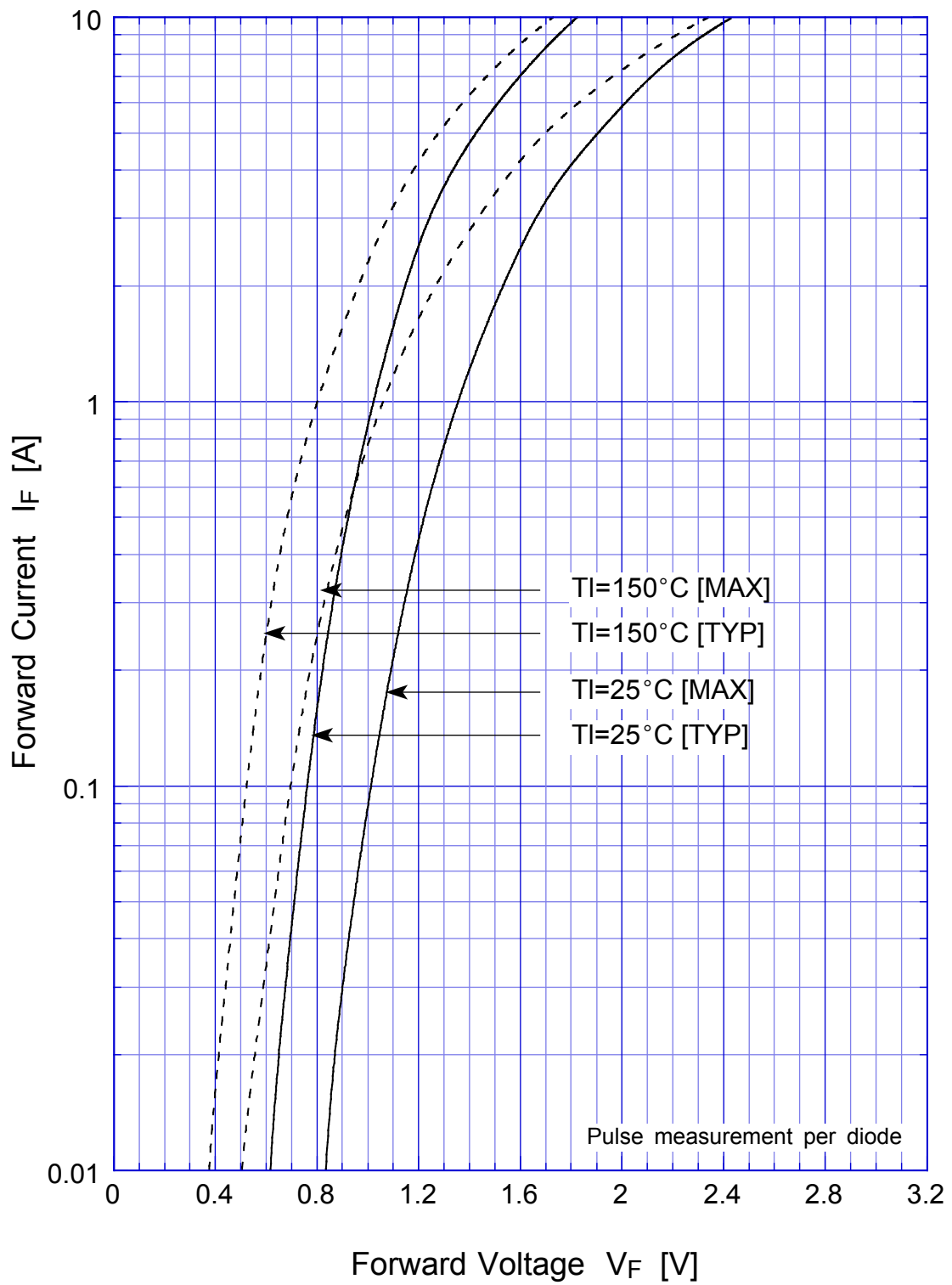

D1NL40

Forward Power Dissipation

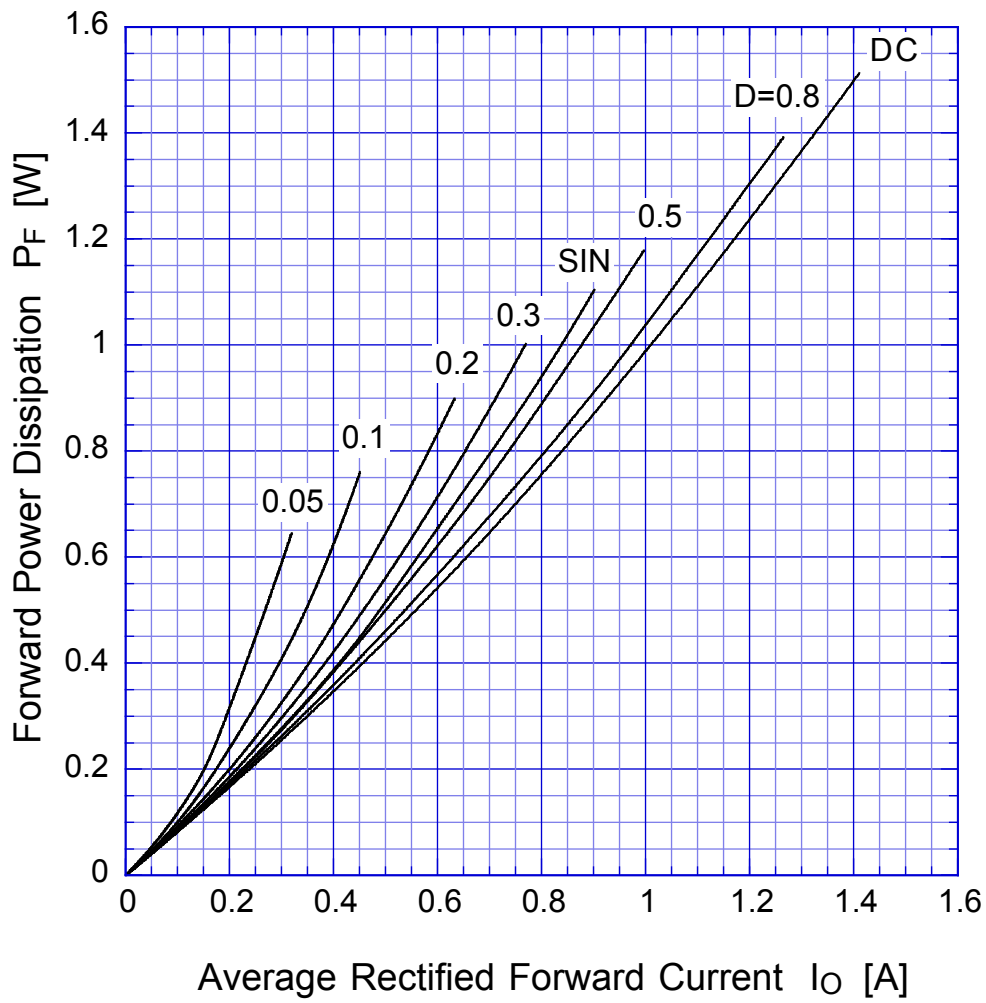

$T_j = T_{jmax}$

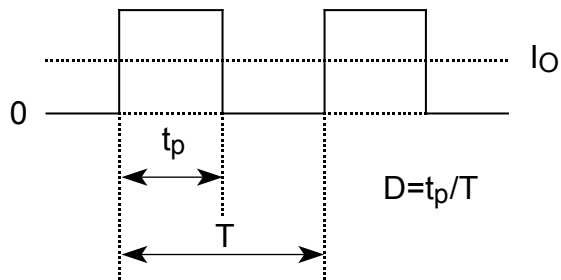

D1NL40

Derating Curve

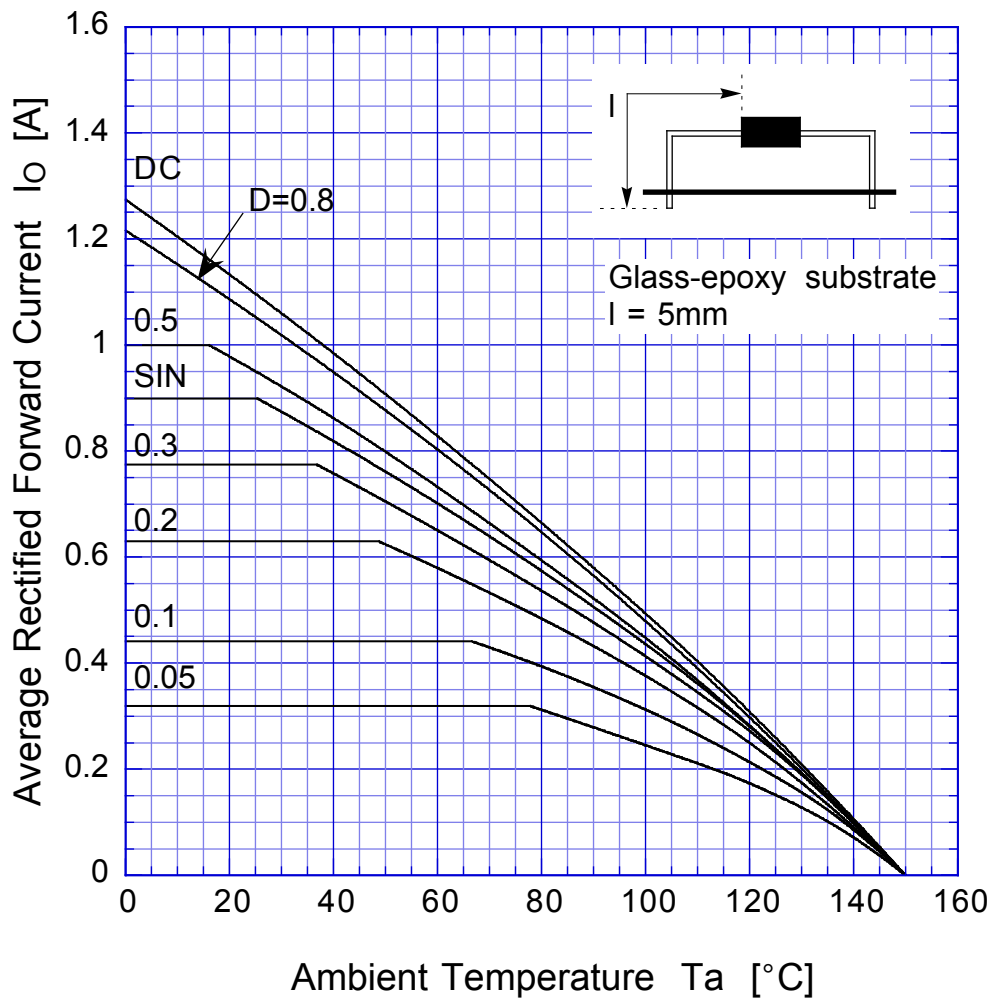

$$V_R = V_{RM}$$

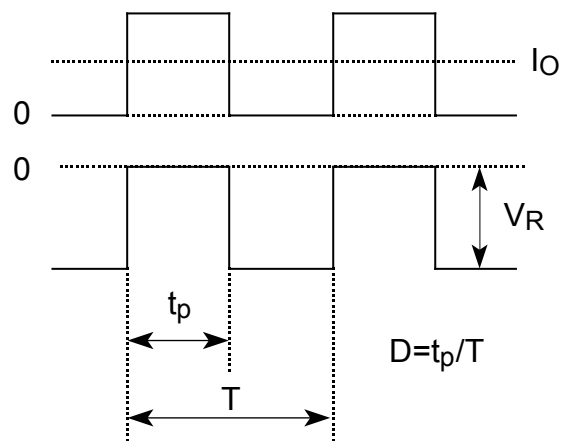

D1NL40

Peak Surge Forward Capability

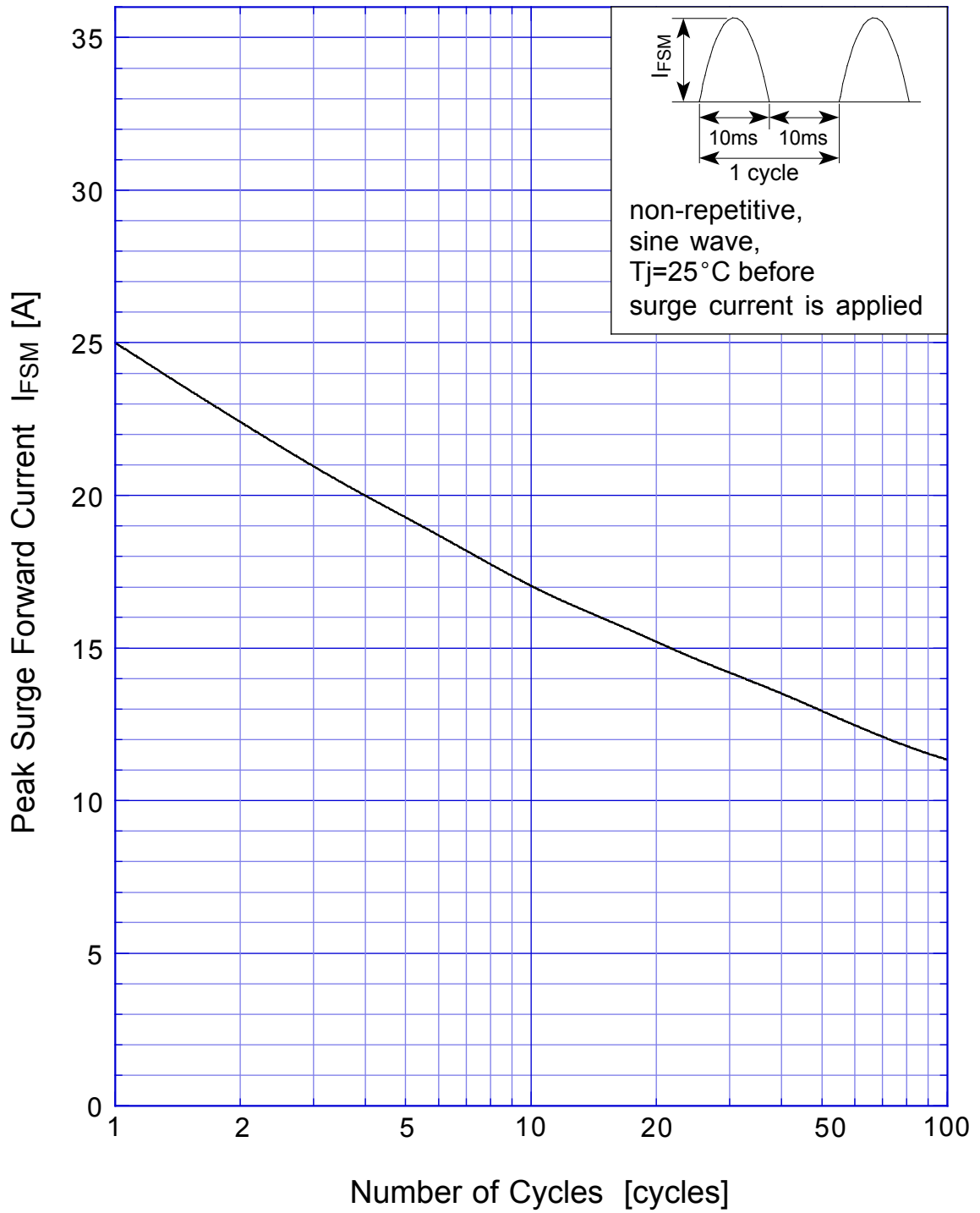

D1NL40 Junction Capacitance

