

SHINDENGEN

Super Fast Recovery Rectifiers

Single

D2FL20U

200V 1.5A

FEATURES

Small SMT
Low noise
trr35ns

APPLICATION

Switching power supply
DC/DC converter
Free Wheel
Home Appliances, Office Equipment
Telecommunication, Factory Automation

OUTLINE DIMENSIONS

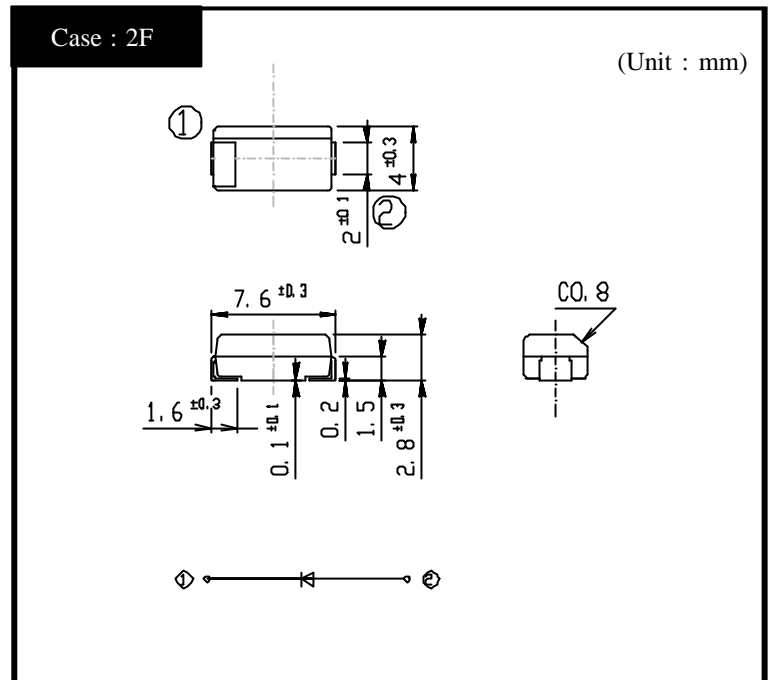

RATINGS

Absolute Maximum Ratings (If not specified $T_I=25$)

Item	Symbol	Conditions	Ratings	Unit
Storage Temperature	T_{stg}		-55 ~ 150	
Operating Junction Temperature	T_j		150	
Maximum Reverse Voltage	V_{RM}		200	V
Average Rectified Forward Current	I_o	50Hz sine wave, R-load, $T_a=25$ On alumina substrate	1.5	A
		50Hz sine wave, R-load, $T_a=25$ On glass-epoxy substrate	1.2	
Peak Surge Forward Current	I_{FSM}	50Hz sine wave, Non-repetitive 1 cycle peak value, $T_j=25$	50	A

Electrical Characteristics (If not specified $T_I=25$)

Item	Symbol	Conditions	Ratings	Unit
Forward Voltage	V_F	$I_F=1.5A$, Pulse measurement	Max.0.98	V
Reverse Current	I_R	$V_R=V_{RM}$, Pulse measurement	Max.10	μA
Reverse Recovery Time	t_{rr}	$I_F=0.5A$, $I_R=1A$	Max.35	ns
Thermal Resistance	θ_{jl}	junction to lead	Max.24	/W
	θ_{ja}	junction to ambient, On alumina substrate	Max.90	
		junction to ambient, On glass-epoxy substrate	Max.120	

D2FL20U

Forward Voltage

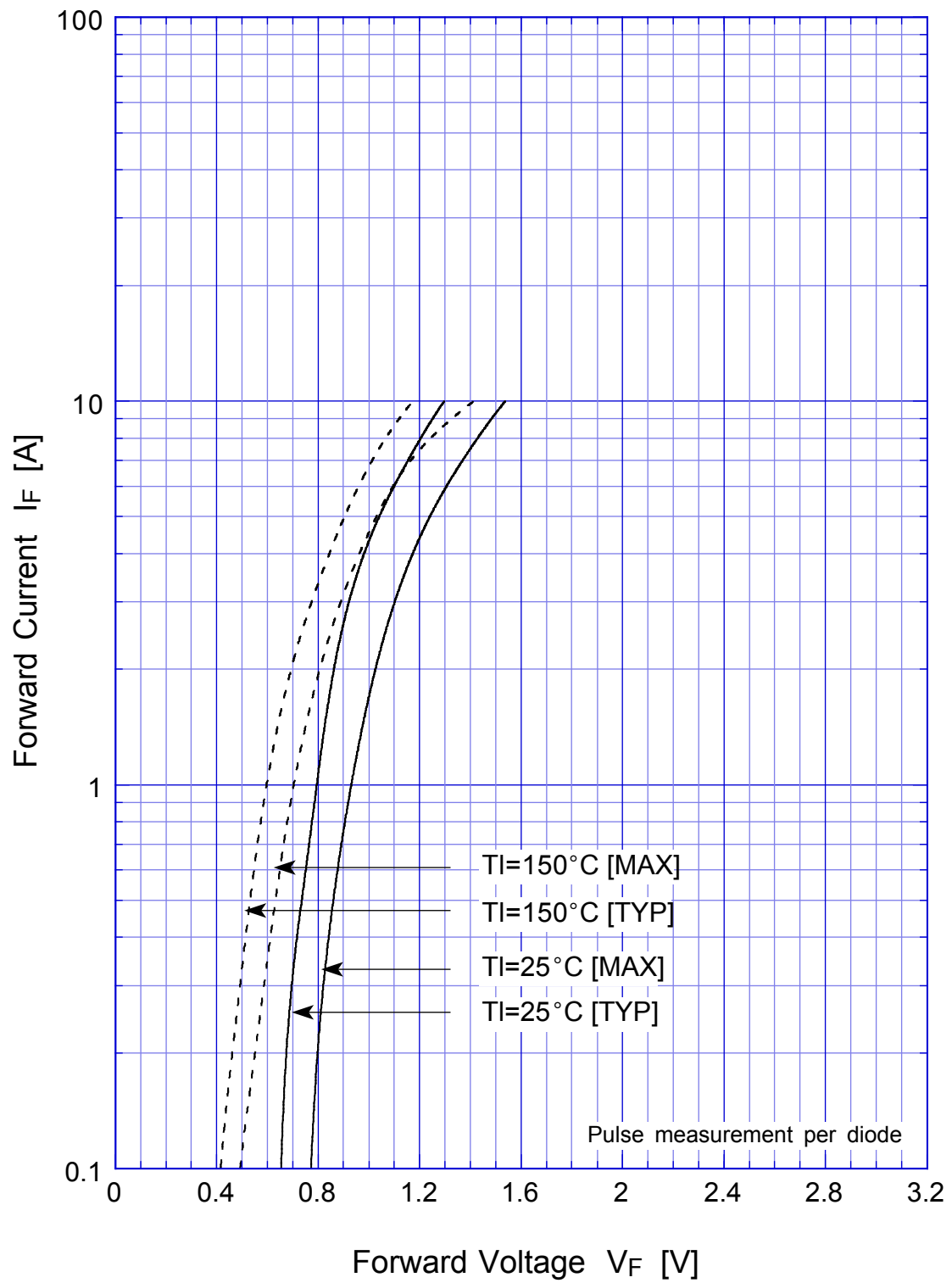

D2FL20U Forward Power Dissipation

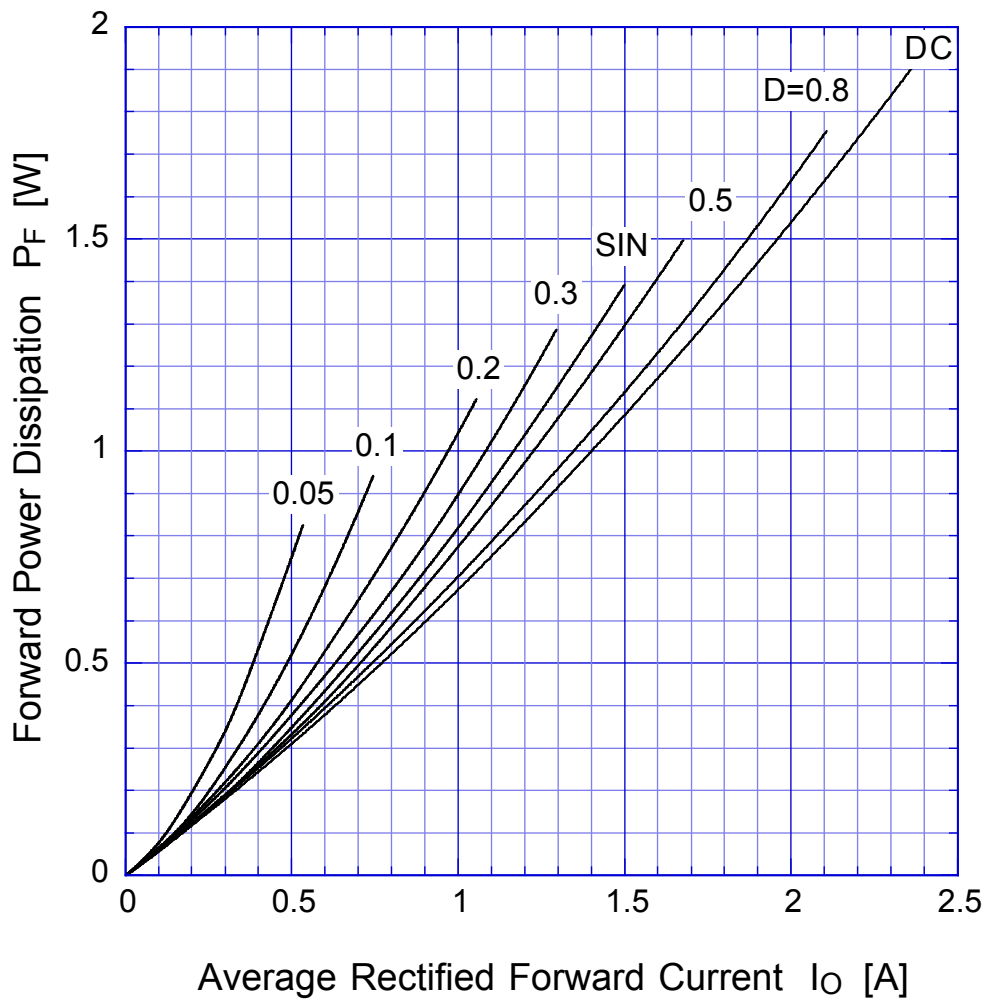

$T_j = T_{jmax}$



D2FL20U

Derating Curve

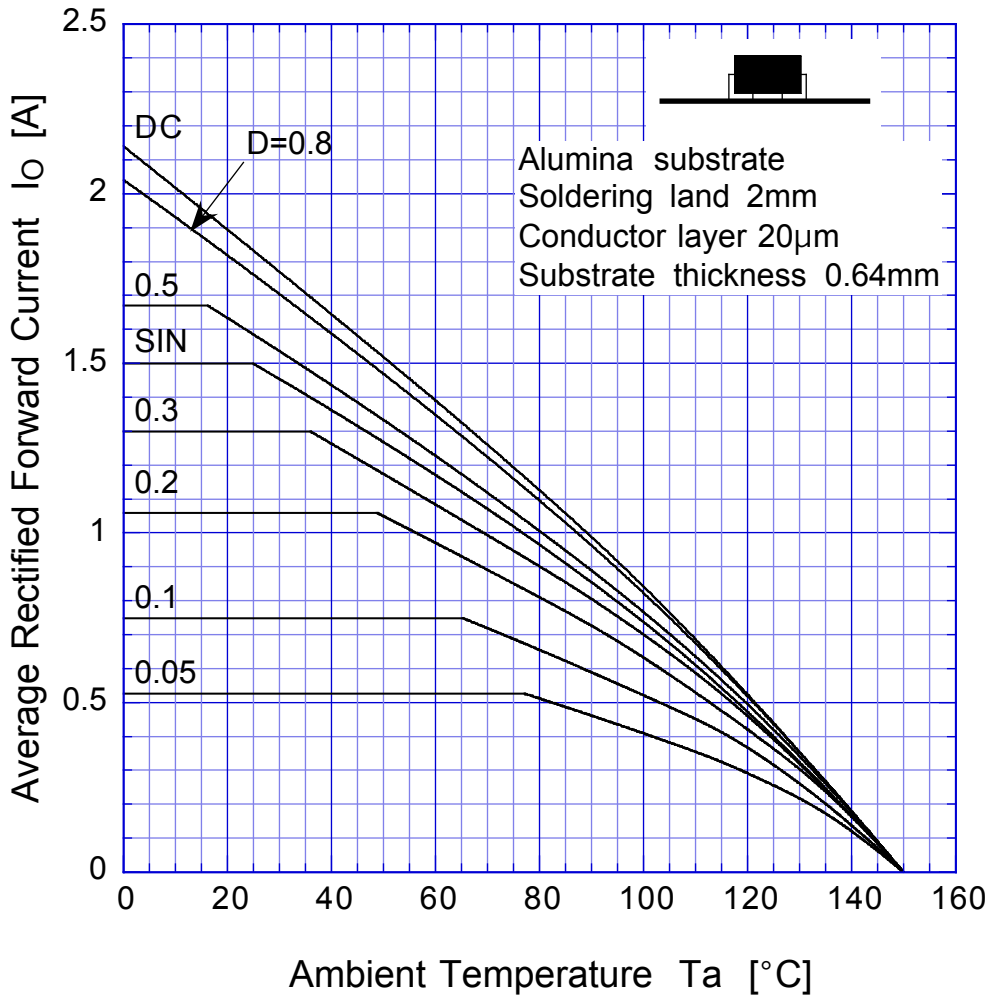

$$V_R = V_{RM}$$



D2FL20U

Derating Curve

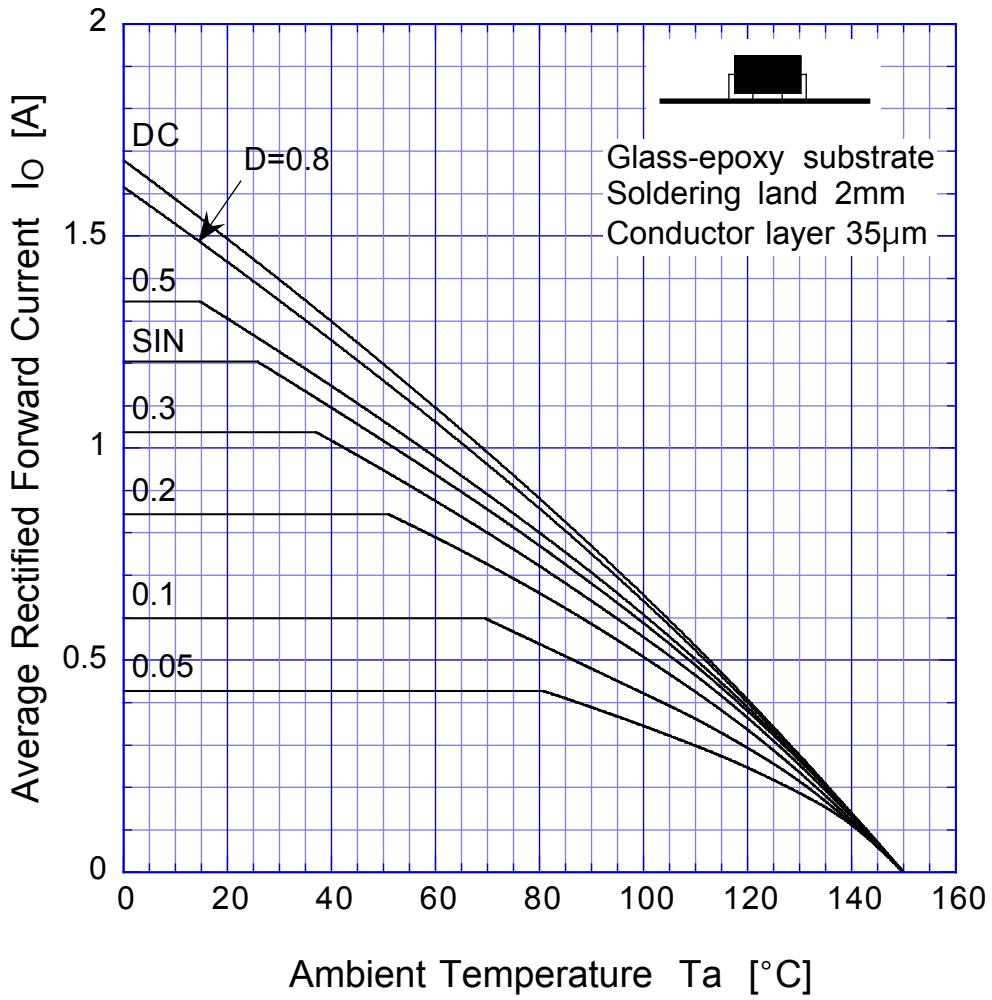

$$V_R = V_{RM}$$

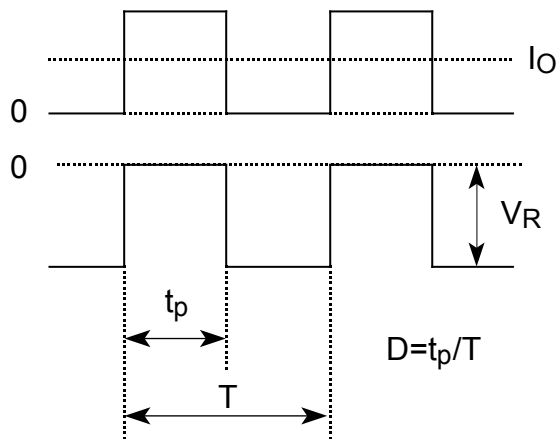

D2FL20U

Peak Surge Forward Capability

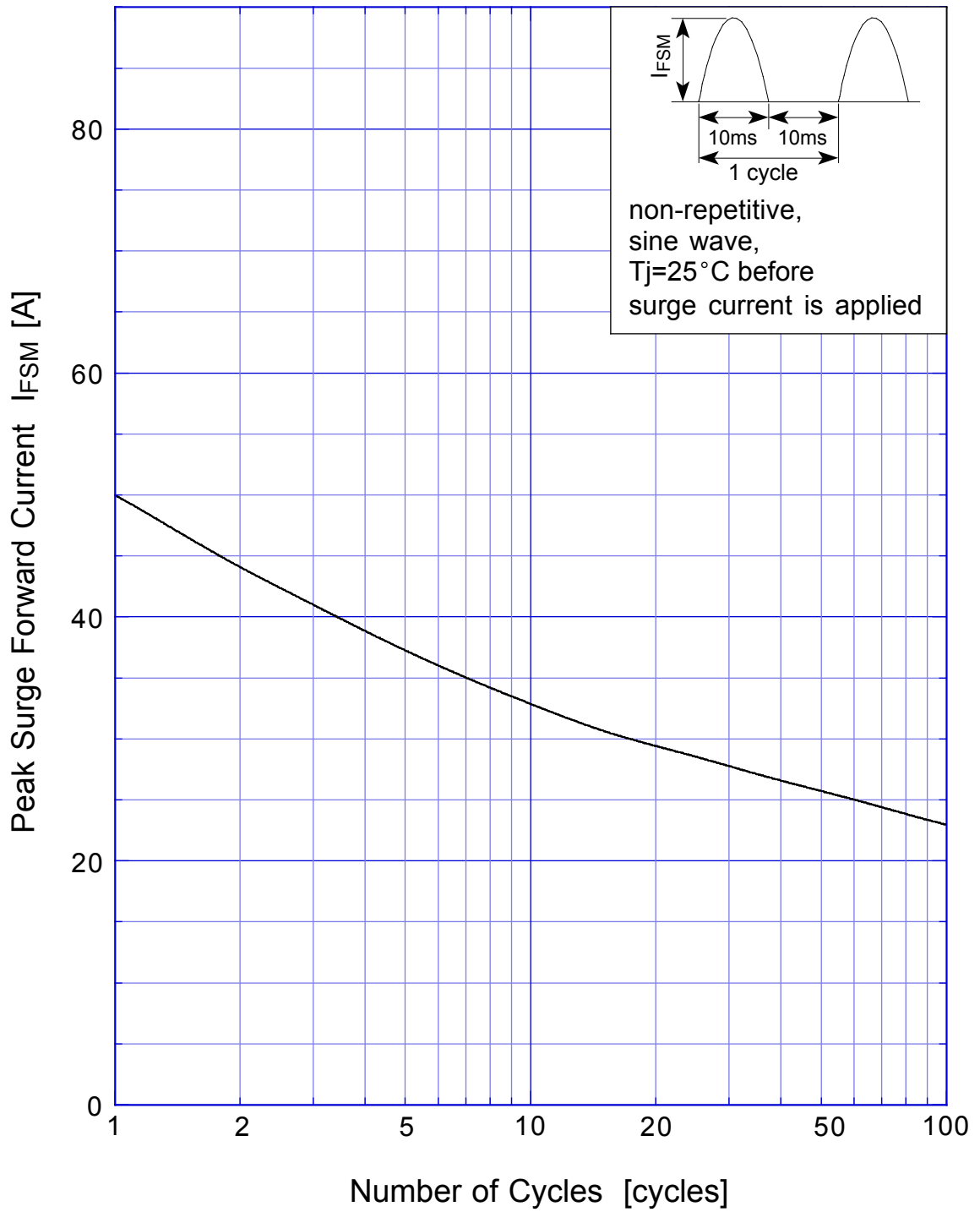

D2FL20U Junction Capacitance

