

# SHINDENGEN

## Super Fast Recovery Rectifiers

Single

# D2L20U

## 200V 1.5A

### FEATURES

- Low noise
- trr35ns
- Applicable to Automatic Insertion

### APPLICATION

- Switching power supply
- Free Wheel
- Home Appliances, Office Equipment
- Telecommunication, Factory Automation

### OUTLINE DIMENSIONS

Case : AX078

(Unit : mm)

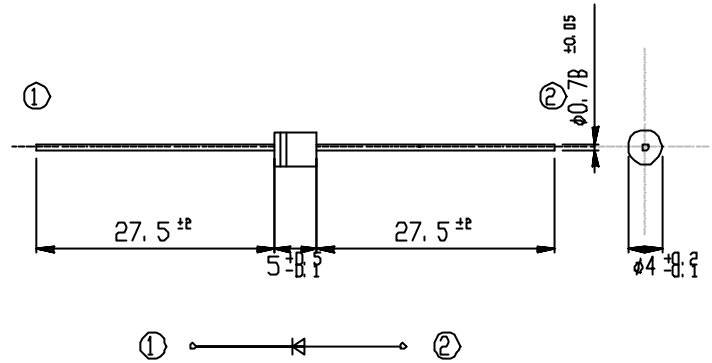

### RATINGS

Absolute Maximum Ratings (If not specified Tl=25 )

Item	Symbol	Conditions	Ratings	Unit
Storage Temperature	Tstg		-40 ~ 150	
Operating Junction Temperature	Tj		150	
Maximum Reverse Voltage	V <sub>RM</sub>		200	V
Average Rectified Forward Current	I <sub>O</sub>	50Hz sine wave, R-load, Tl=125	1.5	A
Peak Surge Forward Current	I <sub>FSM</sub>	50Hz sine wave, R-load, Ta=25	1.3	A
		50Hz sine wave, Non-repetitive 1 cycle peak value, Tj=25	40	A

Electrical Characteristics (If not specified Tl=25 )

Item	Symbol	Conditions	Ratings	Unit
Forward Voltage	V <sub>F</sub>	I <sub>F</sub> =1.5A, Pulse measurement	Max.0.98	V
Reverse Current	I <sub>R</sub>	V <sub>R</sub> =V <sub>RM</sub> , Pulse measurement	Max.10	μ A
Reverse Recovery Time	trr	I <sub>F</sub> =0.5A, I <sub>R</sub> =1A	Max.35	ns
Thermal Resistance	j-l	junction to lead	Max.17	/W
	j-a	junction to ambient	Max.105	

# D2L20U

## Forward Voltage

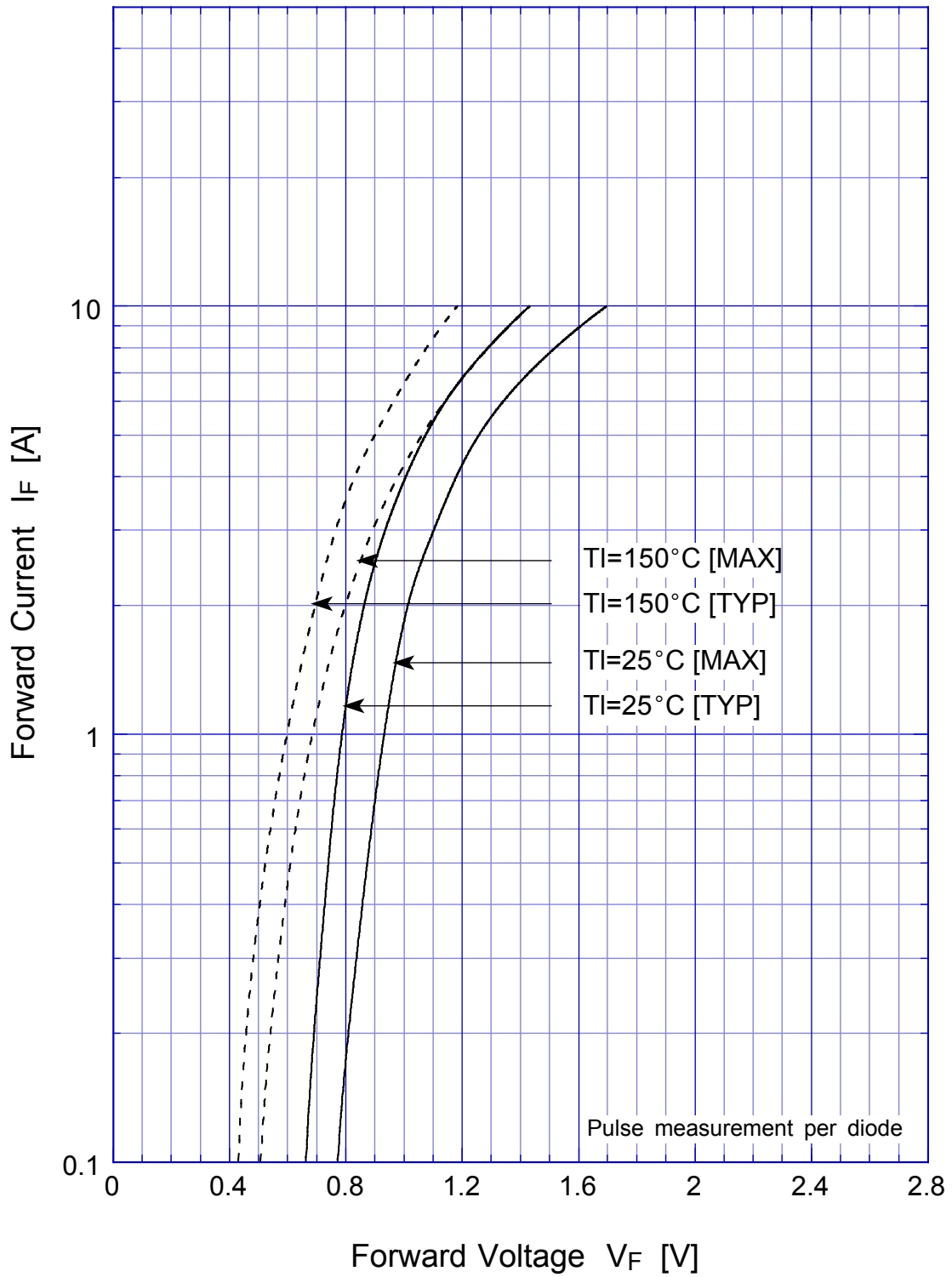

# D2L20U

## Forward Power Dissipation

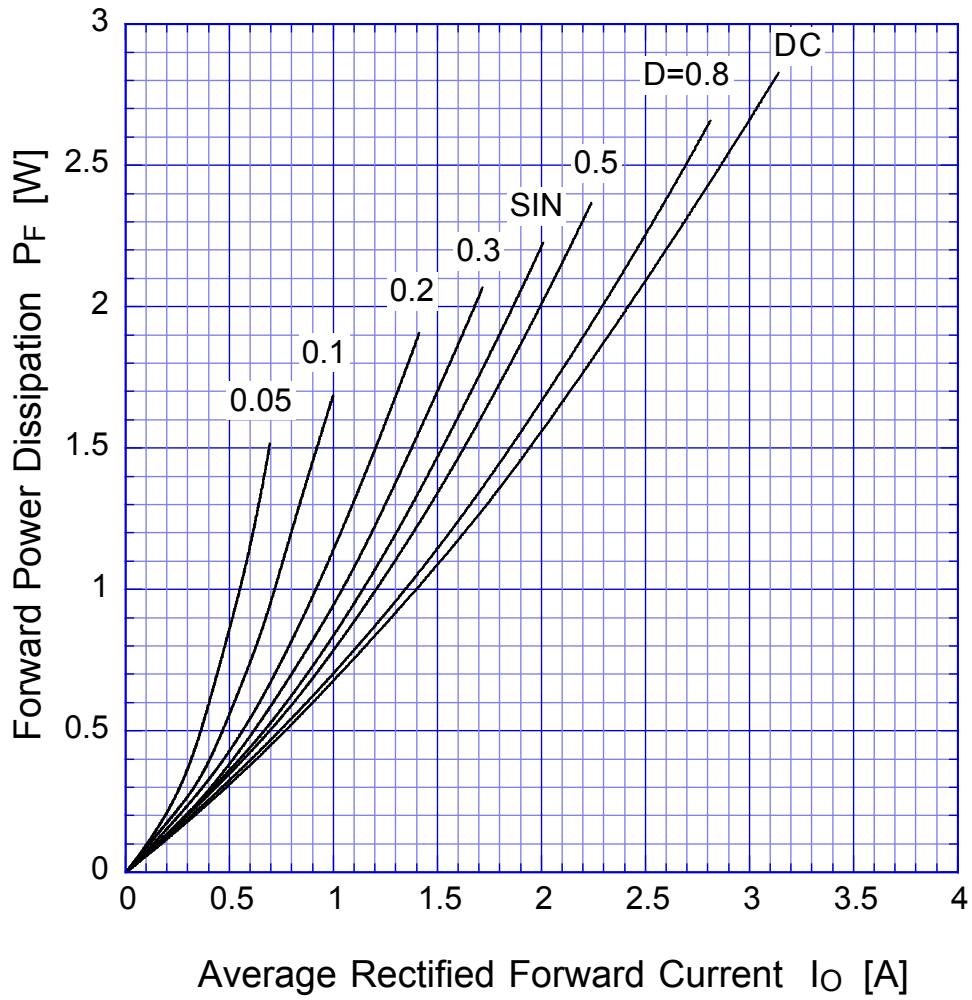

$T_j = T_{jmax}$

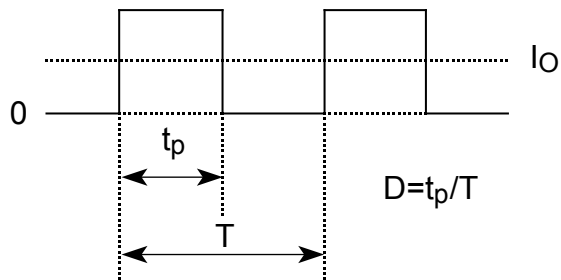

# D2L20U

# Derating Curve

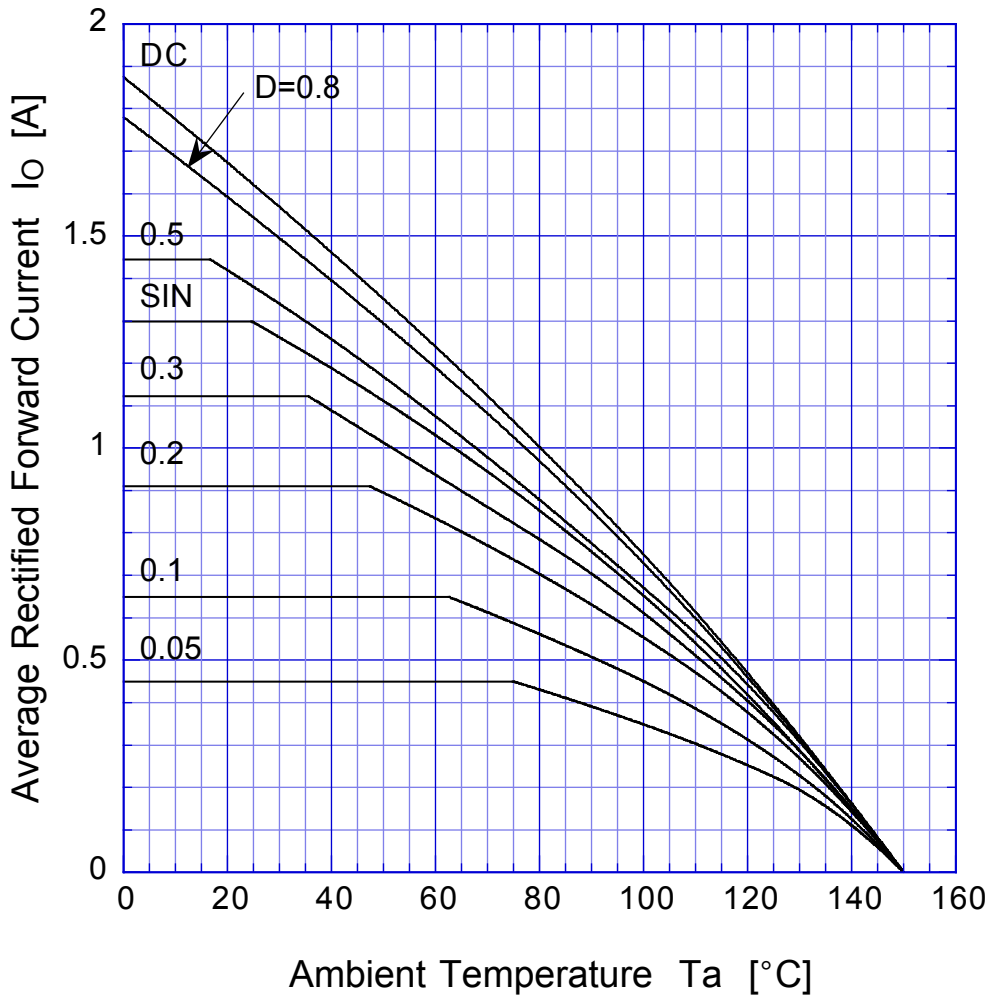

$$V_R = V_{RM}$$



# D2L20U

# Derating Curve

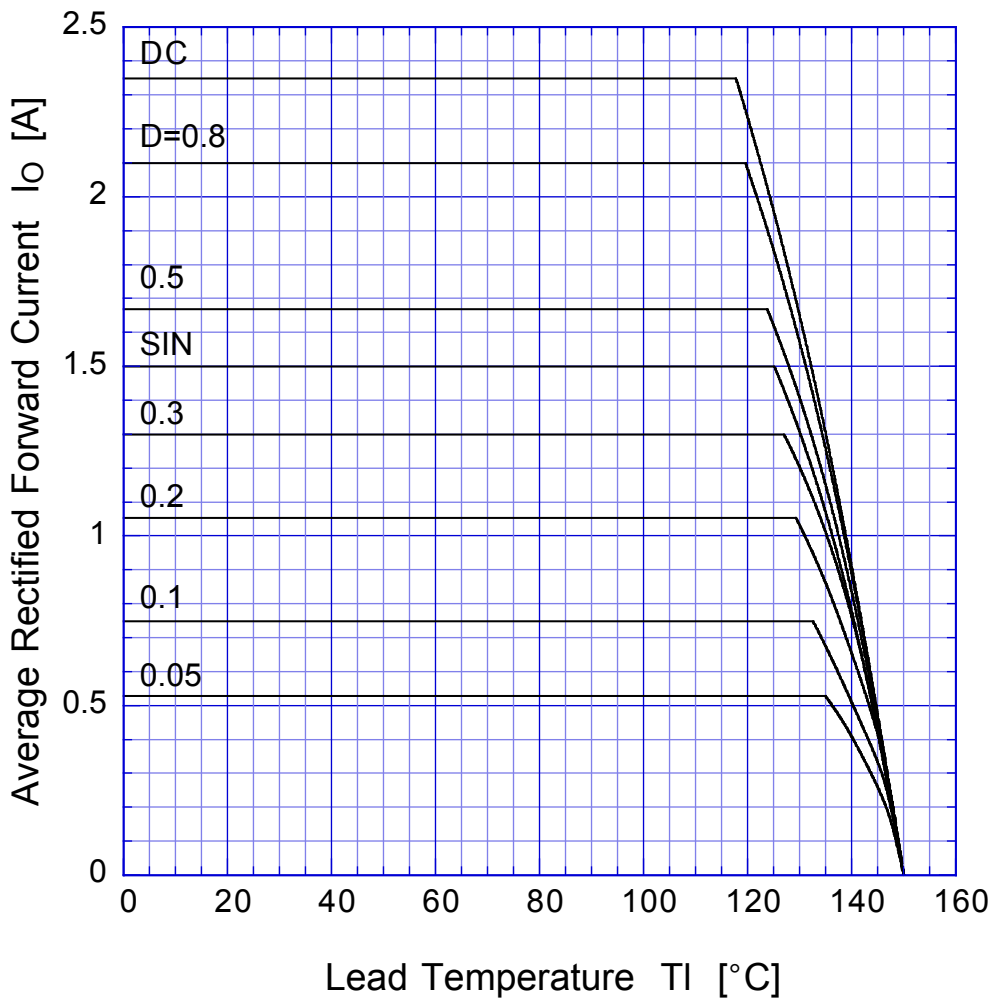

$$V_R = V_{RM}$$



# D2L20U

## Peak Surge Forward Capability

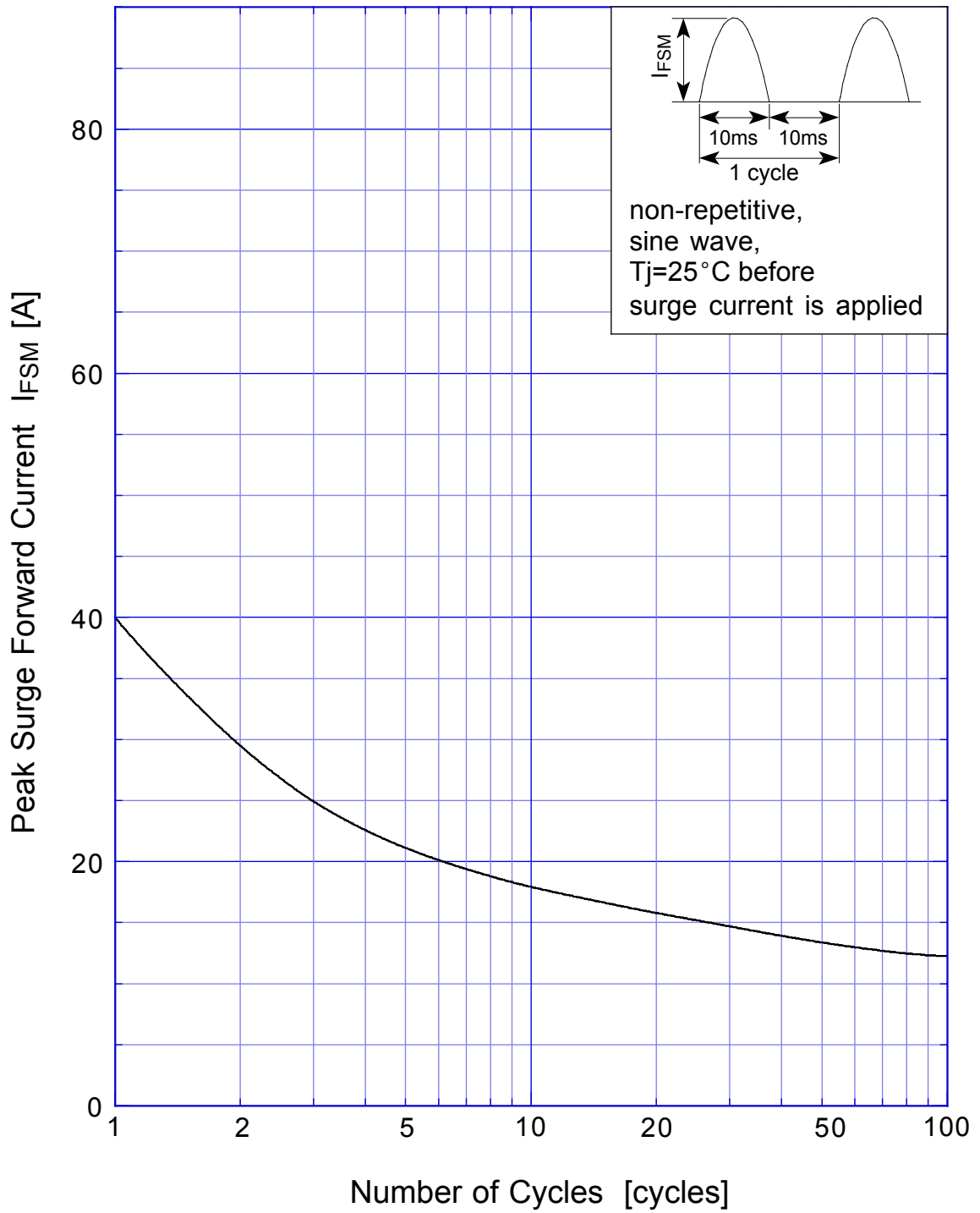

# D2L20U Junction Capacitance

