

SHINDENGEN

Super Fast Recovery Rectifiers

Single

D2L40

400V 2A

FEATURES

- Low noise
- trr50ns
- Applicable to Automatic Insertion

APPLICATION

- Switching power supply
- Free Wheel
- Home Appliances, Office Equipment
- Telecommunication, Factory Automation

OUTLINE DIMENSIONS

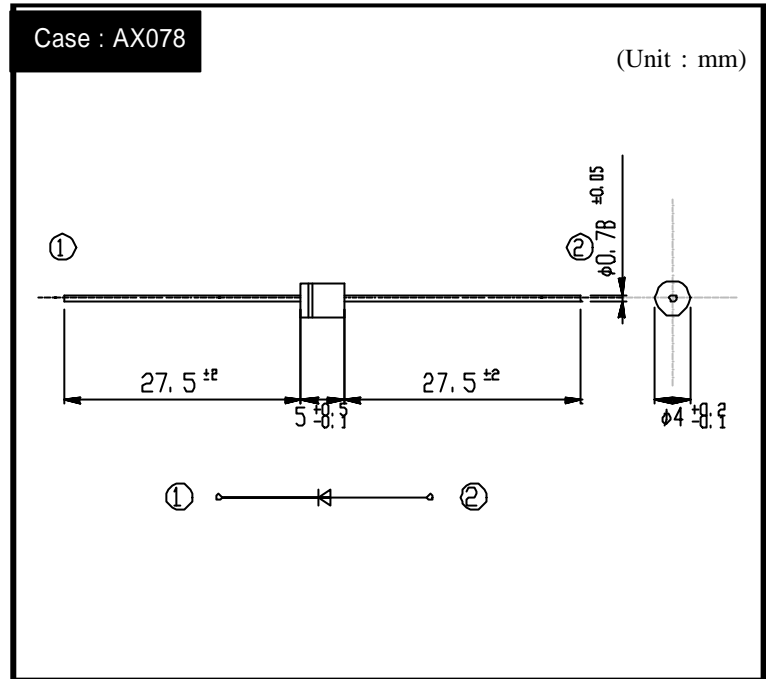

RATINGS

Absolute Maximum Ratings (If not specified Tl=25)

Item	Symbol	Conditions	Ratings	Unit
Storage Temperature	Tstg		-55 ~ 150	
Operating Junction Temperature	Tj		150	
Maximum Reverse Voltage	V _{RM}		400	V
Average Rectified Forward Current	I _O	50Hz sine wave, R-load, Tl=108	1.5	A
Peak Surge Forward Current	I _{FSM}	50Hz sine wave, Non-repetitive 1 cycle peak value, Tj=25	40	A

Electrical Characteristics (If not specified Tl=25)

Item	Symbol	Conditions	Ratings	Unit
Forward Voltage	V _F	I _F =1.1A, Pulse measurement	Max.1.3	V
Reverse Current	I _R	V _R =400V, Pulse measurement	Max.10	μA
Reverse Recovery Time	t _{rr}	I _F =0.5A, I _R =1A	Max.50	ns
Thermal Resistance	θ _{j-l}	junction to lead	Max.17	/W
	θ _{j-a}	junction to ambient	Max.105	

D2L40

Forward Voltage

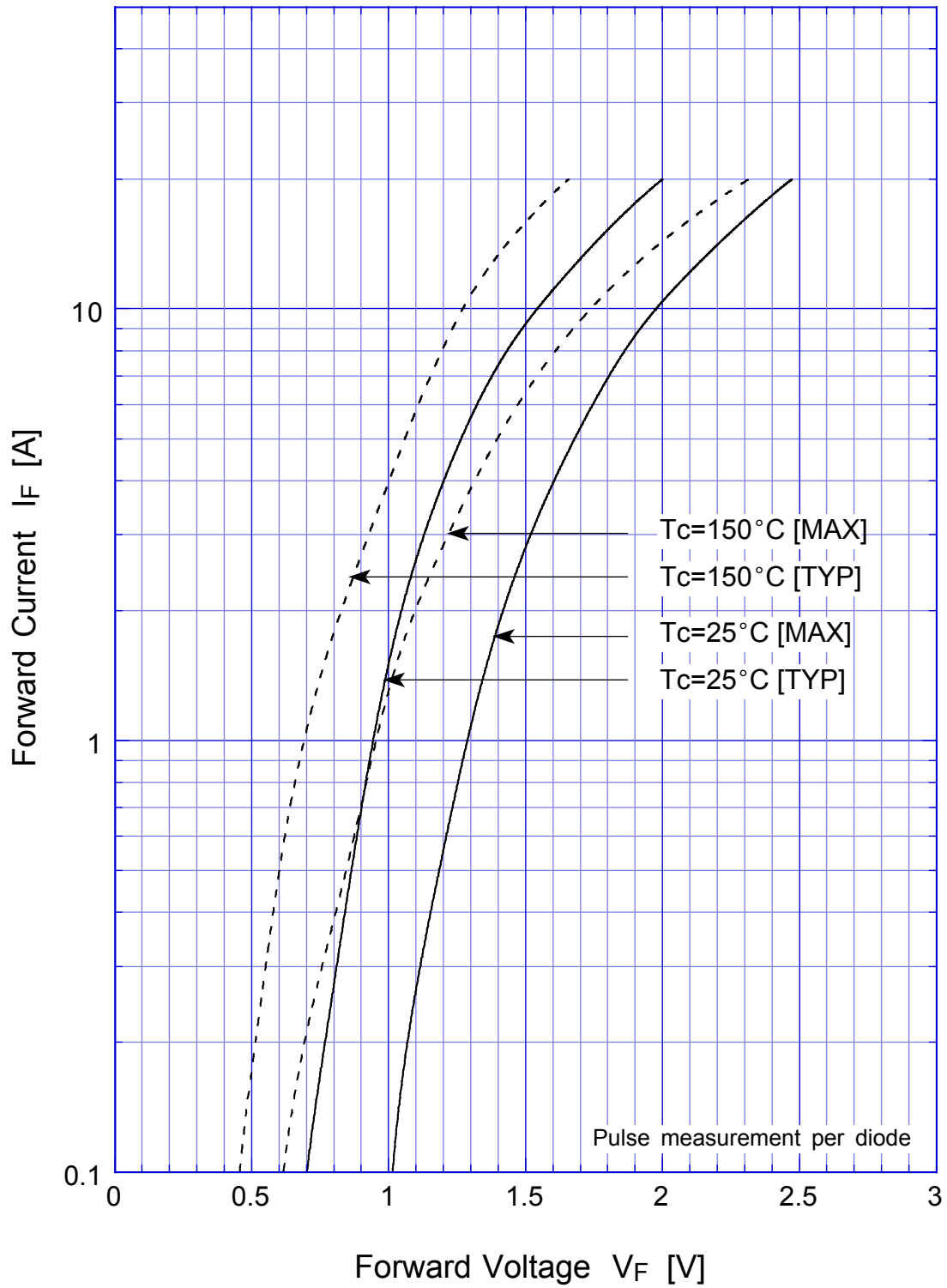

D2L40

Forward Power Dissipation

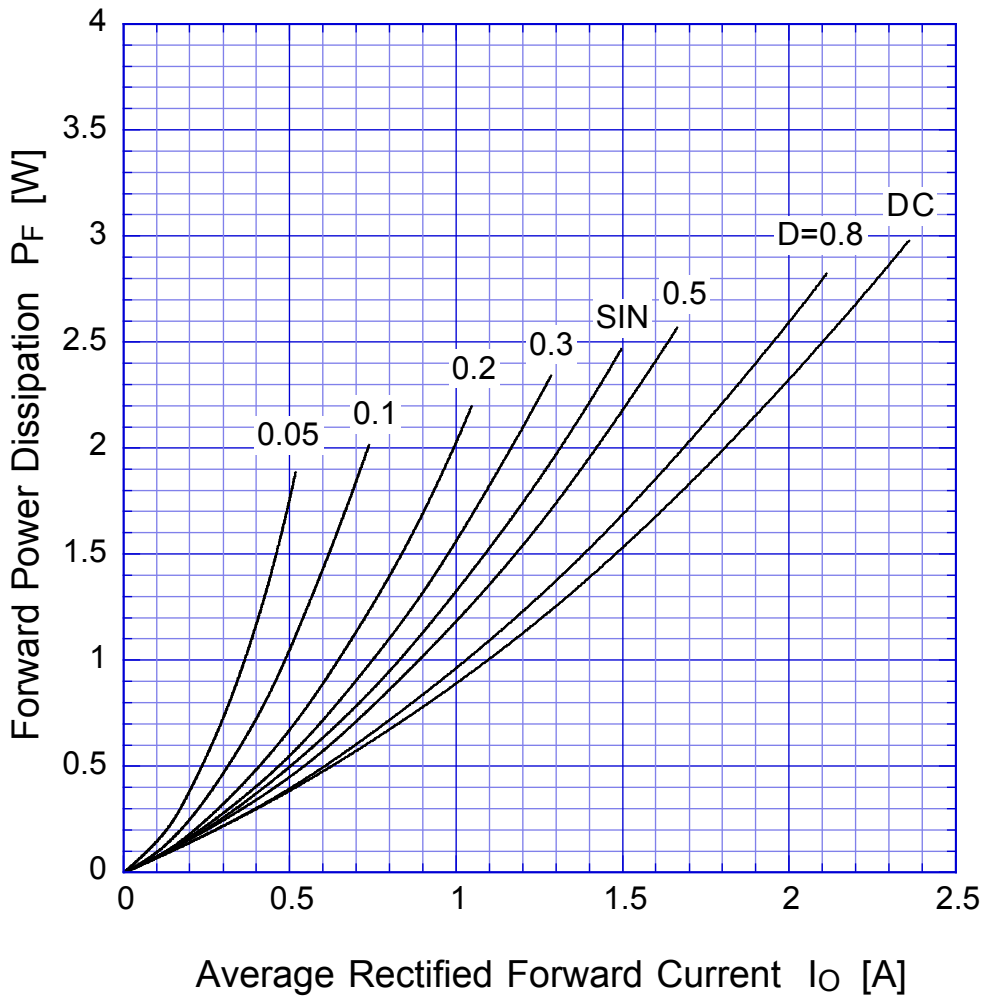

$T_j = 150^\circ\text{C}$

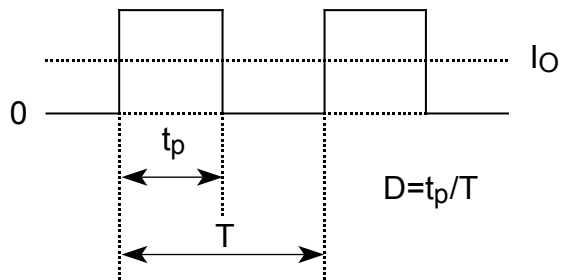

D2L40

Derating Curve

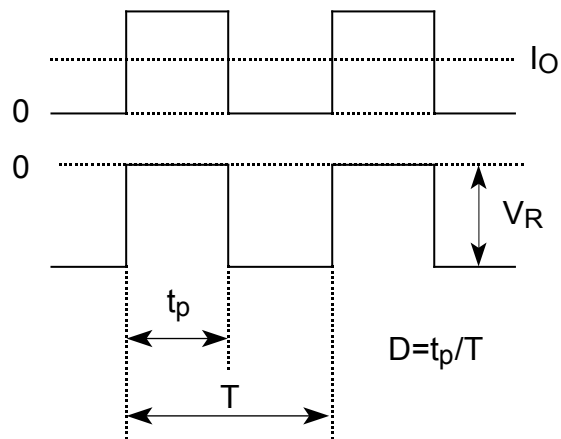
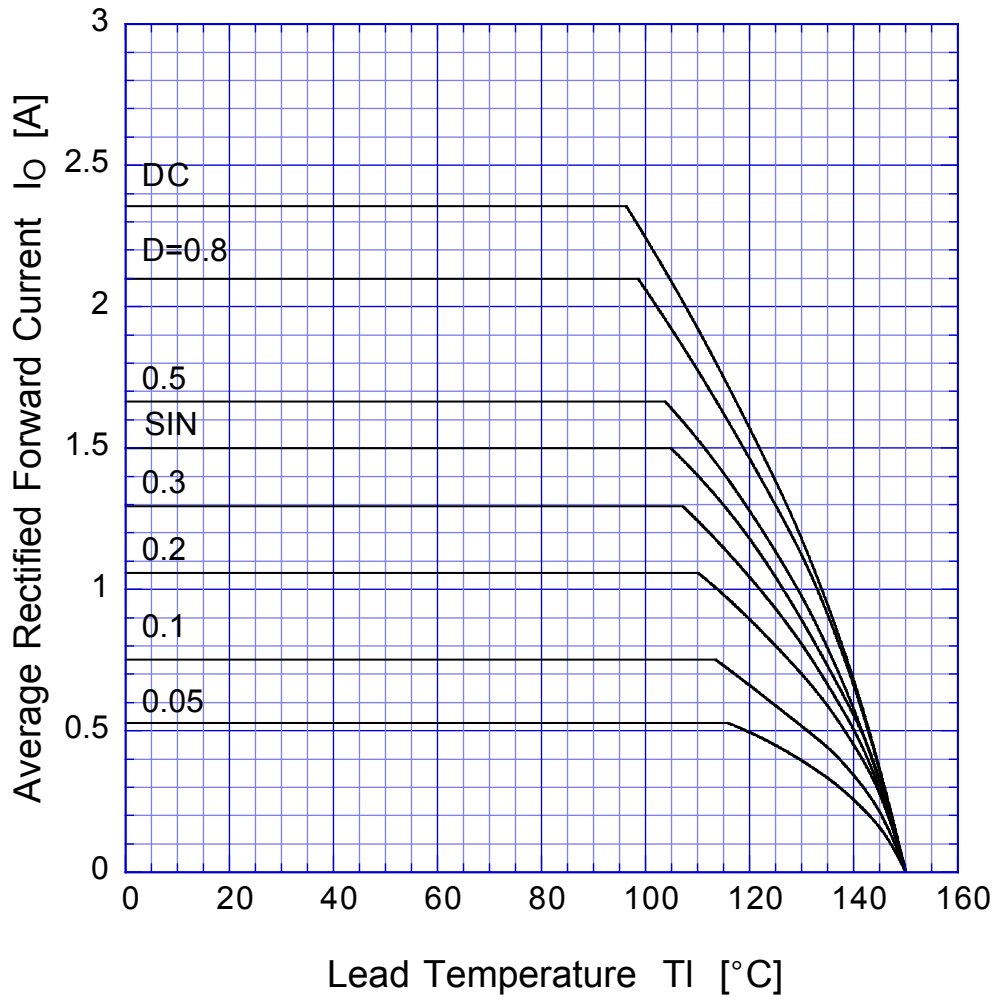

D2L40

Peak Surge Forward Capability

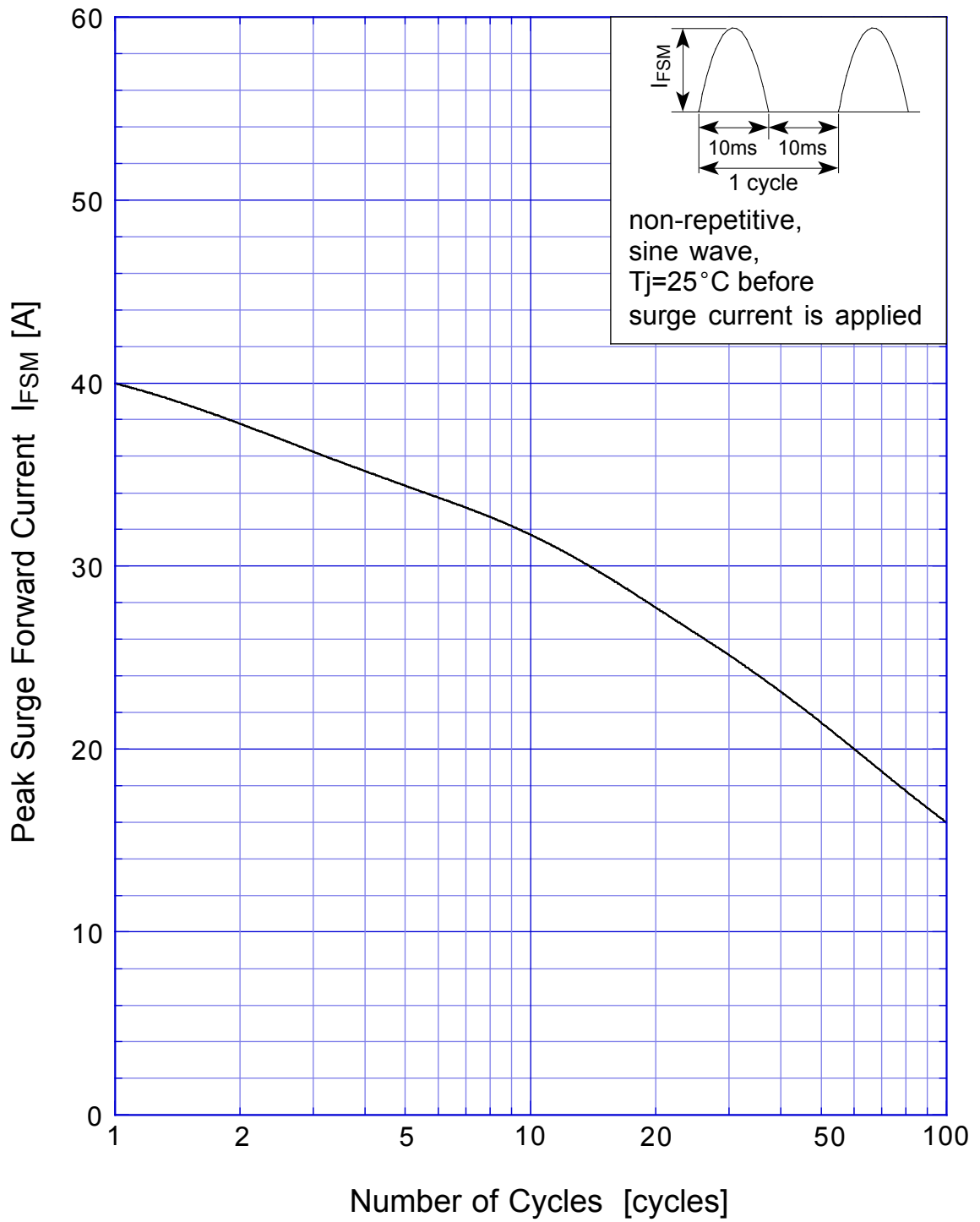

D2L40 Junction Capacitance

