

SHINDENGEN

Super Fast Recovery Rectifiers

Single

DE3L20U

200V 3A

FEATURES

SMT
Low noise
trr35ns

APPLICATION

Switching power supply
DC/DC converter
Free Wheel
Home Appliances, Office Equipment
Telecommunication, Factory Automation

OUTLINE DIMENSIONS

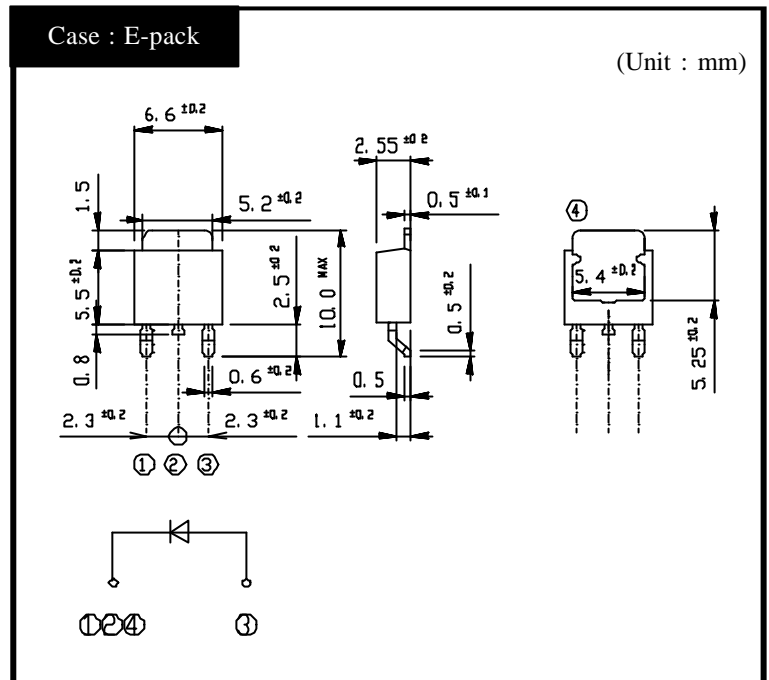

RATINGS

Absolute Maximum Ratings (If not specified $T_c=25$)

Item	Symbol	Conditions	Ratings	Unit
Storage Temperature	T_{stg}		-55 ~ 150	
Operating Junction Temperature	T_j		150	
Maximum Reverse Voltage	V_{RM}		200	V
Average Rectified Forward Current	I_O	50Hz sine wave, R-load, $T_c=113$	3	A
Peak Surge Forward Current	I_{FSM}	50Hz sine wave, Non-repetitive 1 cycle peak value, $T_j=25$	60	A

Electrical Characteristics (If not specified $T_c=25$)

Item	Symbol	Conditions	Ratings	Unit
Forward Voltage	V_F	$I_F=3A$, Pulse measurement	Max.0.98	V
Reverse Current	I_R	$V_R=V_{RM}$, Pulse measurement	Max.10	μA
Reverse Recovery Time	t_{rr}	$I_F=0.5A$, $I_R=1A$	Max.35	ns
Thermal Resistance	θ_c	junction to case	Max.12	/W

DE3L20U

Forward Voltage

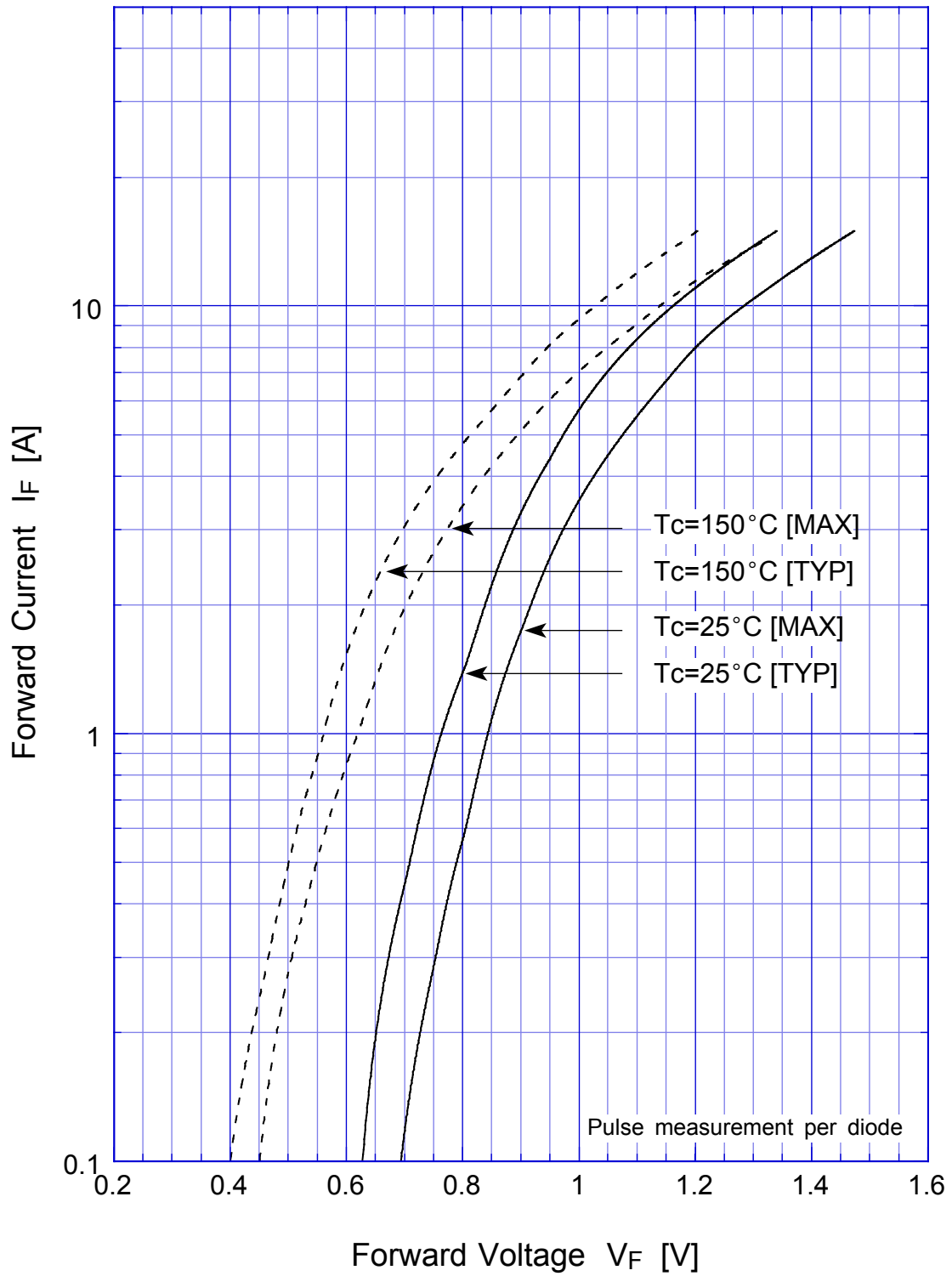

DE3L20U Forward Power Dissipation

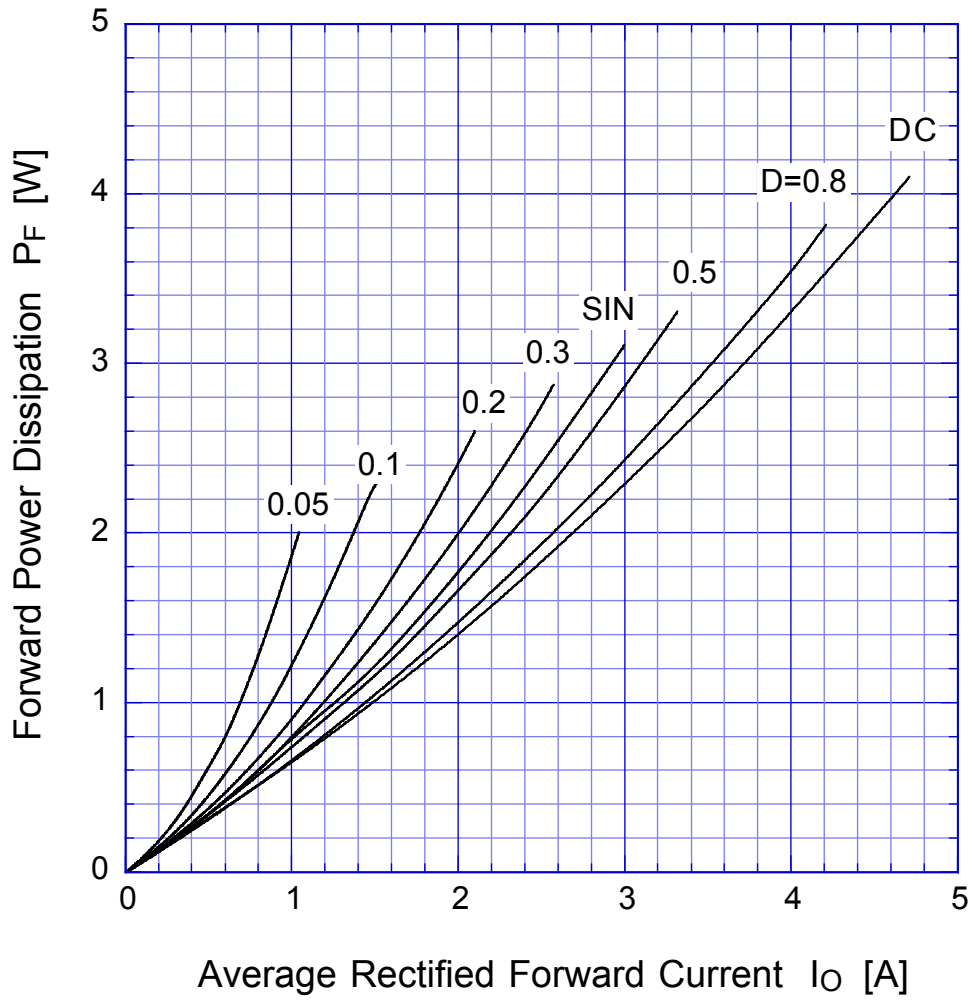

$T_j = 150^\circ\text{C}$

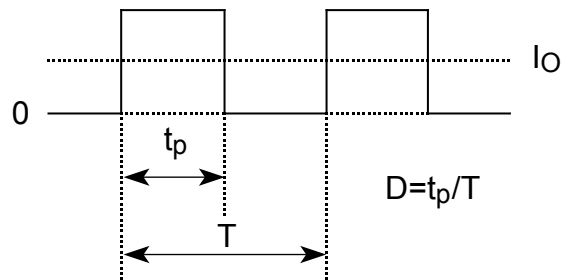

DE3L20U

Derating Curve

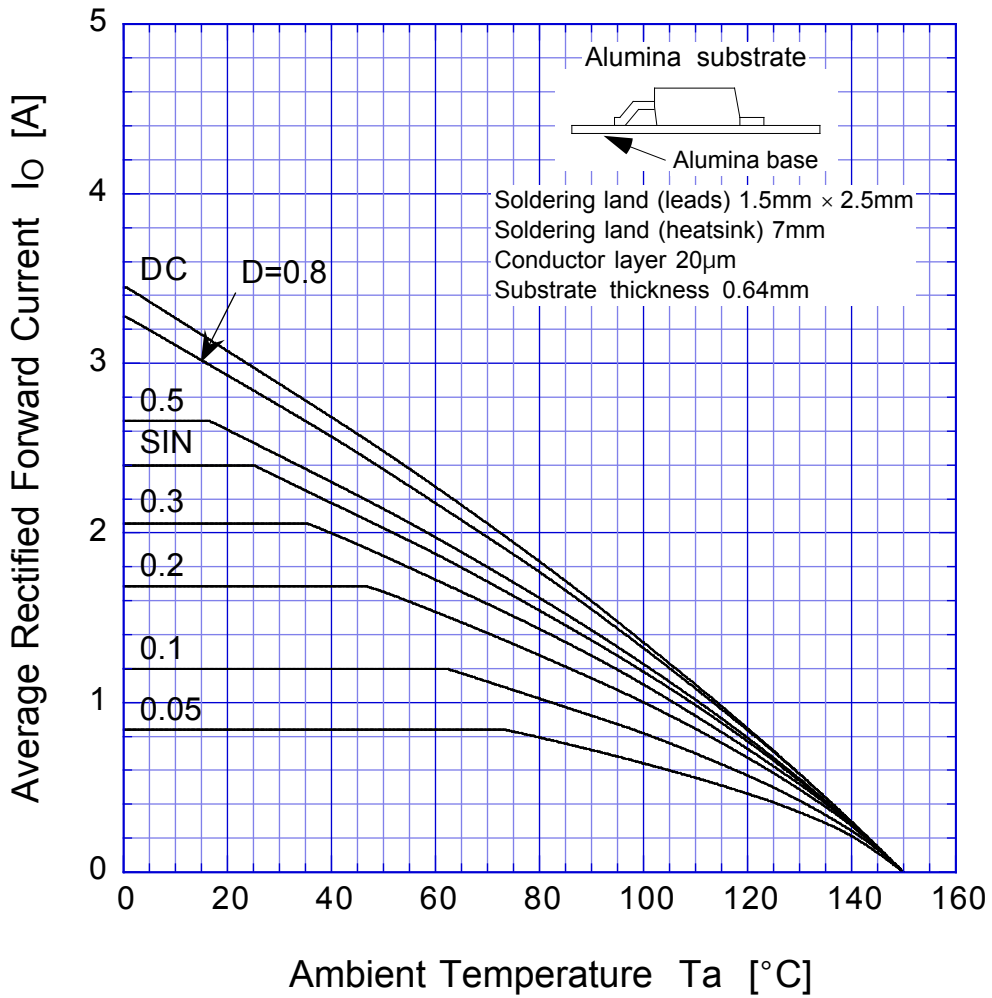

$V_R = 200V$

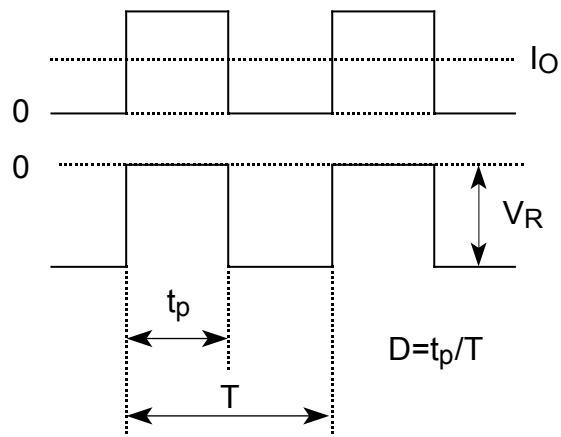

DE3L20U

Derating Curve

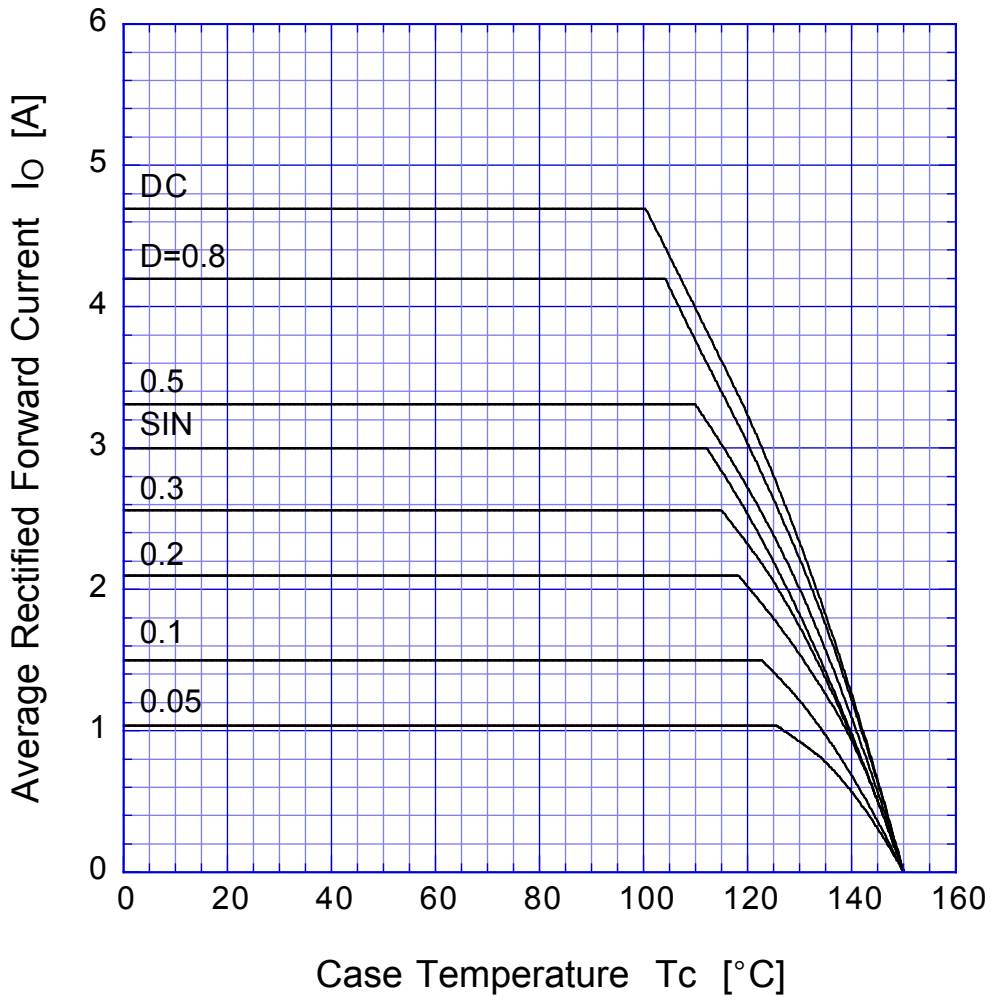

$V_R = 200V$



DE3L20U

Peak Surge Forward Capability

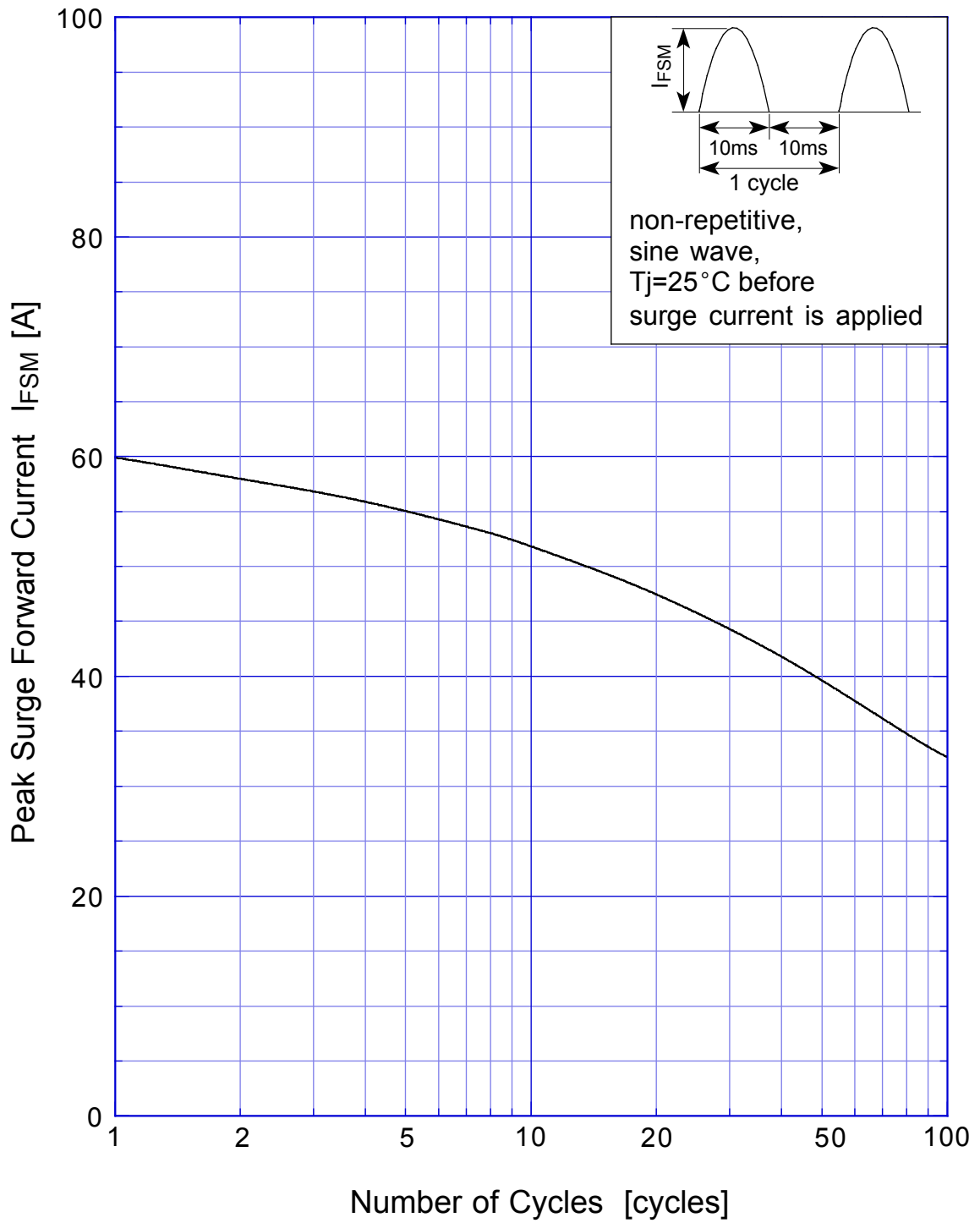

DE3L20U Junction Capacitance

