

SHINDENGEN

Super Fast Recovery Rectifiers

Single

SF5L60U

600V 5A

OUTLINE DIMENSIONS

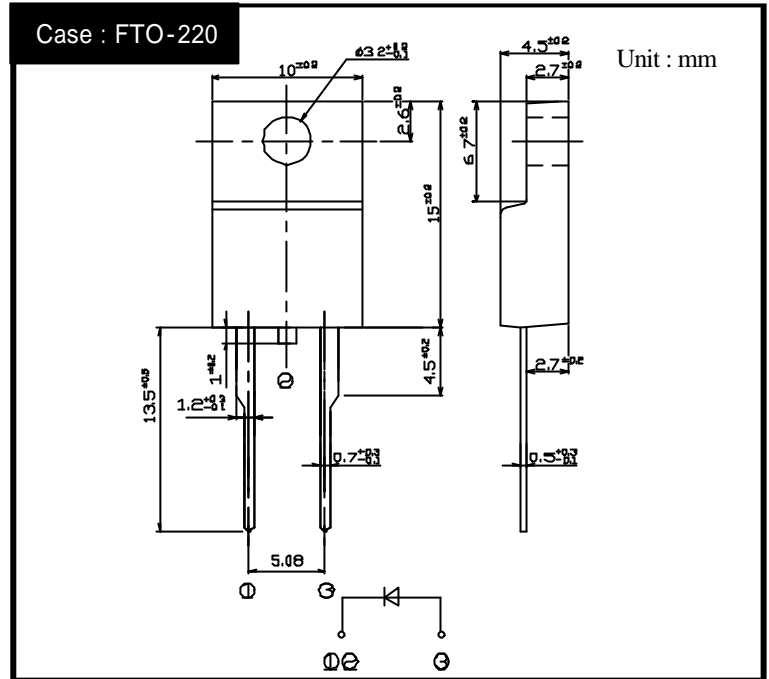

RATINGS

Absolute Maximum Ratings (If not specified $T_c=25$)

Item	Symbol	Conditions	Ratings	Unit
Storage Temperature	T_{stg}		-55 ~ 150	
Operating Junction Temperature	T_j		150	
Peak Reverse Voltage	V_{RM}		600	V
Average Rectified Forward Current	I_o	50Hz sine wave, resistance load, $T_c=96$	5	A
Peak Surge Forward Current	I_{FSM}	50Hz sine wave, Non-repetitive 1 cycle peak value, $T_j=25$	60	A
Dielectric Strength	V_{dis}	Terminals to case, AC 1 minute	2	kV
Mounting torque	TOR	(recommended torque)	0.5(0.3)	N·m

Electrical Characteristics (If not specified $T_c=25$)

Item	Symbol	Conditions	Ratings	Unit
Forward Voltage	V_F	$I_F=5A$, Pulse measurement	Max.3.0	V
Reverse Current	I_R	$V_R=V_{RM}$, Pulse measurement	Max.25	μA
Junction Capacitance	C_j	$f=1MHz$, $V_R=10V$	Typ.30	pF
Reverse Recovery Time	t_{rr}	$I_F=0.5A$, $I_R=1A$	Max.25	ns
Thermal Resistance	θ_c	junction to case	Max.3.6	/W

SF5L60U

Forward Voltage

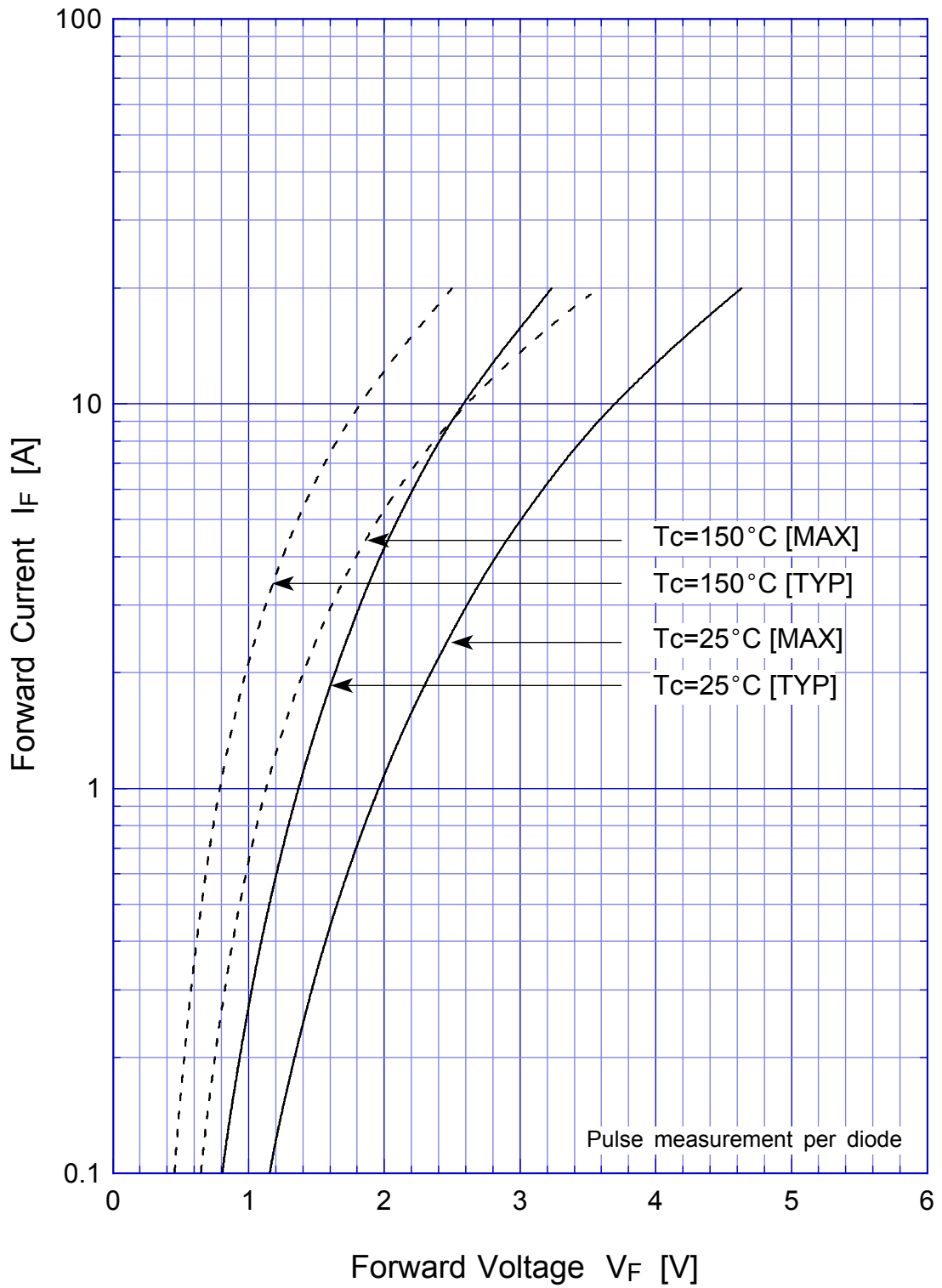

SF5L60U Forward Power Dissipation

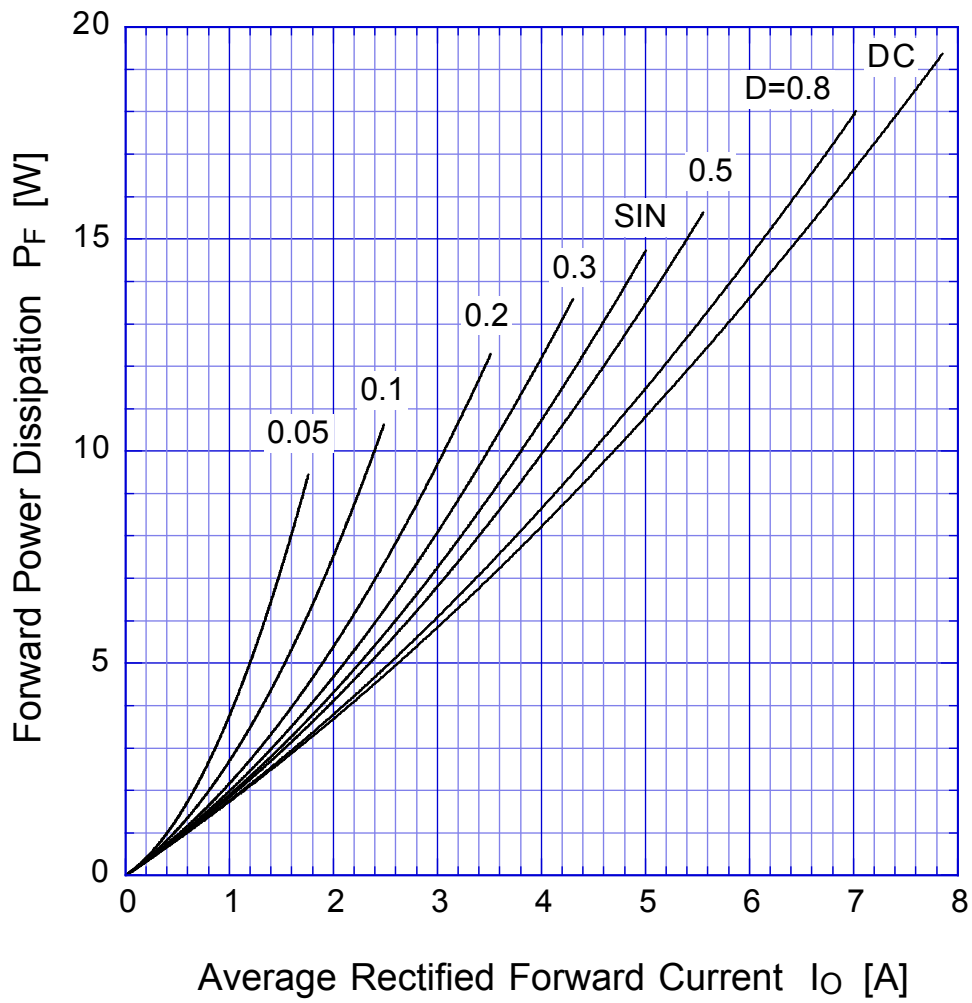

$T_j = 150^\circ\text{C}$

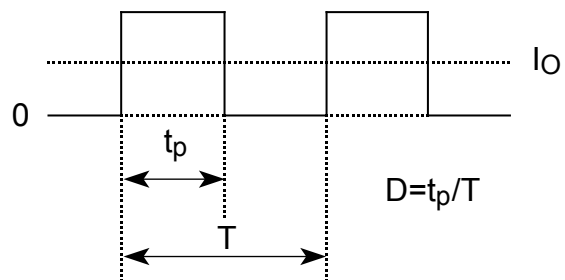

SF5L60U

Derating Curve

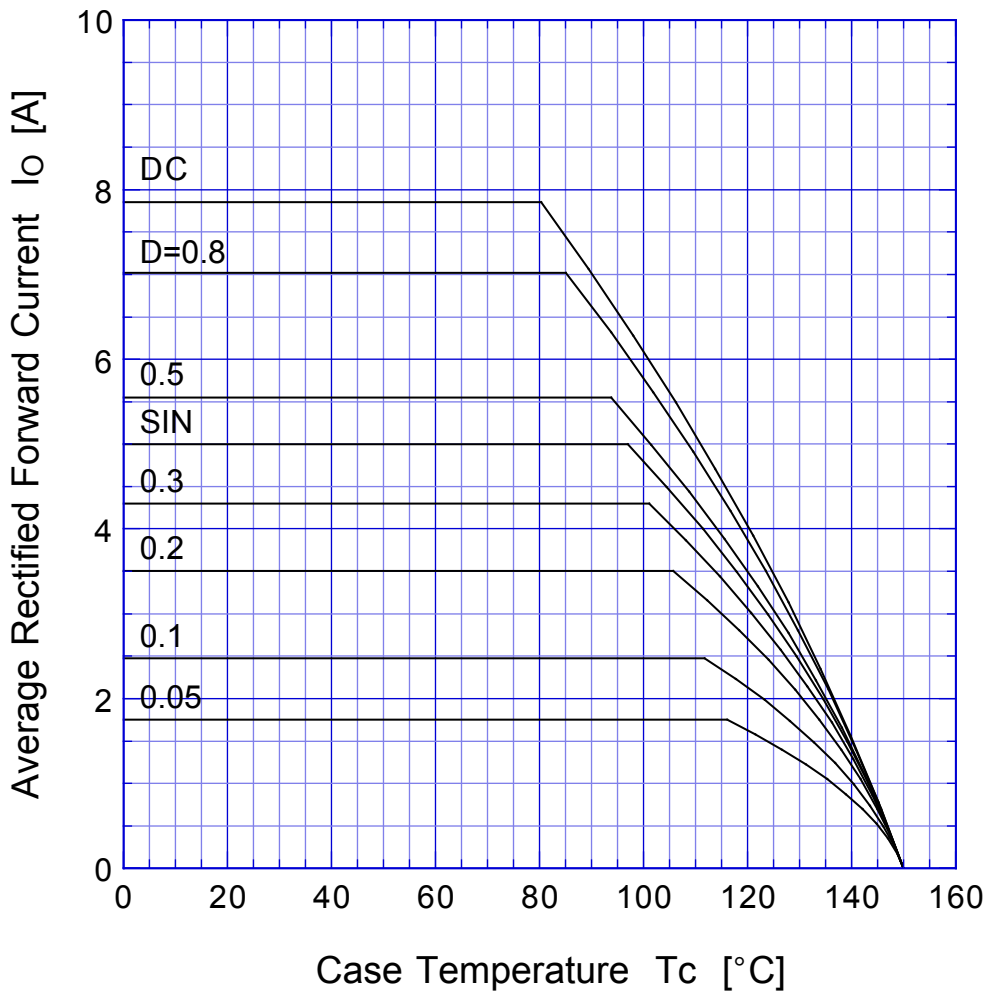

$$V_R = V_{RM}$$

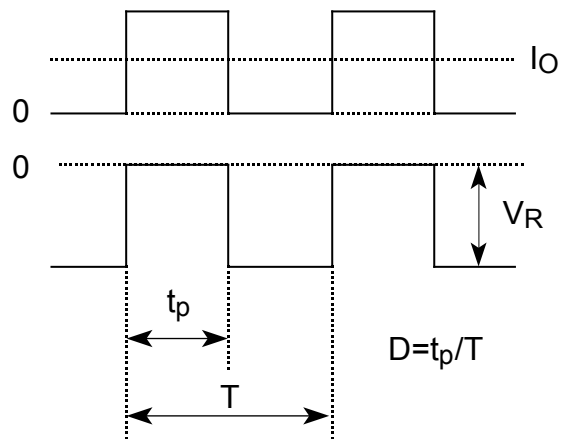

SF5L60U

Peak Surge Forward Capability

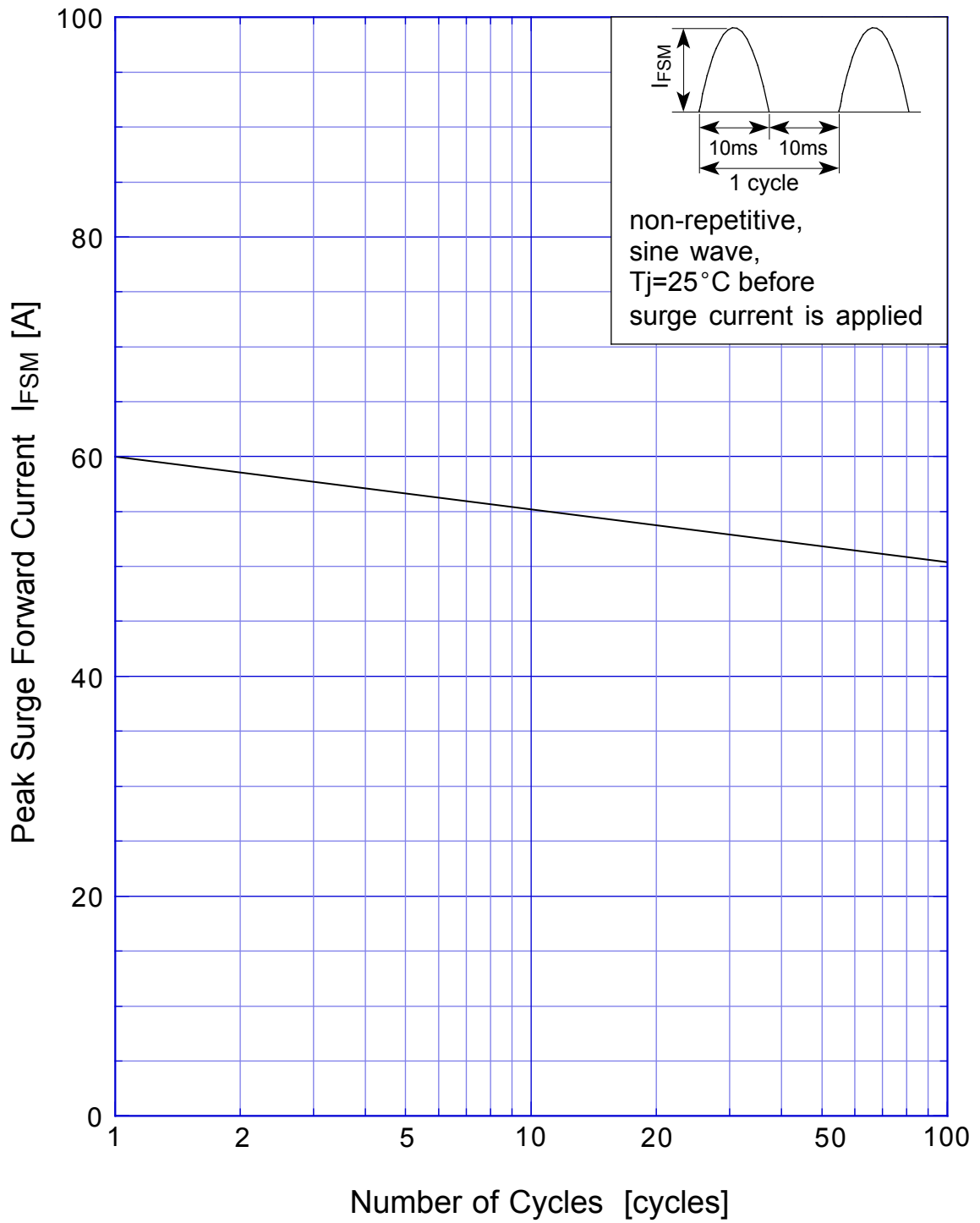

SF5L60U Junction Capacitance

