

SHINDENGEN

Schottky Rectifiers (SBD)

Dual

DF10SC4M

40V 10A

FEATURES

- SMT
- Tj150
- P_{RRSM} avalanche guaranteed
- High current capacity with Small Package

APPLICATION

- Switching power supply
- DC/DC converter
- Home Appliances, Office Equipment
- Telecommunication

OUTLINE DIMENSIONS

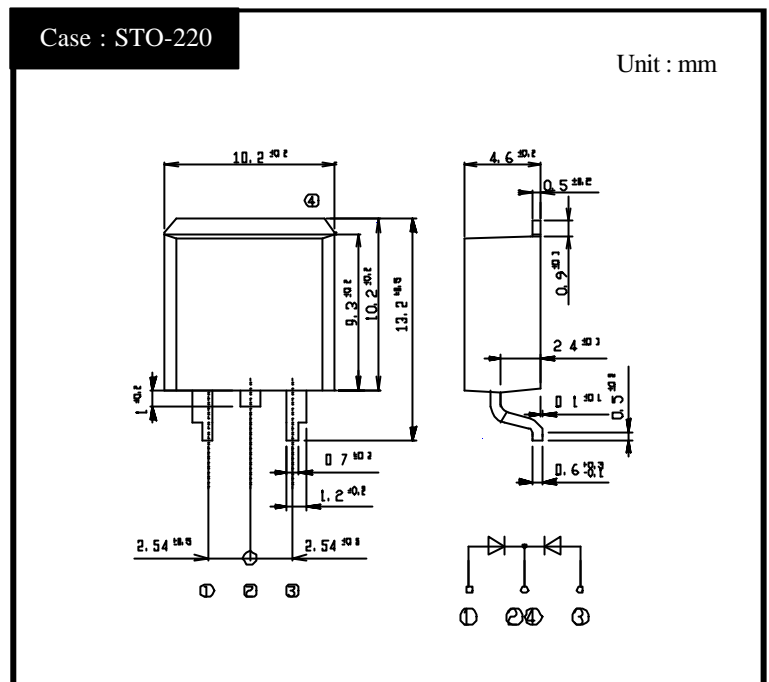

RATINGS

Absolute Maximum Ratings (If not specified Tc=25)

Item	Symbol	Conditions	Ratings	Unit
Storage Temperature	Tstg		-40 ~ 150	
Operating Junction Temperature	Tj		150	
Maximum Reverse Voltage	V _{RM}		40	V
Repetitive Peak Surge Reverse Voltage	V _{RRSM}	Pulse width 0.5ms, duty 1/40	45	V
Average Rectified Forward Current	I _o	50Hz sine wave, R-load, Rating for each diode I _o /2, With heatsink, Tc=125	10	A
		50Hz sine wave, R-load, Rating for each diode I _o /2, On Al-Cu substrate, Ta=33	6.8	
Peak Surge Forward Current	I _{FSM}	50Hz sine wave, Non-repetitive 1 cycle peak value, Tj=125	100	A
Repetitive Peak Surge Reverse Power	P _{RRSM}	Pulse width 10 μs, Rating of per diode, Tj=25	330	W

Electrical Characteristics (If not specified Tc=25)

Item	Symbol	Conditions	Ratings	Unit
Forward Voltage	V _F	I _F =5A, Pulse measurement, Rating of per diode	Max.0.55	V
Reverse Current	I _R	V _R =V _{RM} , Pulse measurement, Rating of per diode	Max.3.5	mA
Junction Capacitance	C _j	f=1MHz, V _R =10V, Rating of per diode	Typ.180	pF
Thermal Resistance	jc	junction to case	Max.3	/W
	ja	junction to ambient, On Al-Cu substrate	Max.25	

DF10SC4M Forward Voltage

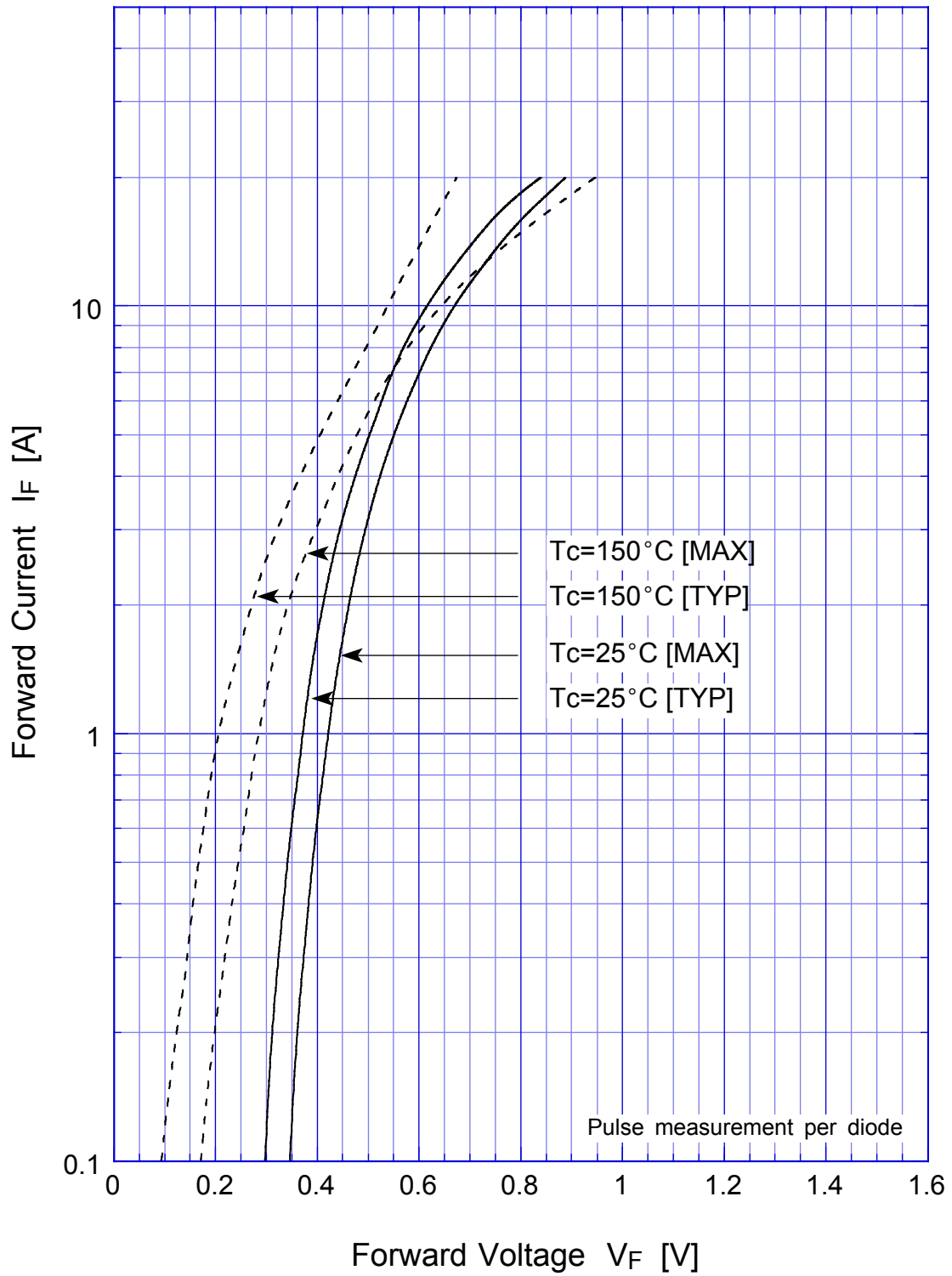

DF10SC4M Junction Capacitance

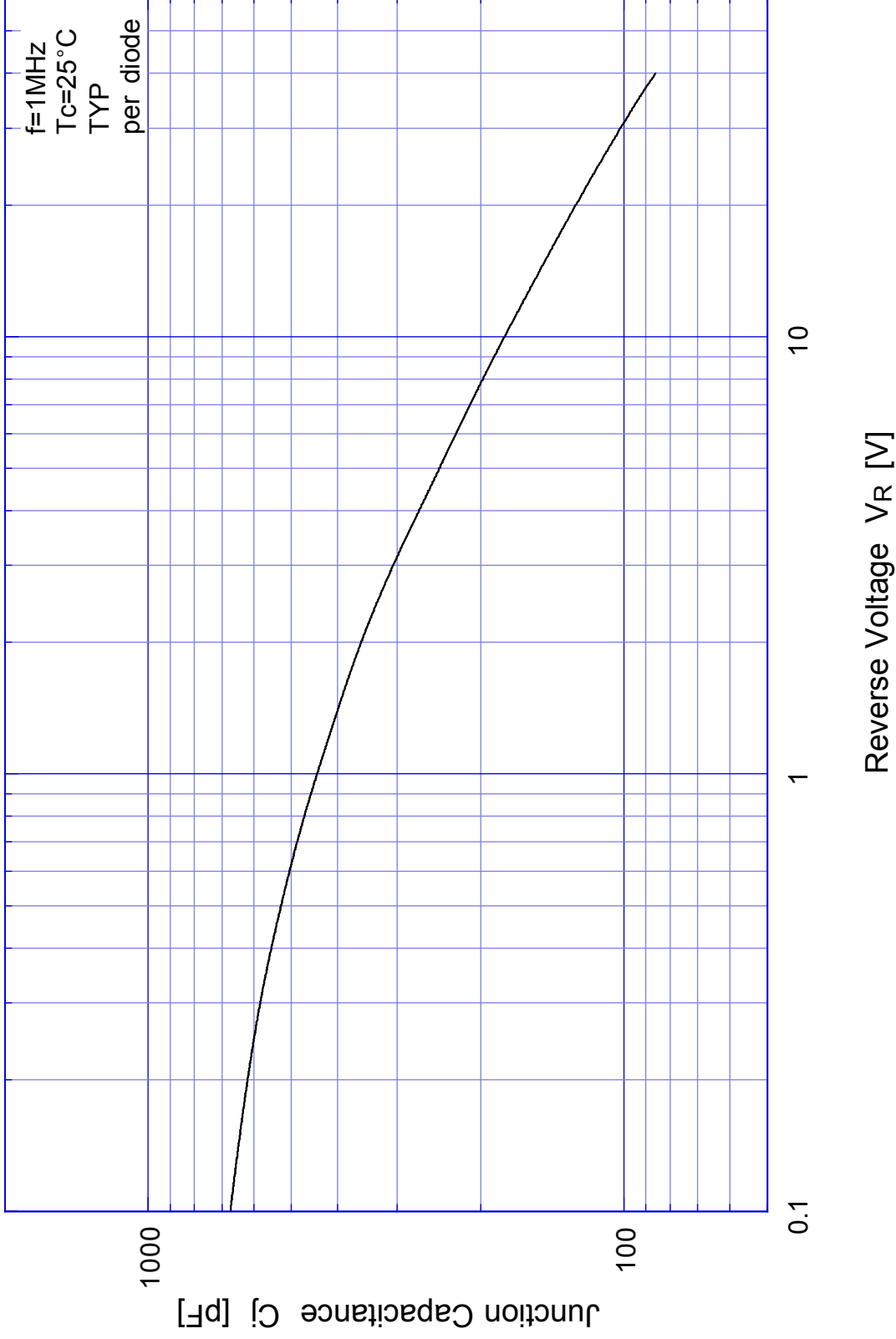

DF10SC4M Reverse Current

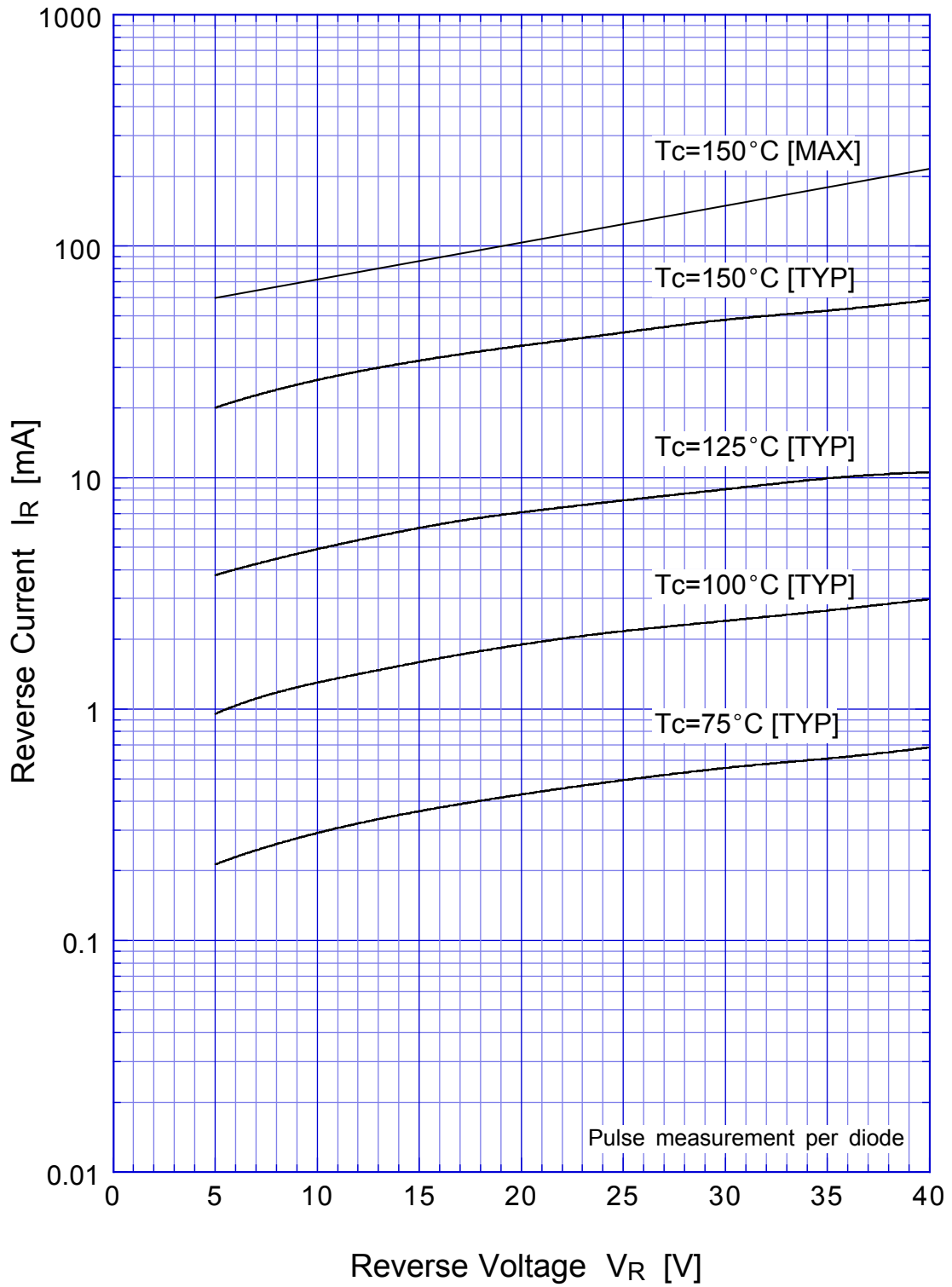

DF10SC4M Reverse Power Dissipation

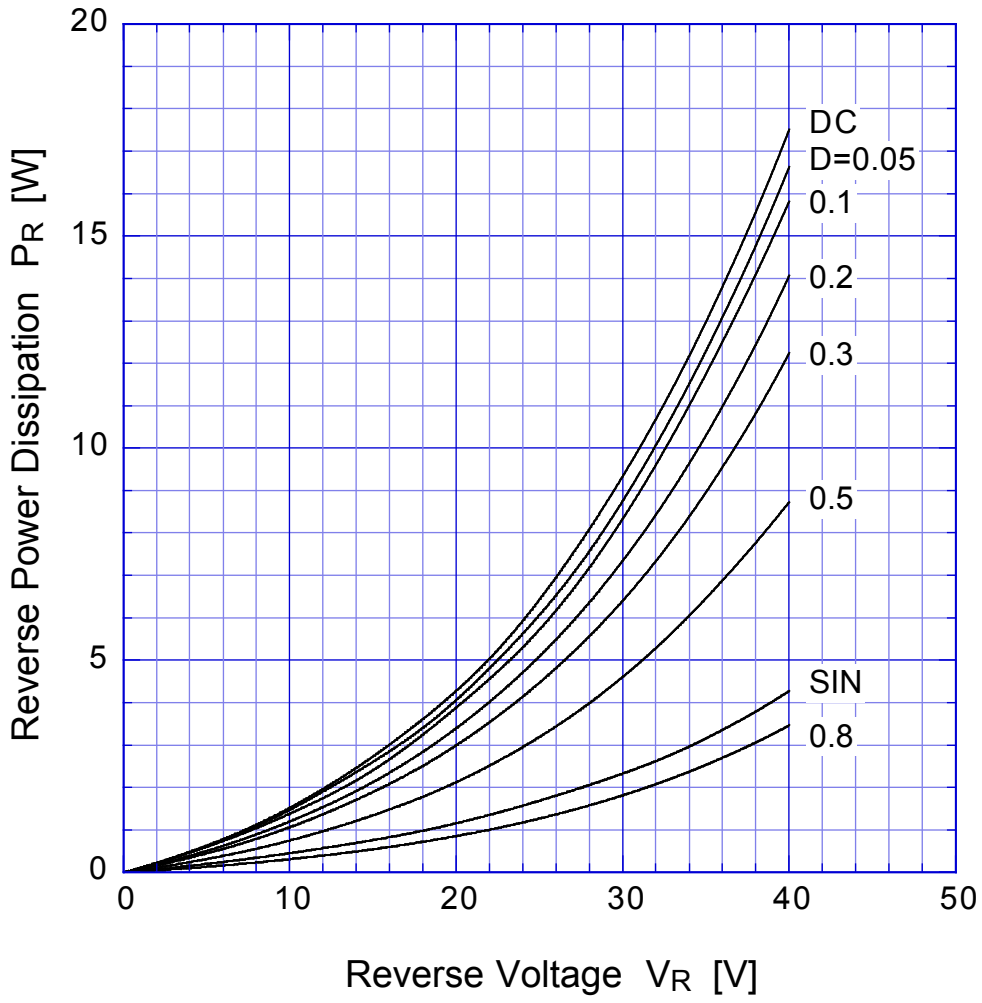

$T_j = 150^\circ\text{C}$

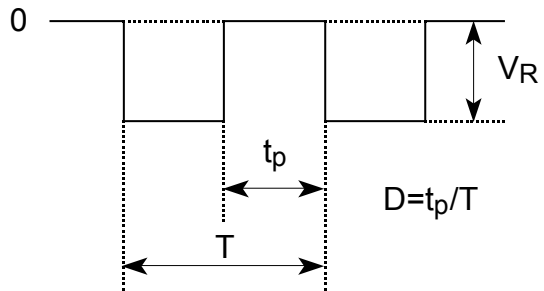

DF10SC4M Forward Power Dissipation

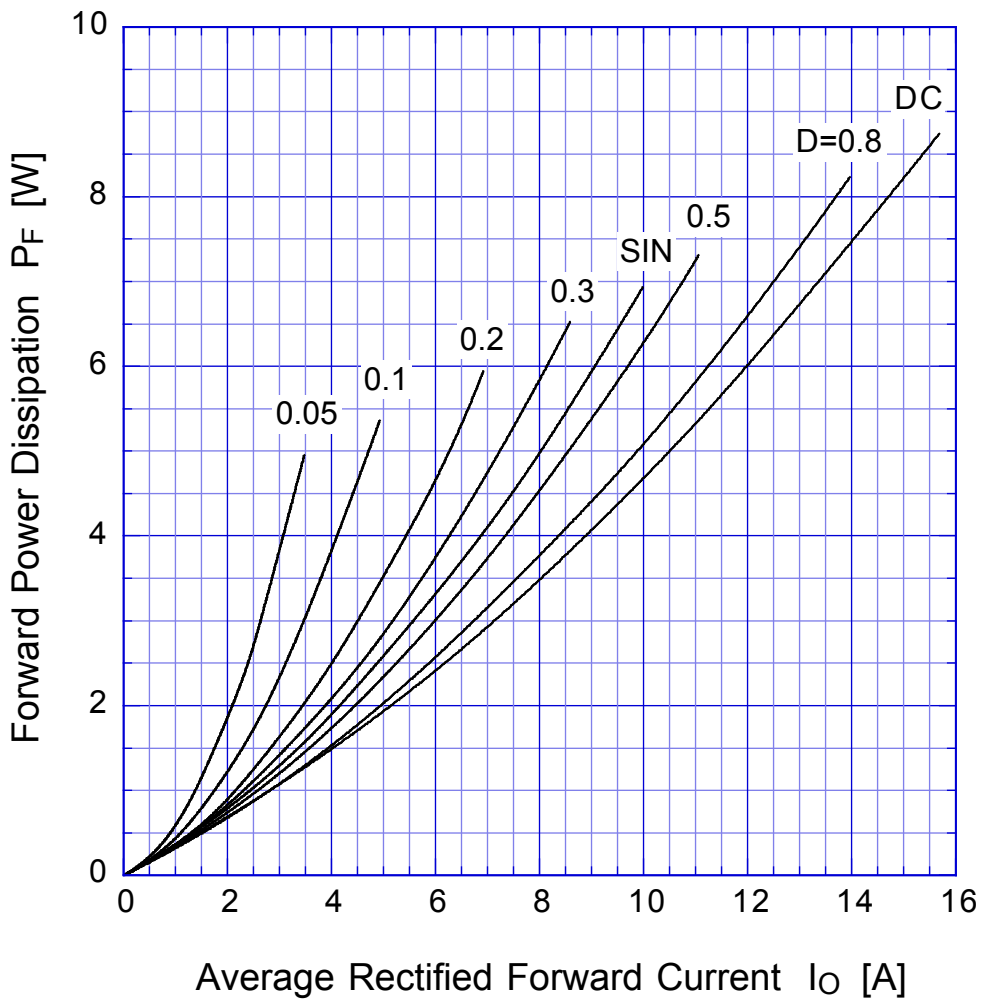

$T_j = 150^\circ\text{C}$

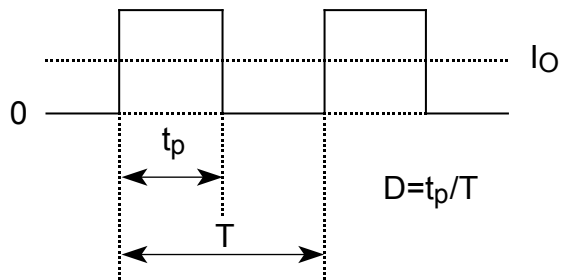

DF10SC4M

Derating Curve

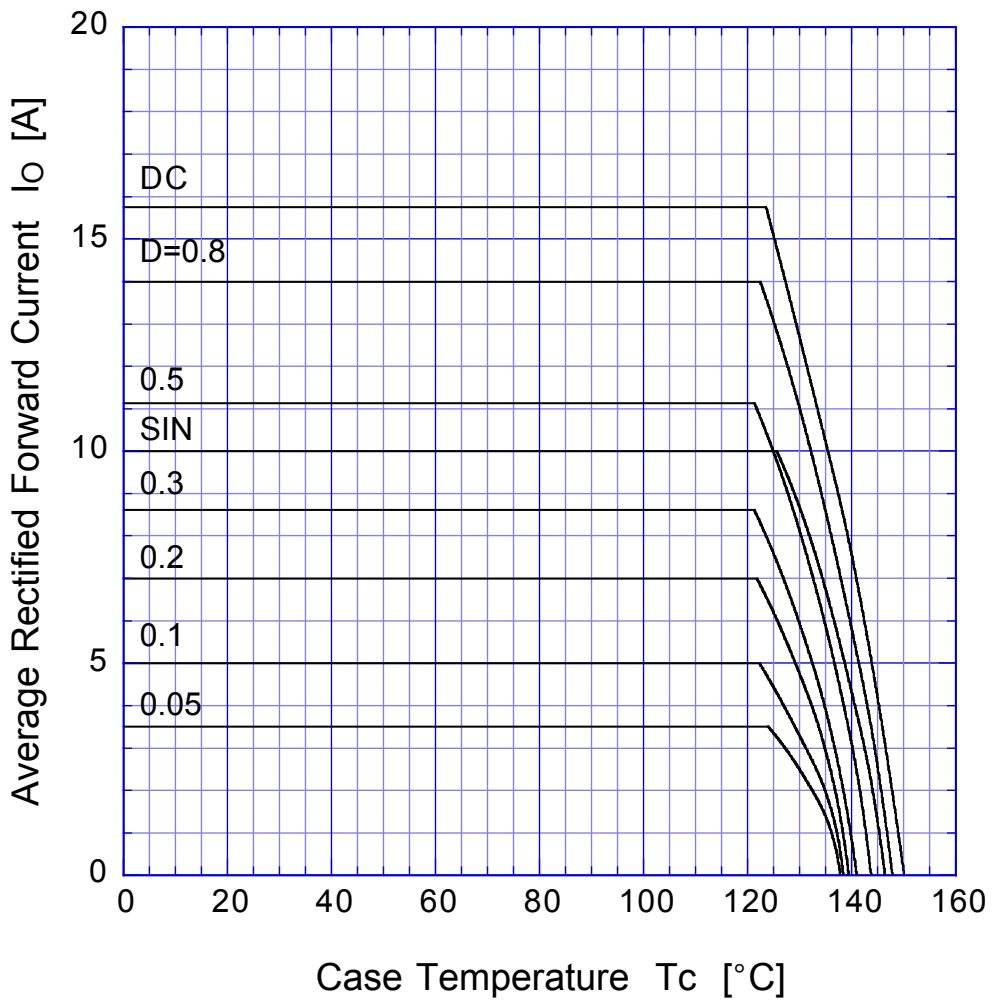

$V_R = 20V$



DF10SC4M

Derating Curve

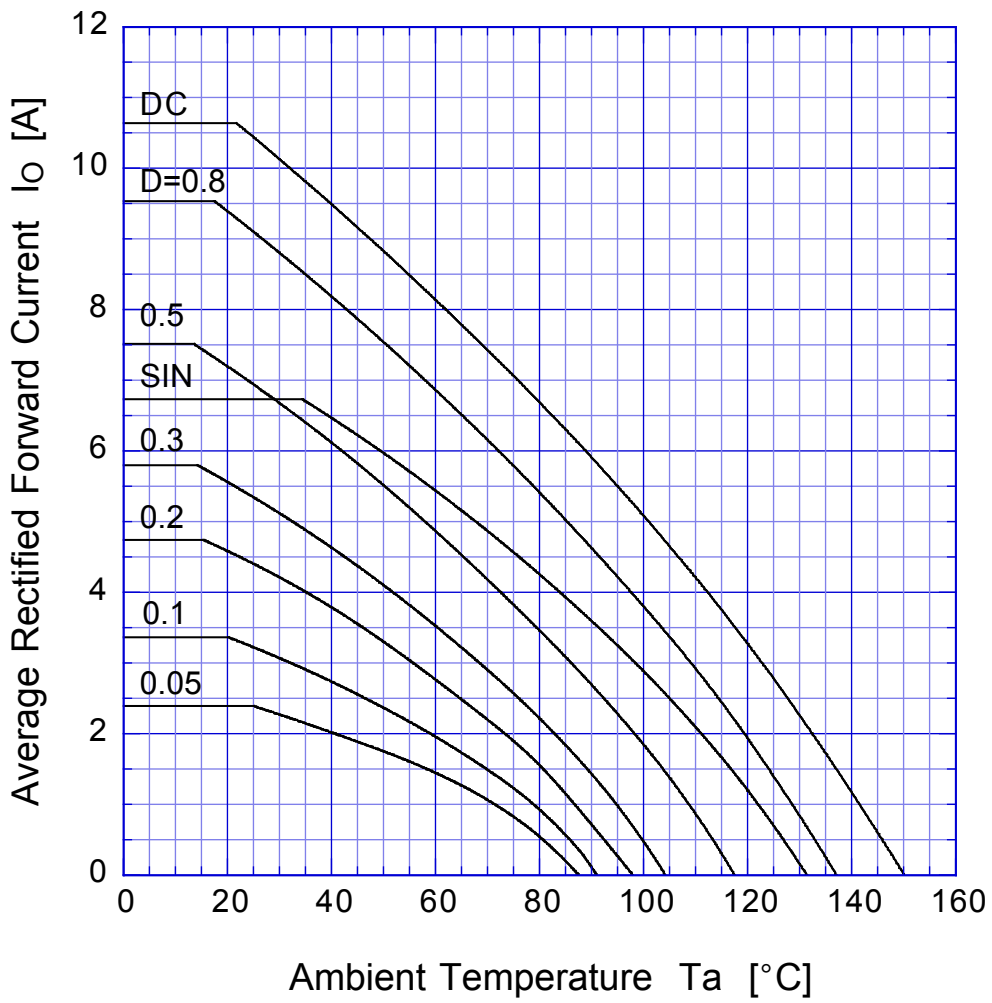

$V_R = 15V$

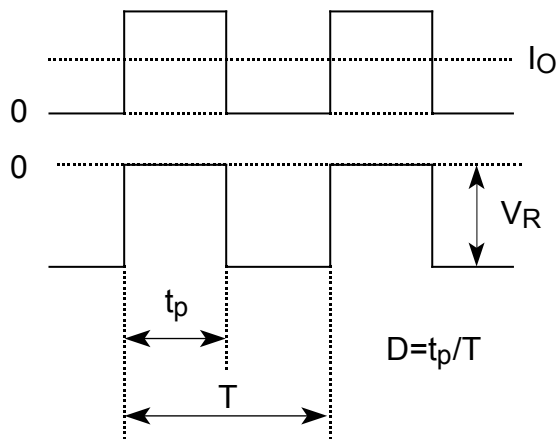

DF10SC4M Peak Surge Forward Capability

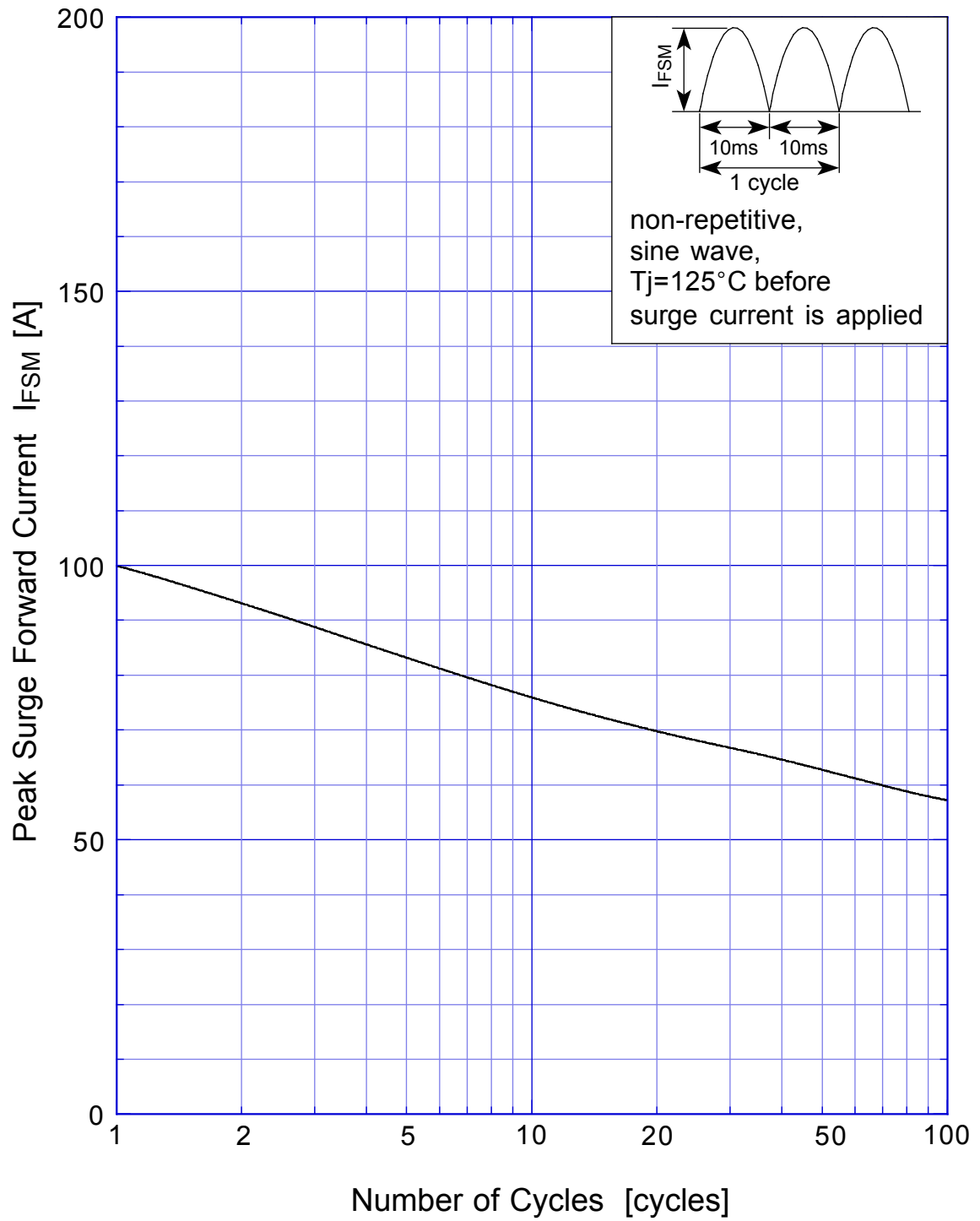

SBD Repetitive Surge Reverse Power Derating Curve

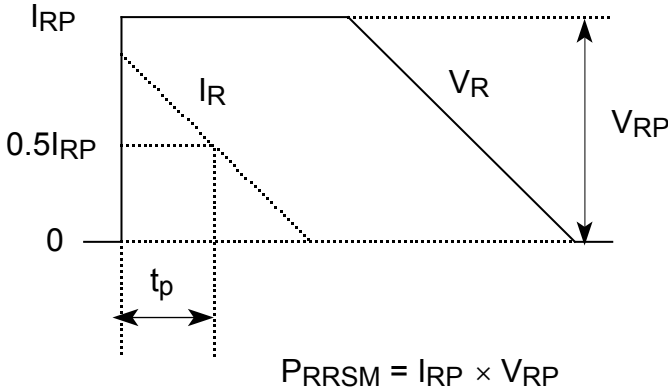
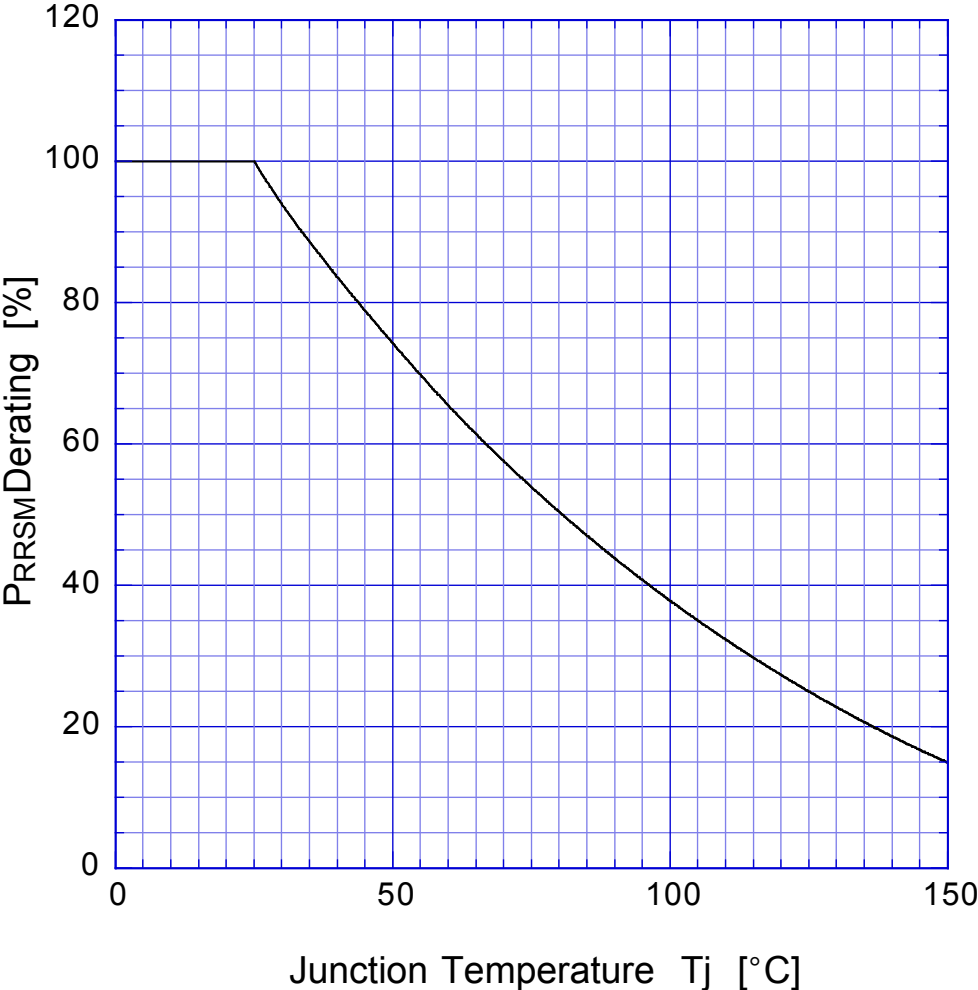

SBD

Repetitive Surge Reverse Power Capability

