

SHINDENGEN

Schottky Barrier Diode

Twin Diode

S15SCA4M

40V 15A

FEATURE

- SMT
- $T_j 150^{\circ}\text{C}$
- P_{RRSM} avalanche guaranteed
- High current capacity with Small Package

APPLICATION

- Switching power supply
- DC/DC converter
- Home Appliances, Office Equipment
- Telecommunication

OUTLINE DIMENSIONS

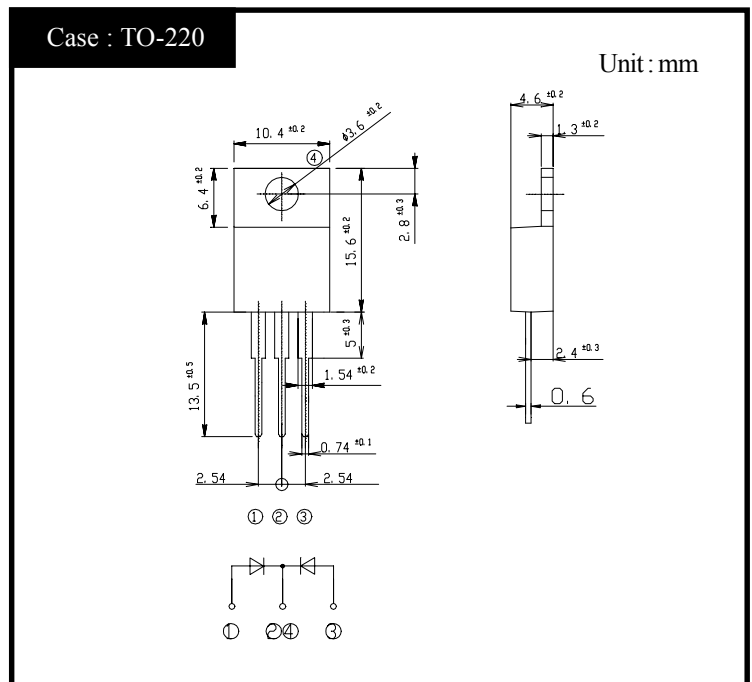

RATINGS

● Absolute Maximum Ratings (If not specified $T_c=25^{\circ}\text{C}$)

Item	Symbol	Conditions	Ratings	Unit
Storage Temperature	T_{stg}		-40~150	$^{\circ}\text{C}$
Operating Junction Temperature	T_j		150	$^{\circ}\text{C}$
Maximum Reverse Voltage	V_{RM}		40	V
Repetitive Peak Surge Reverse Voltage	V_{RRSM}	Pulse width 0.5ms, duty 1/40	45	V
Average Rectified Forward Current	I_O	50Hz sine wave, R-load, $T_c=129^{\circ}\text{C}$	15	A
Peak Surge Forward Current	I_{FSM}	50Hz sine wave, Non-repetitive 1 cycle peak value, $T_j=125^{\circ}\text{C}$	150	A
Repetitive Peak Surge Reverse Power	P_{RRSM}	Pulse width 10 μ s, Rating of per diode, $T_j=25^{\circ}\text{C}$	330	W
Mounting Torque	TOR	(Recommended torque:0.3N·m)	0.5	N·m

● Electrical Characteristics (If not specified $T_c=25^{\circ}\text{C}$)

Item	Symbol	Conditions	Ratings	Unit
Forward Voltage	V_F	$I_F=7.5\text{A}$, Pulse measurement, Rating of per diode	Max.0.55	V
Reverse Current	I_R	$V_R=V_{RM}$, Pulse measurement, Rating of per diode	Max.5	mA
Junction Capacitance	C_j	$f=1\text{MHz}$, $V_R=10\text{V}$, Rating of per diode	Typ.340	pF
Thermal Resistance	θ_{jc}	junction to case	Max.1.7	$^{\circ}\text{C}/\text{W}$

S15SCA4M Forward Voltage

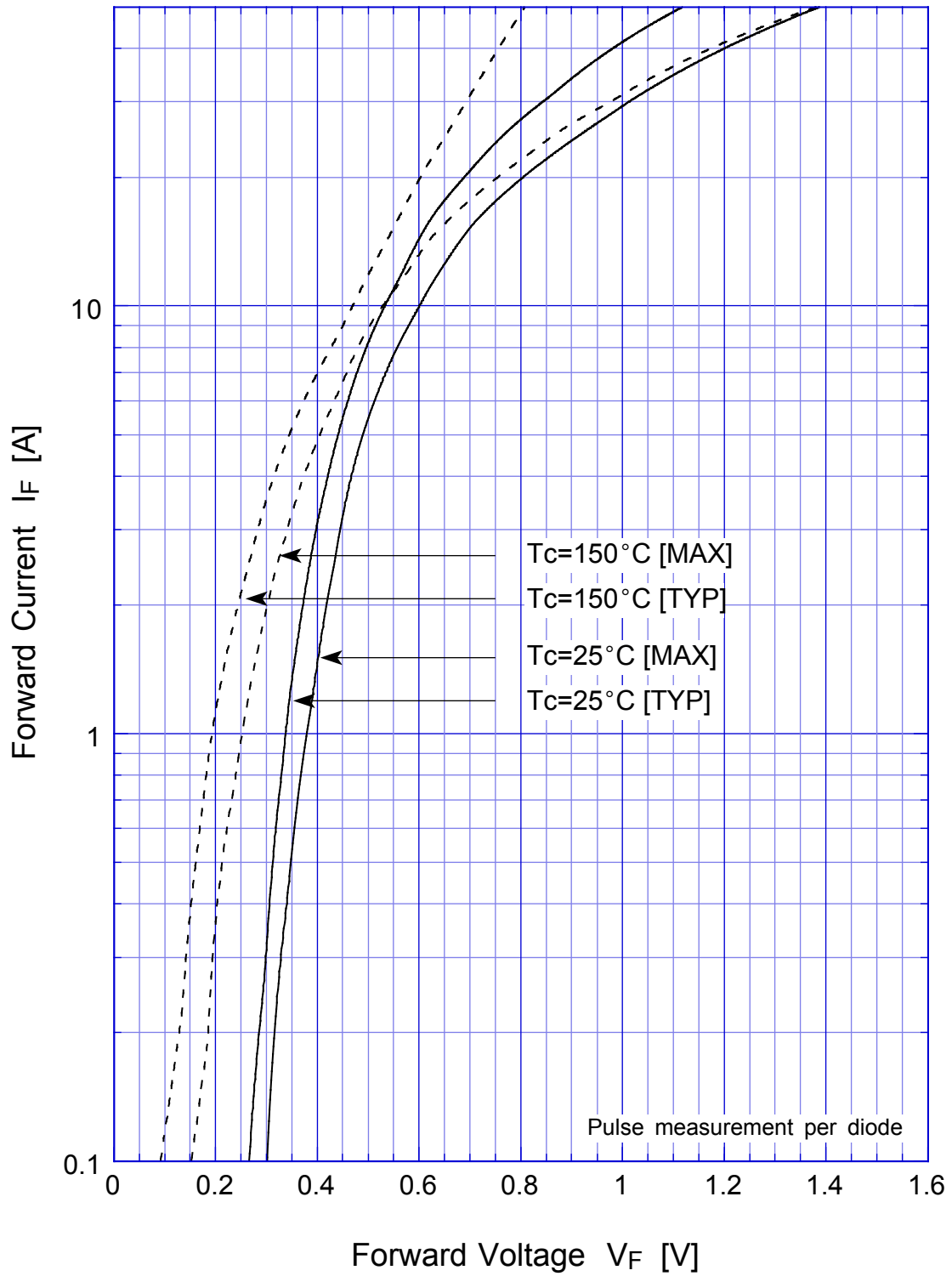

S15SCA4M Junction Capacitance

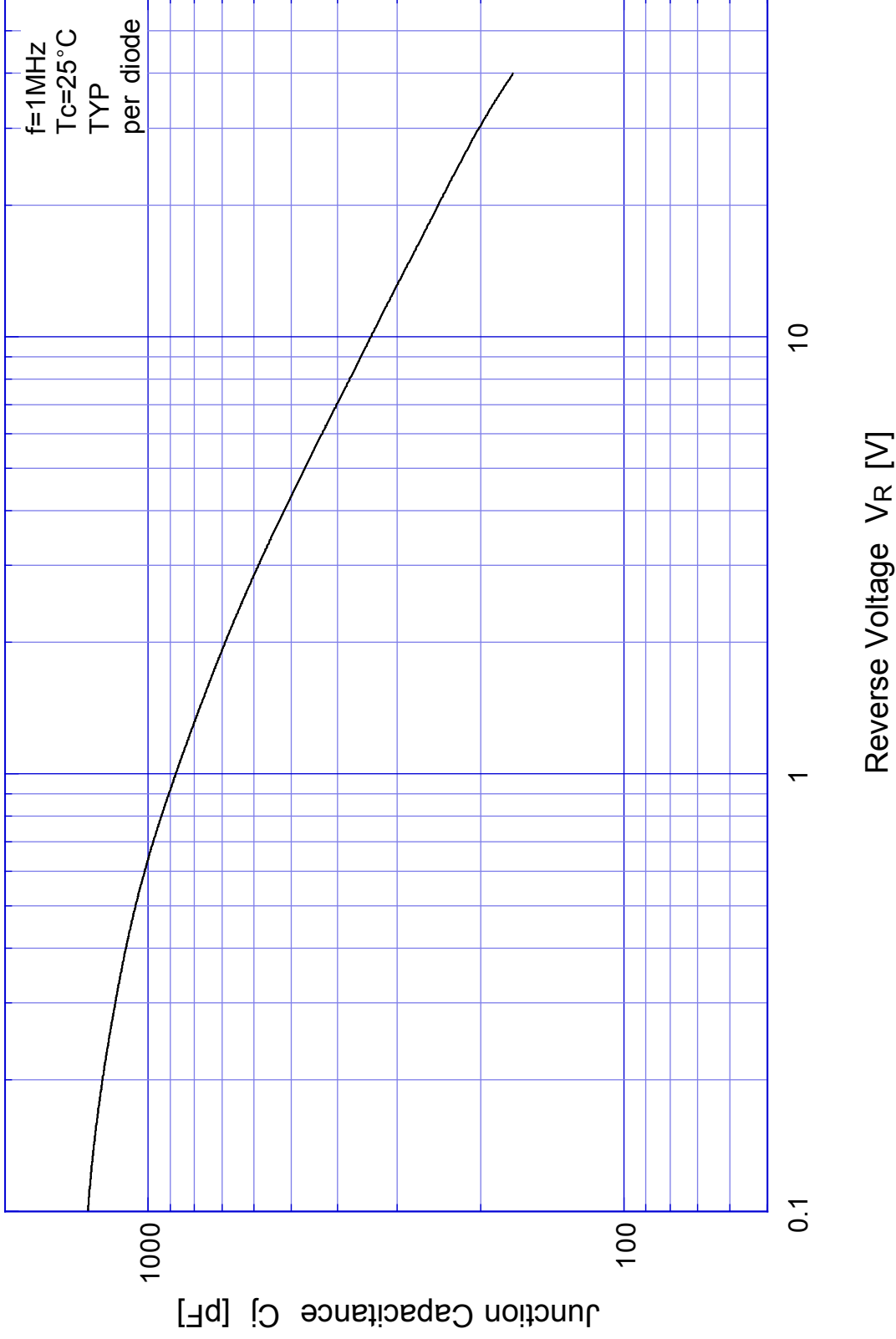

S15SCA4M Reverse Current

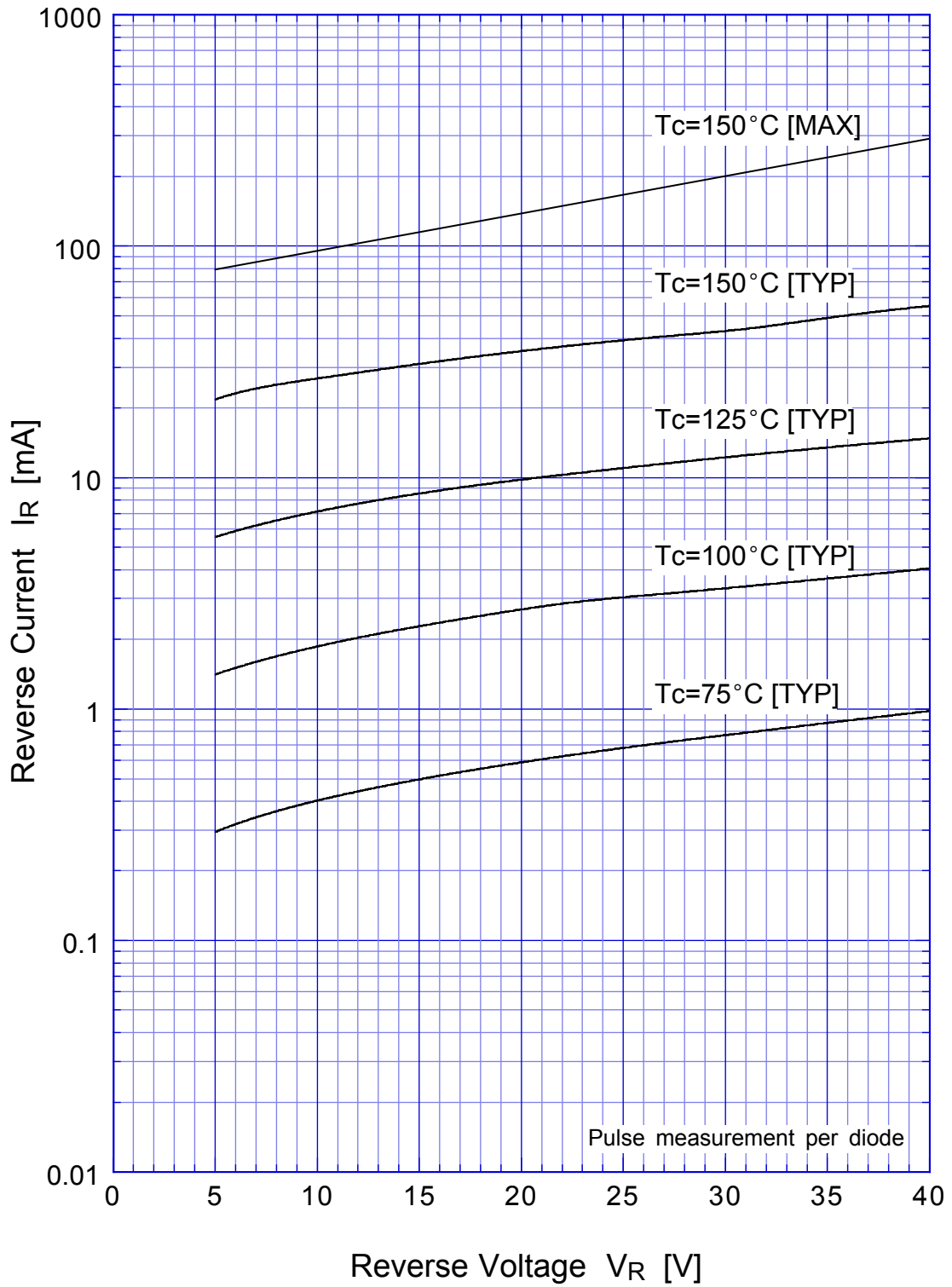

S15SCA4M Reverse Power Dissipation

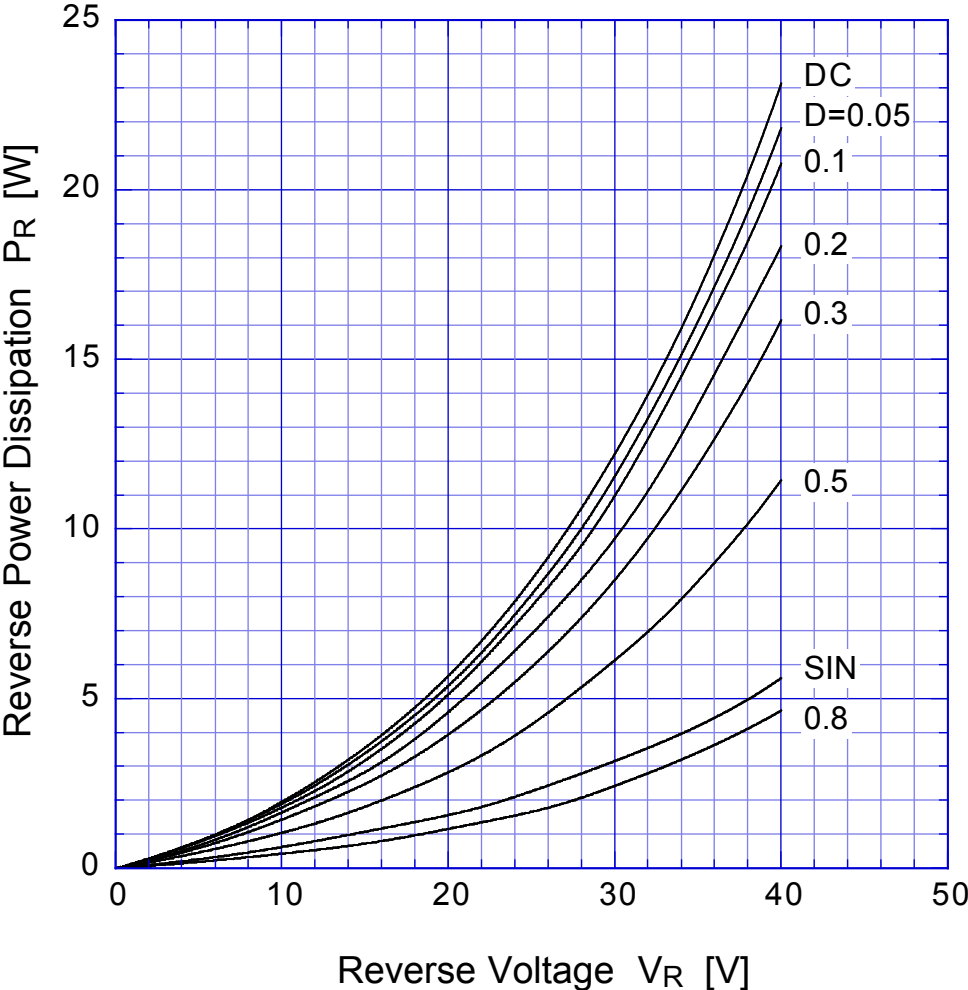

$T_j = 150^\circ\text{C}$

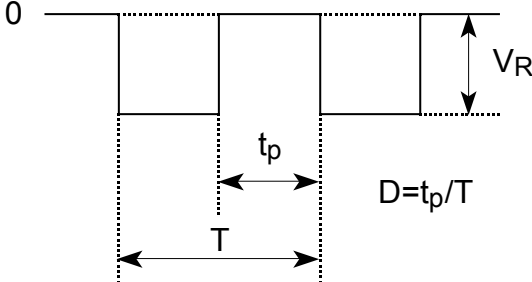

S15SCA4M Forward Power Dissipation

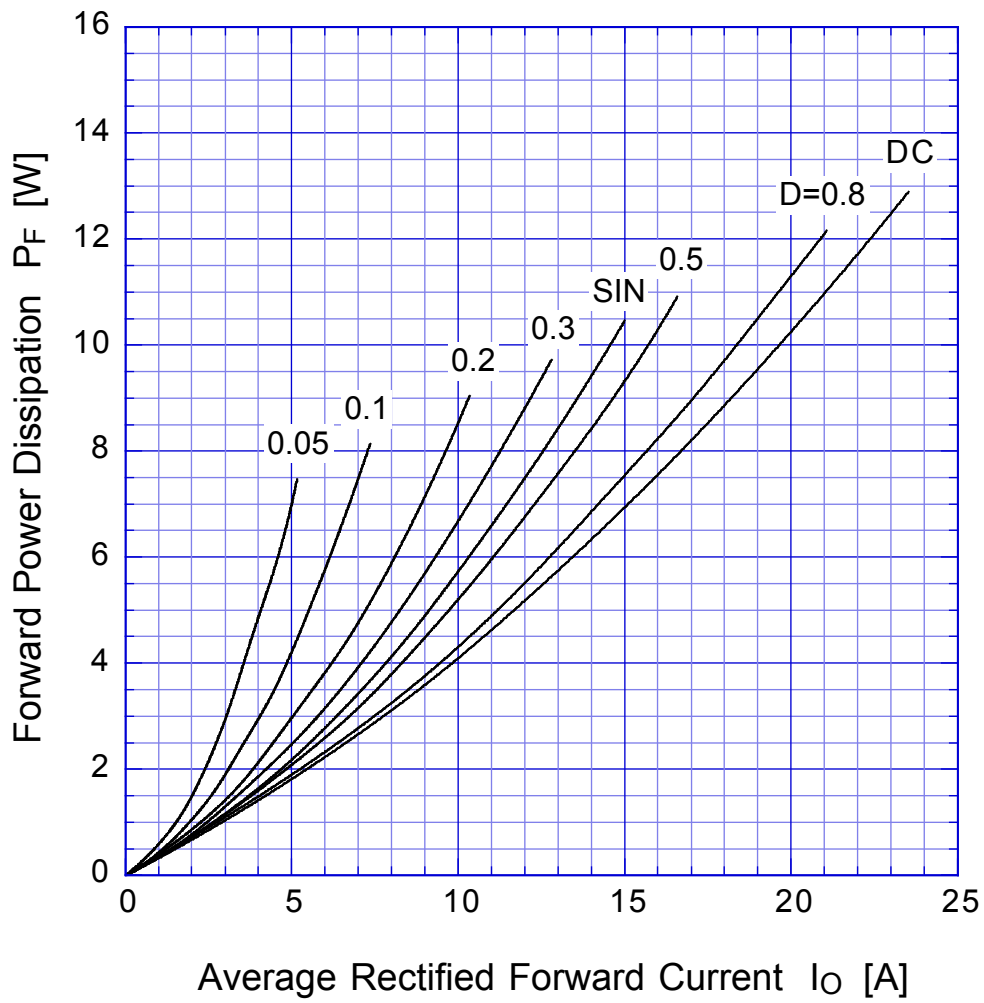

$T_j = 150^\circ\text{C}$

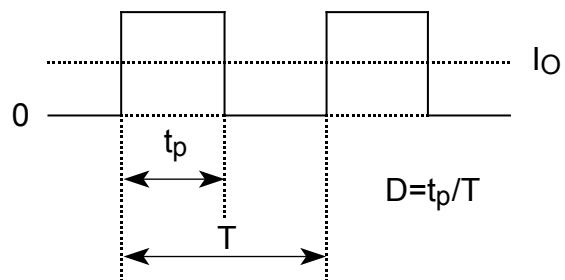

S15SCA4M

Derating Curve

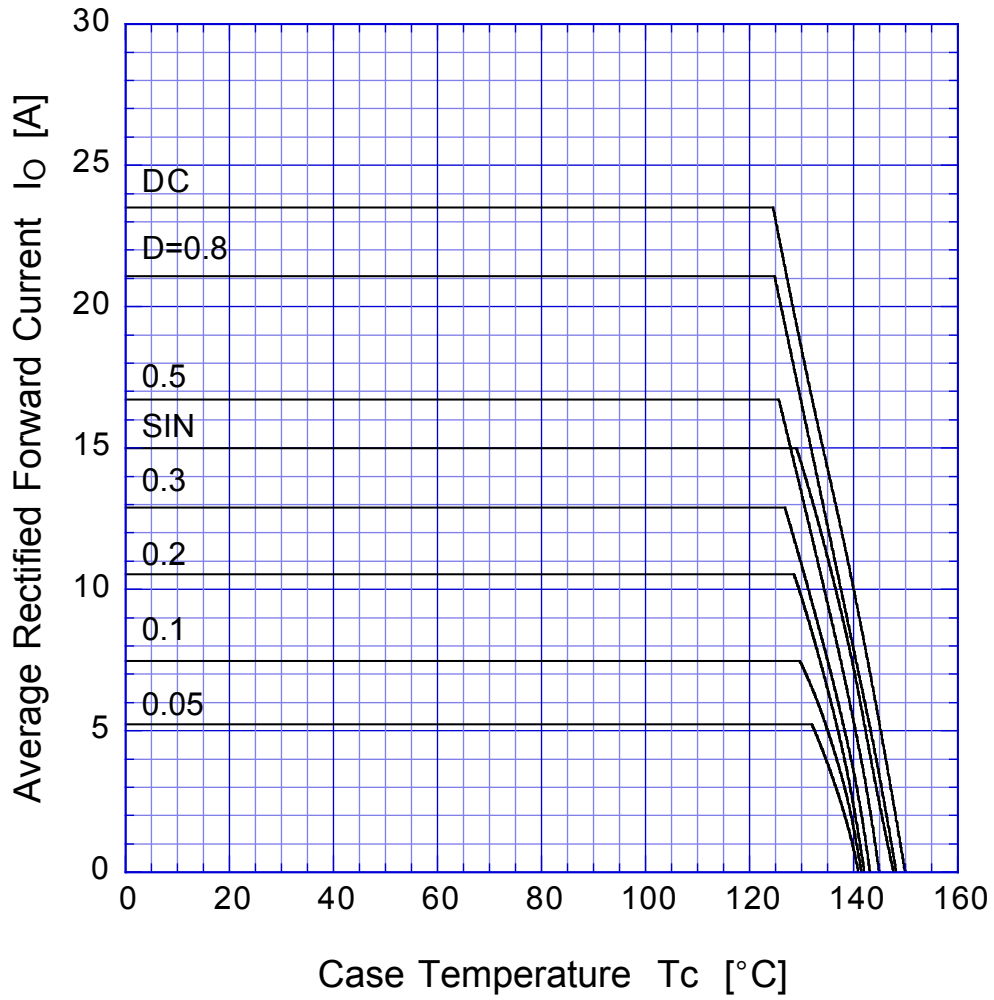

$V_R = 20V$

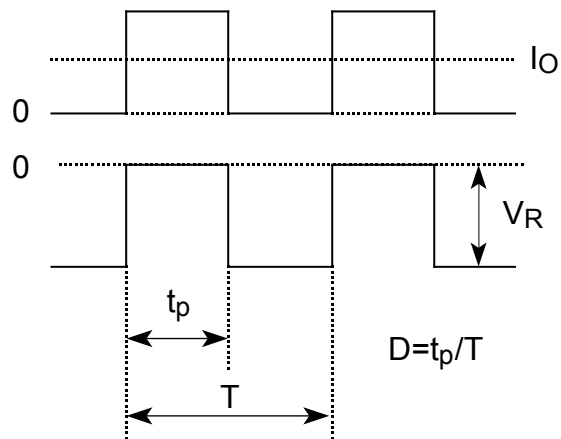

S15SCA4M Peak Surge Forward Capability

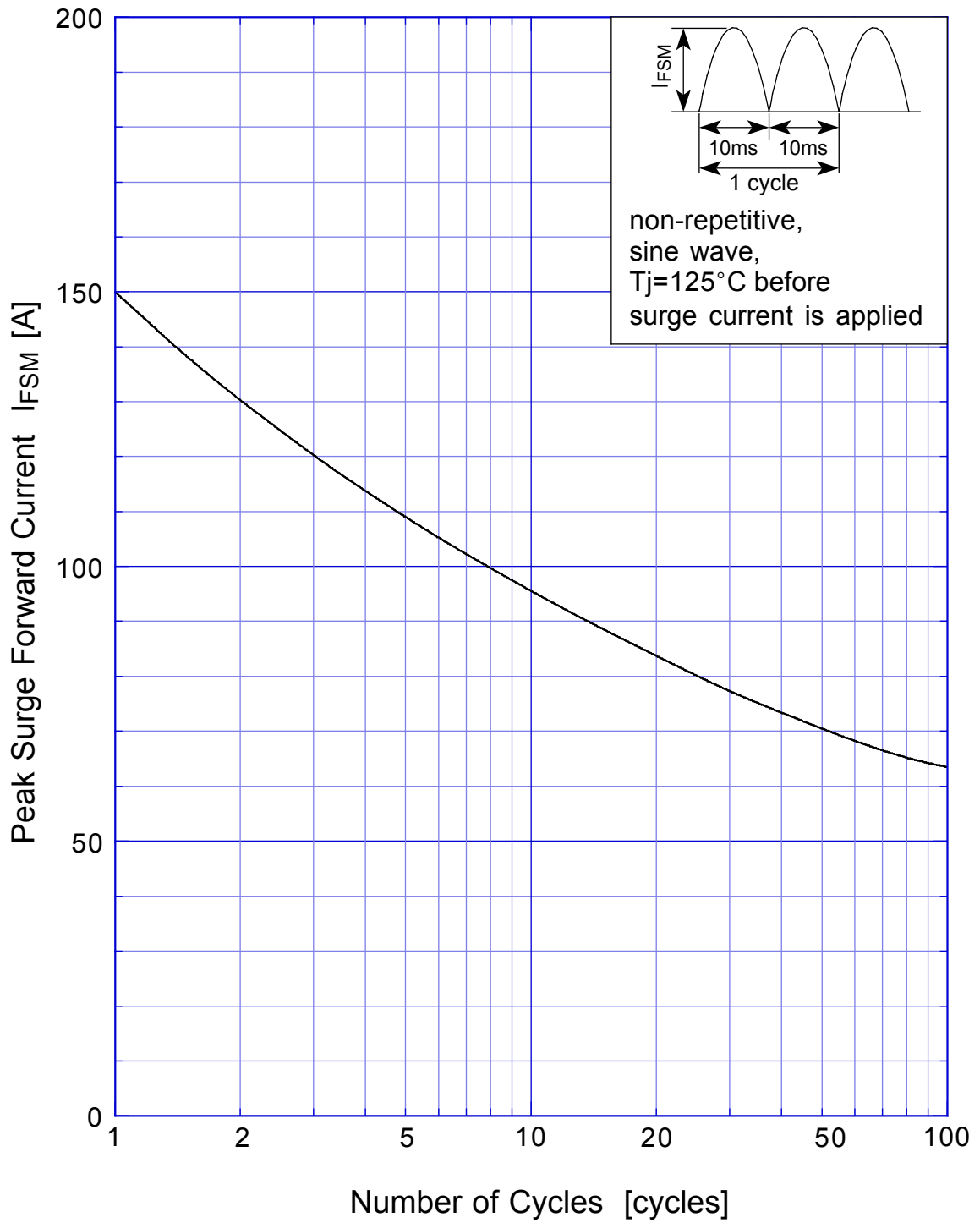

SBD Repetitive Surge Reverse Power Derating Curve

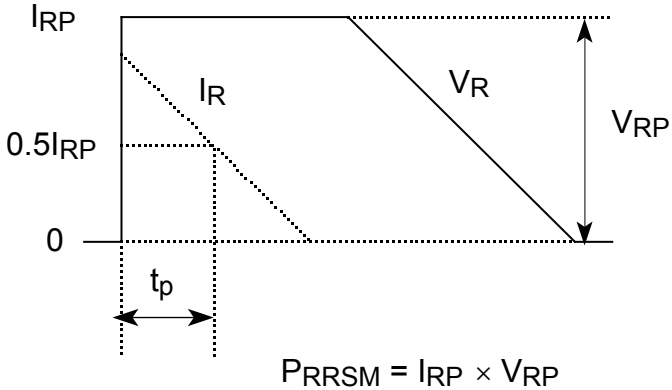
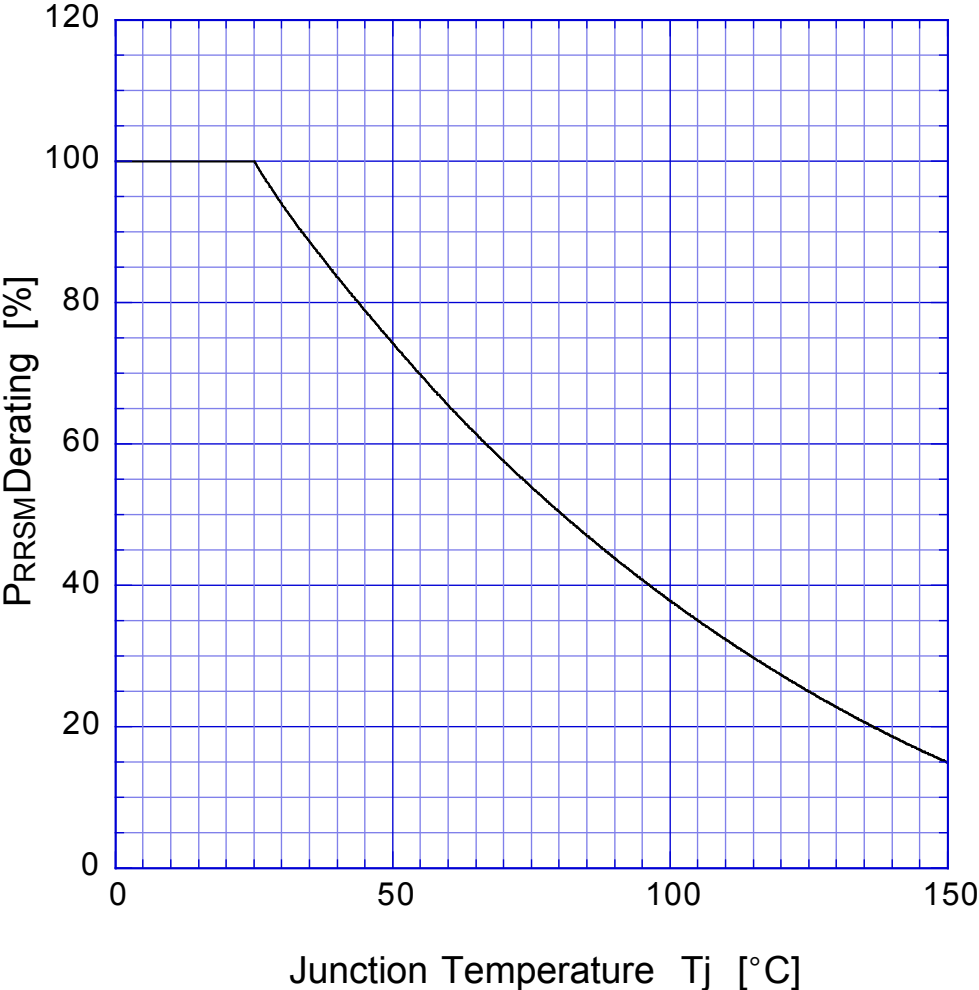

SBD

Repetitive Surge Reverse Power Capability

