

SHINDENGEN

Schottky Rectifiers (SBD)

Dual

SF20SC3L

30V 20A

FEATURES

- Tj150
- Low $V_F = 0.45V$
- P_{RRSM} avalanche guaranteed
- Fully Isolated Molding
- Dielectric strength 2kV guaranteed

APPLICATION

- Switching power supply
- DC/DC converter
- Home Appliances, Office Equipment
- Telecommunication

OUTLINE DIMENSIONS

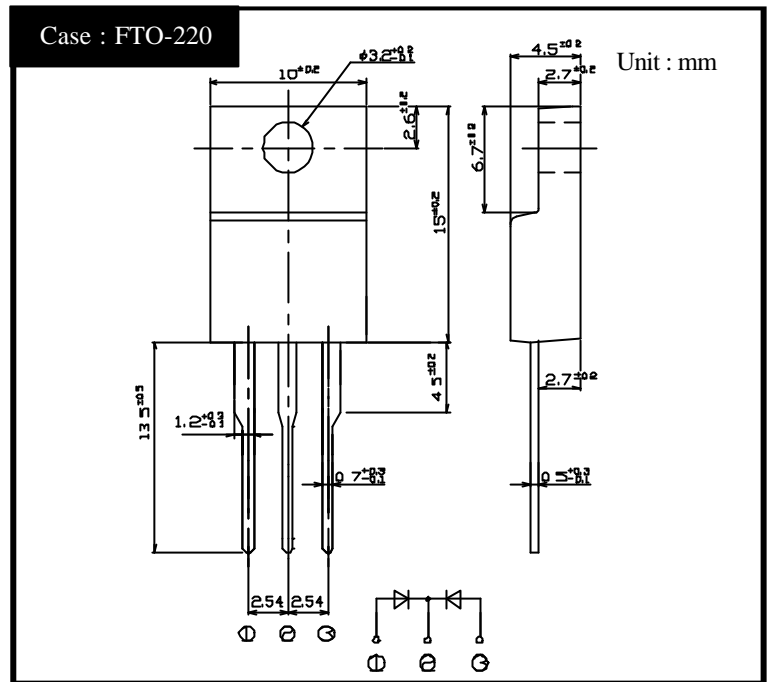

RATINGS

Absolute Maximum Ratings (If not specified $T_c=25$)

Item	Symbol	Conditions	Ratings	Unit
Storage Temperature	Tstg		-55 ~ 150	
Operating Junction Temperature	Tj		150	
Maximum Reverse Voltage	V_{RM}		30	V
Repetitive Peak Surge Reverse Voltage	V_{RRSM}	Pulse width 0.5ms, duty 1/40	35	V
Average Rectified Forward Current	I_o	50Hz sine wave, R-load, With heatsink, Rating for each diode $I_o/2$, $T_c=125$	20	A
Peak Surge Forward Current	I_{FSM}	50Hz sine wave, Non-repetitive 1 cycle peak value, $T_j=25$	230	A
Repetitive Peak Surge Reverse Power	P_{RRSM}	Pulse width 10 μ s, Rating of per diode, $T_j=25$	660	W
Dielectric Strength	Vdis	Terminals to case, AC 1 minute	2	kV
Mounting Torque	TOR	(Recommended torque 0.3N·m)	0.5	N·m

Electrical Characteristics (If not specified $T_c=25$)

Item	Symbol	Conditions	Ratings	Unit
Forward Voltage	V_F	$I_F=8A$, Pulse measurement, Rating of per diode	Max.0.45	V
Reverse Current	I_R	$V_R=V_{RM}$, Pulse measurement, Rating of per diode	Max.9	mA
Junction Capacitance	Cj	f=1MHz, $V_R=10V$, Rating of per diode	Typ.570	pF
Thermal Resistance	θ_c	junction to case	Max.2.0	/W

SF20SC3L Forward Voltage

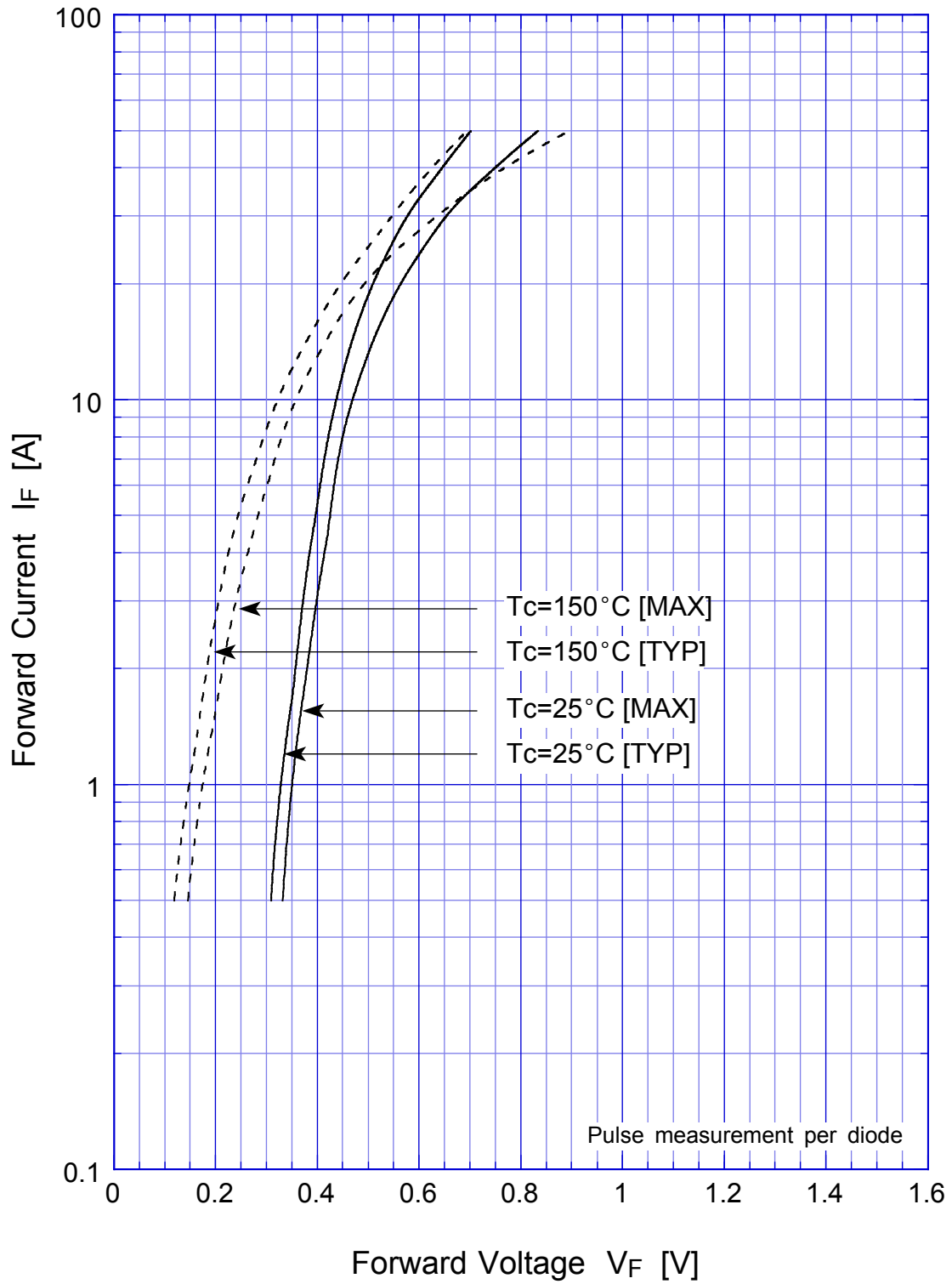

SF20SC3L Junction Capacitance

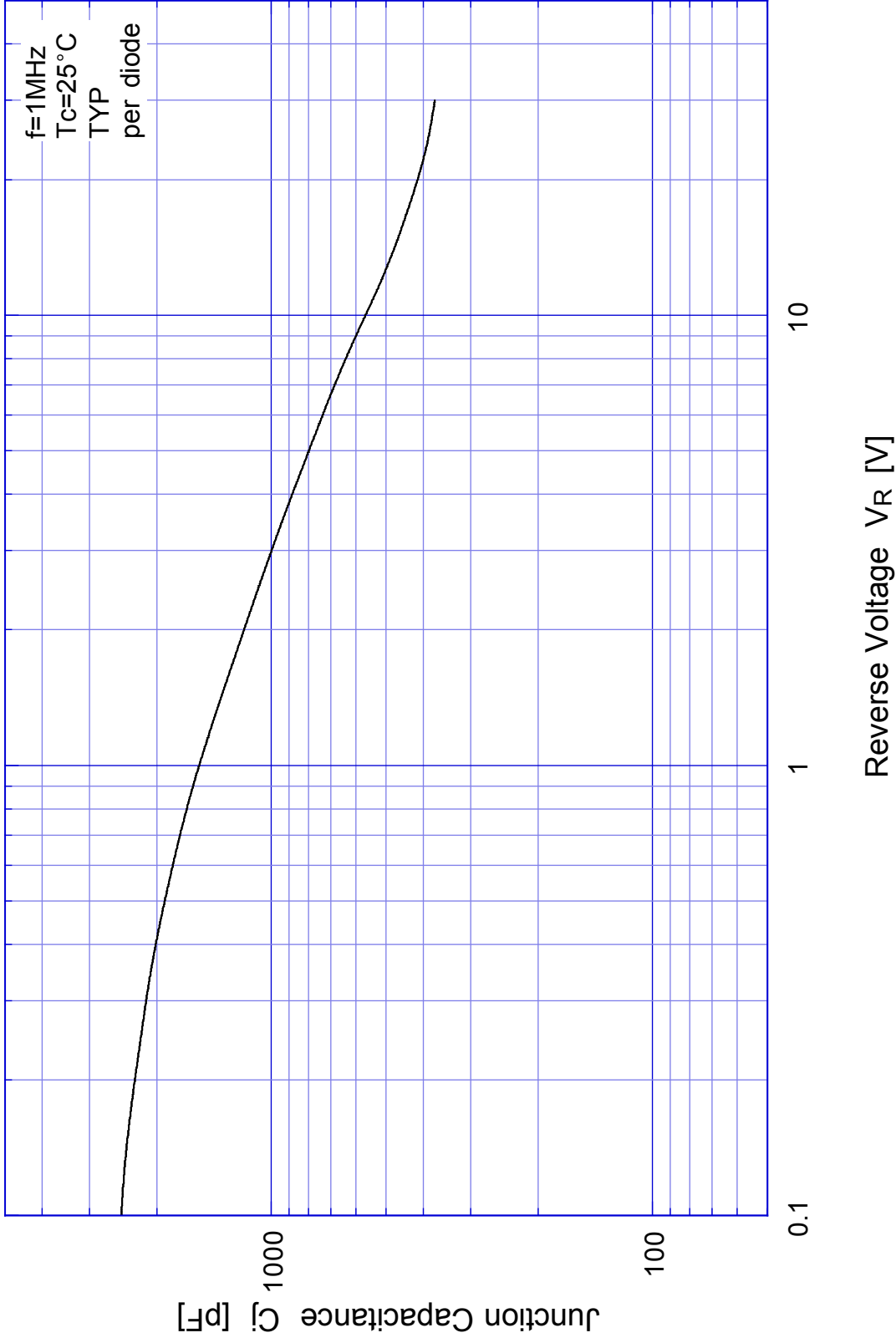

SF20SC3L Reverse Current

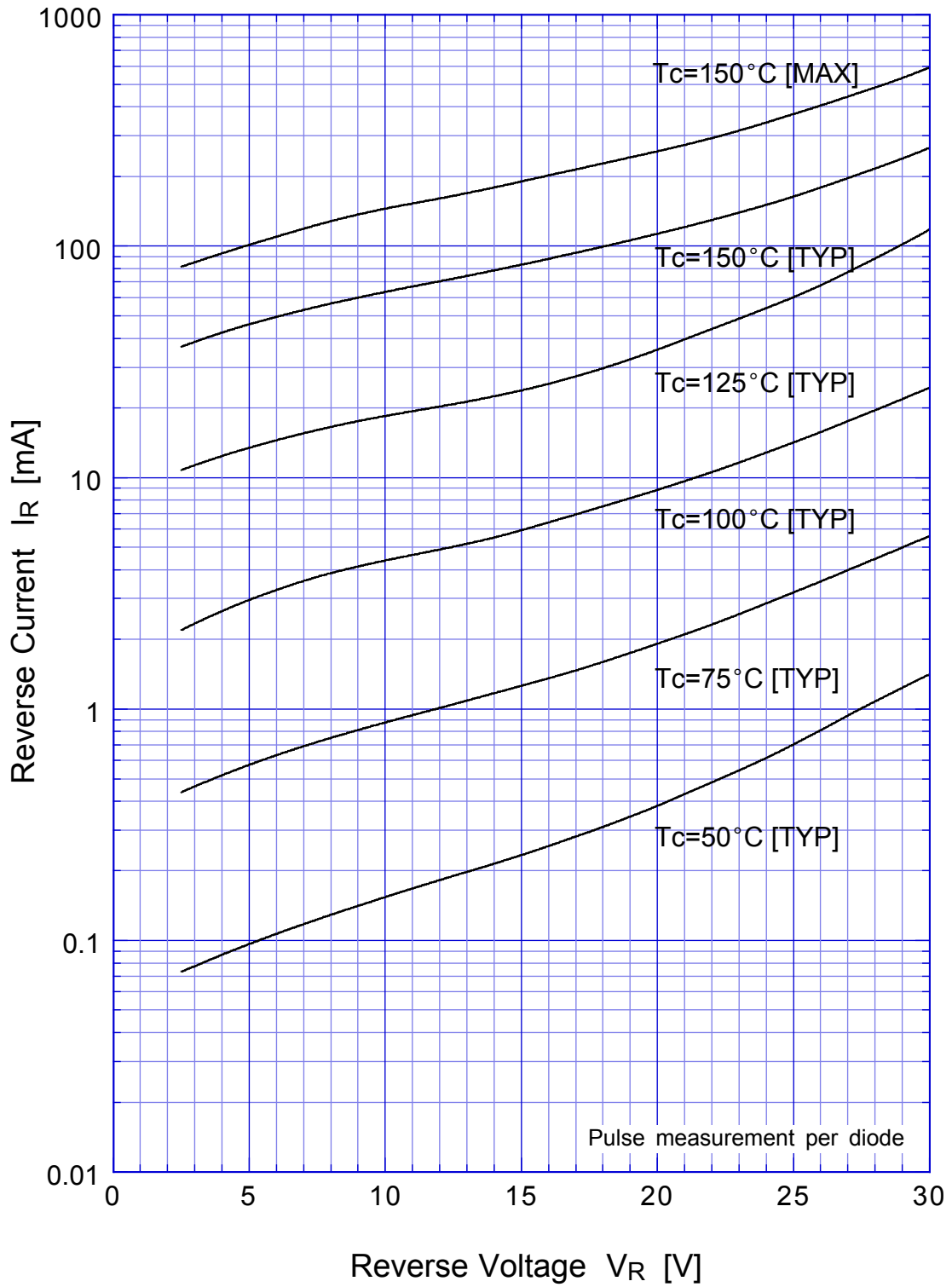

SF20SC3L Reverse Power Dissipation

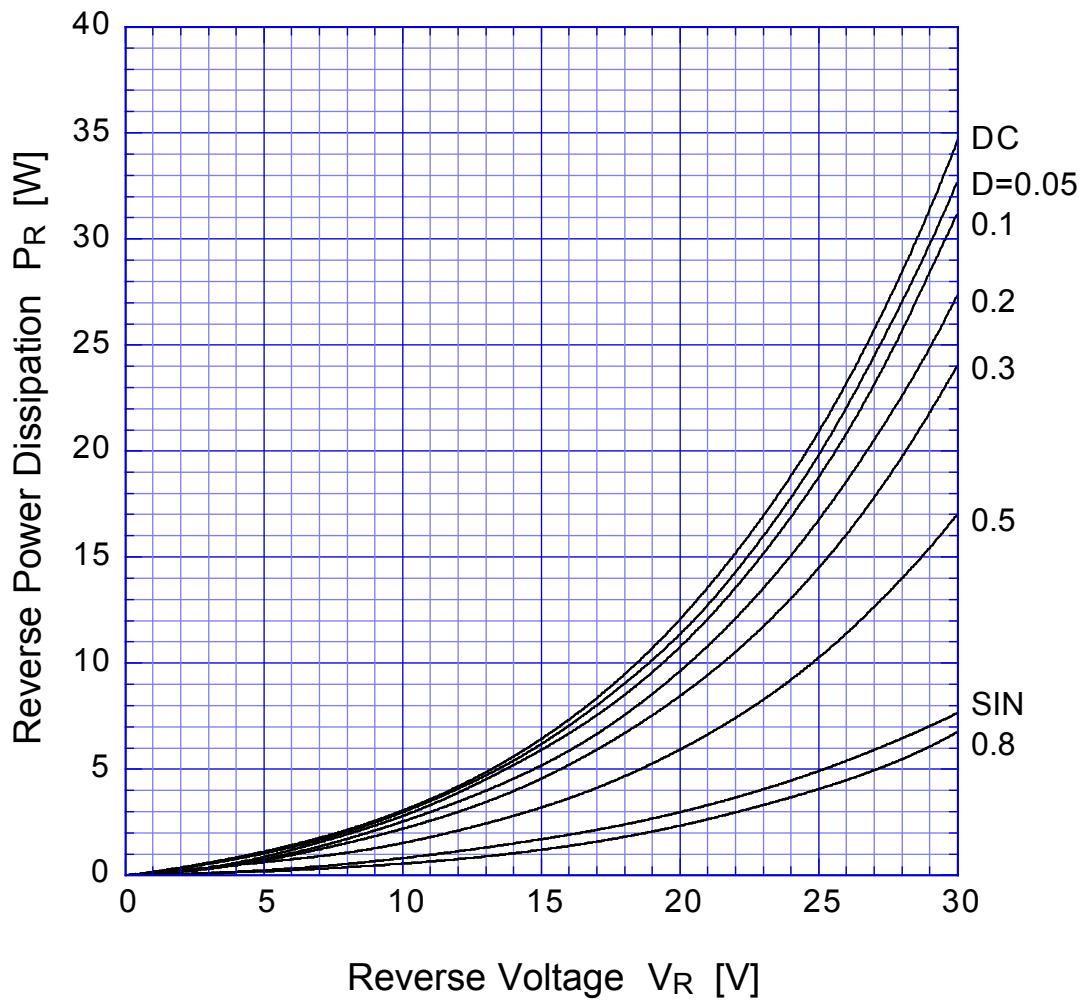

$T_j = T_{jmax}$

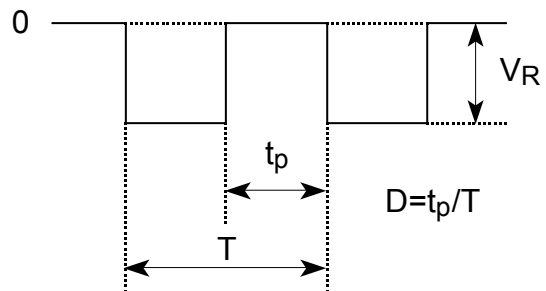

SF20SC3L Forward Power Dissipation

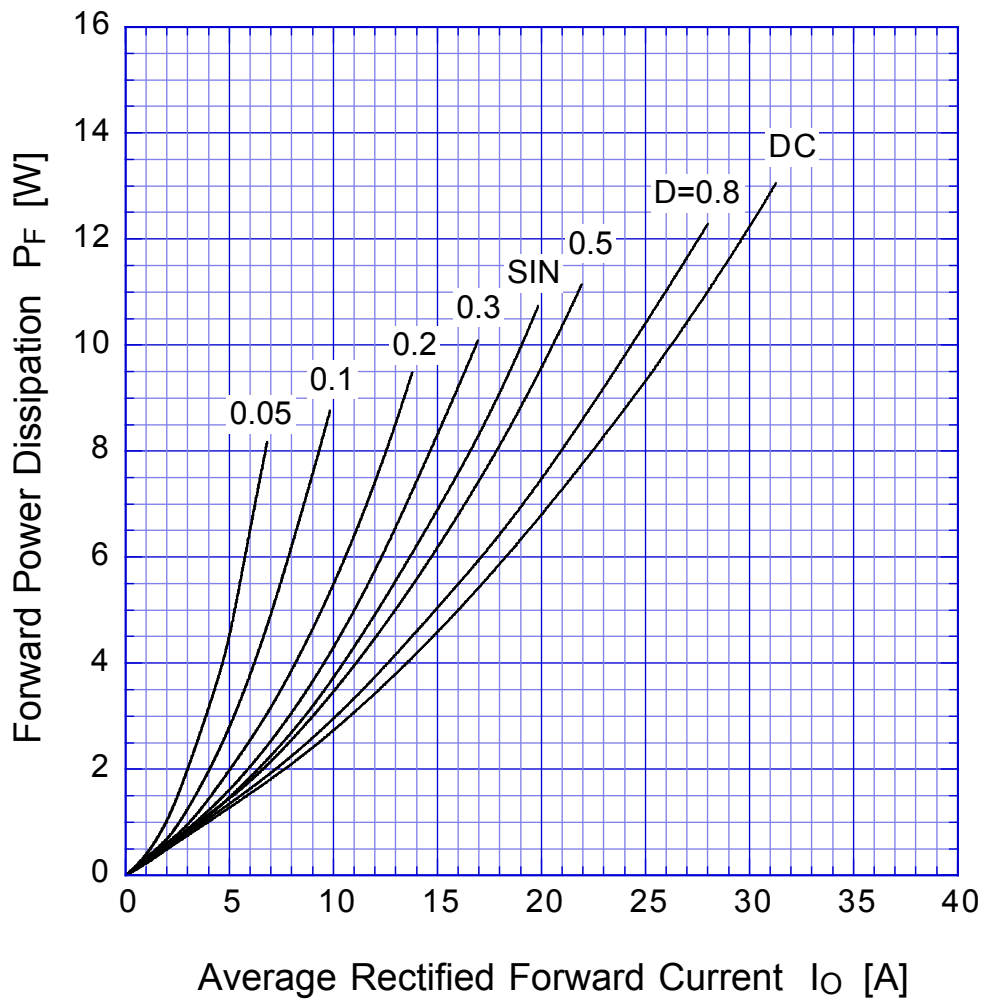

$T_j = T_{jmax}$



SF20SC3L

Derating Curve

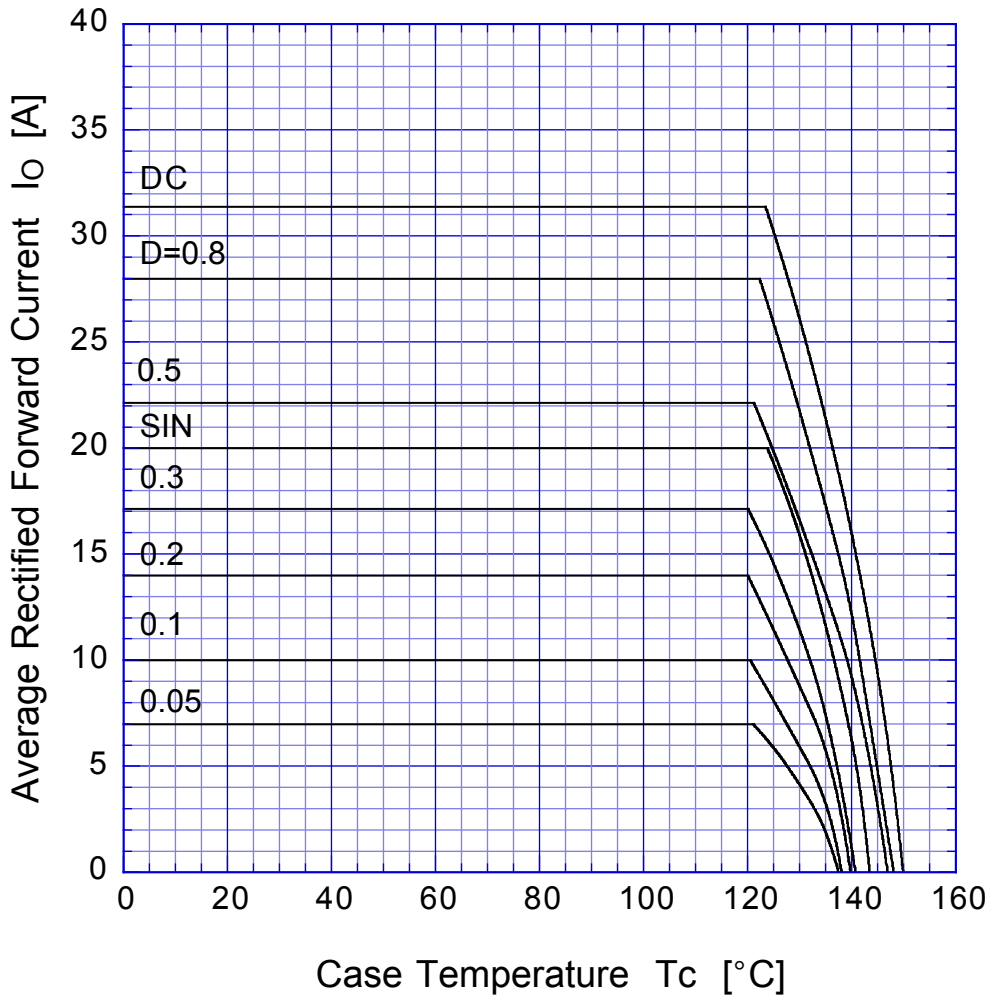

$$V_R = V_{RM}/2$$

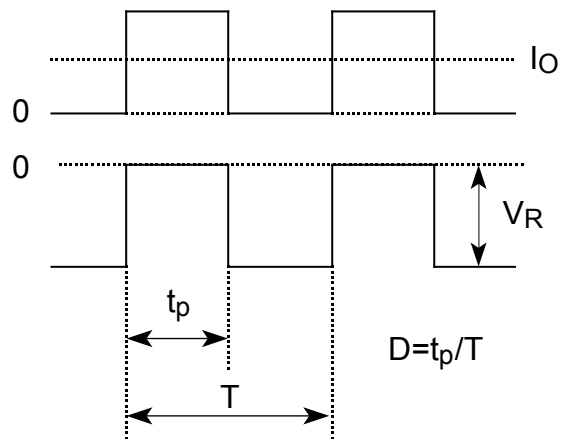

SF20SC3L Peak Surge Forward Capability

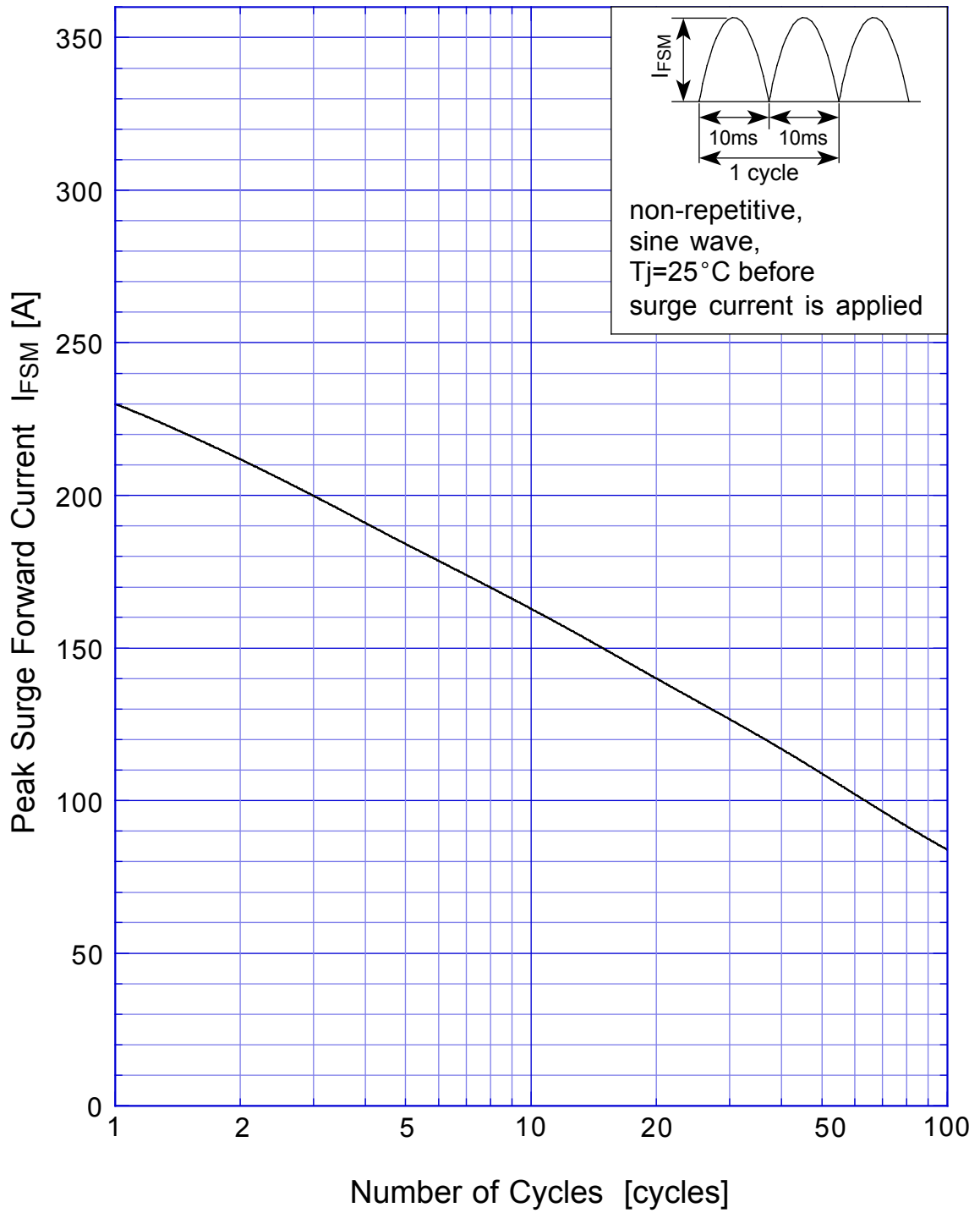

SBD Repetitive Surge Reverse Power Derating Curve

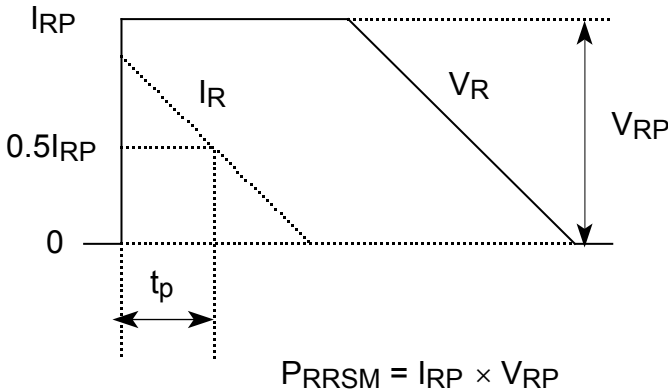
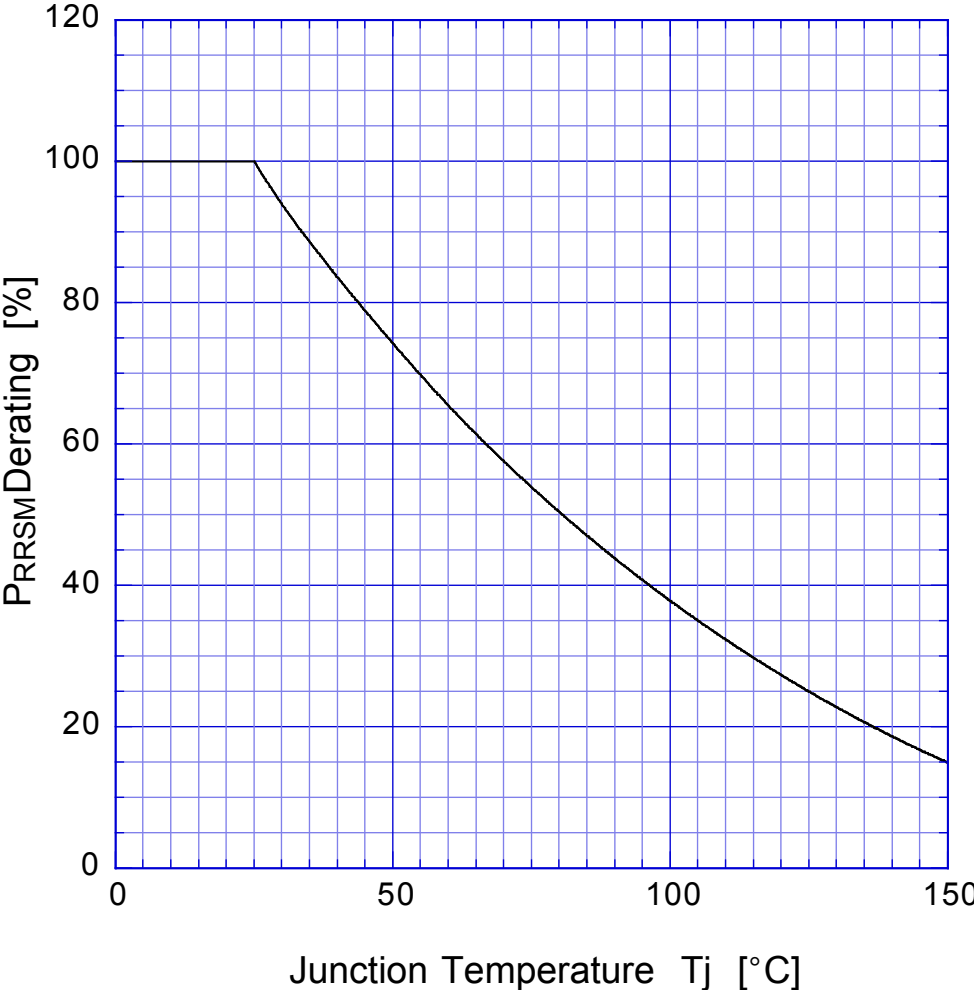

SBD

Repetitive Surge Reverse Power Capability

