

D25SC6MR Forward Voltage

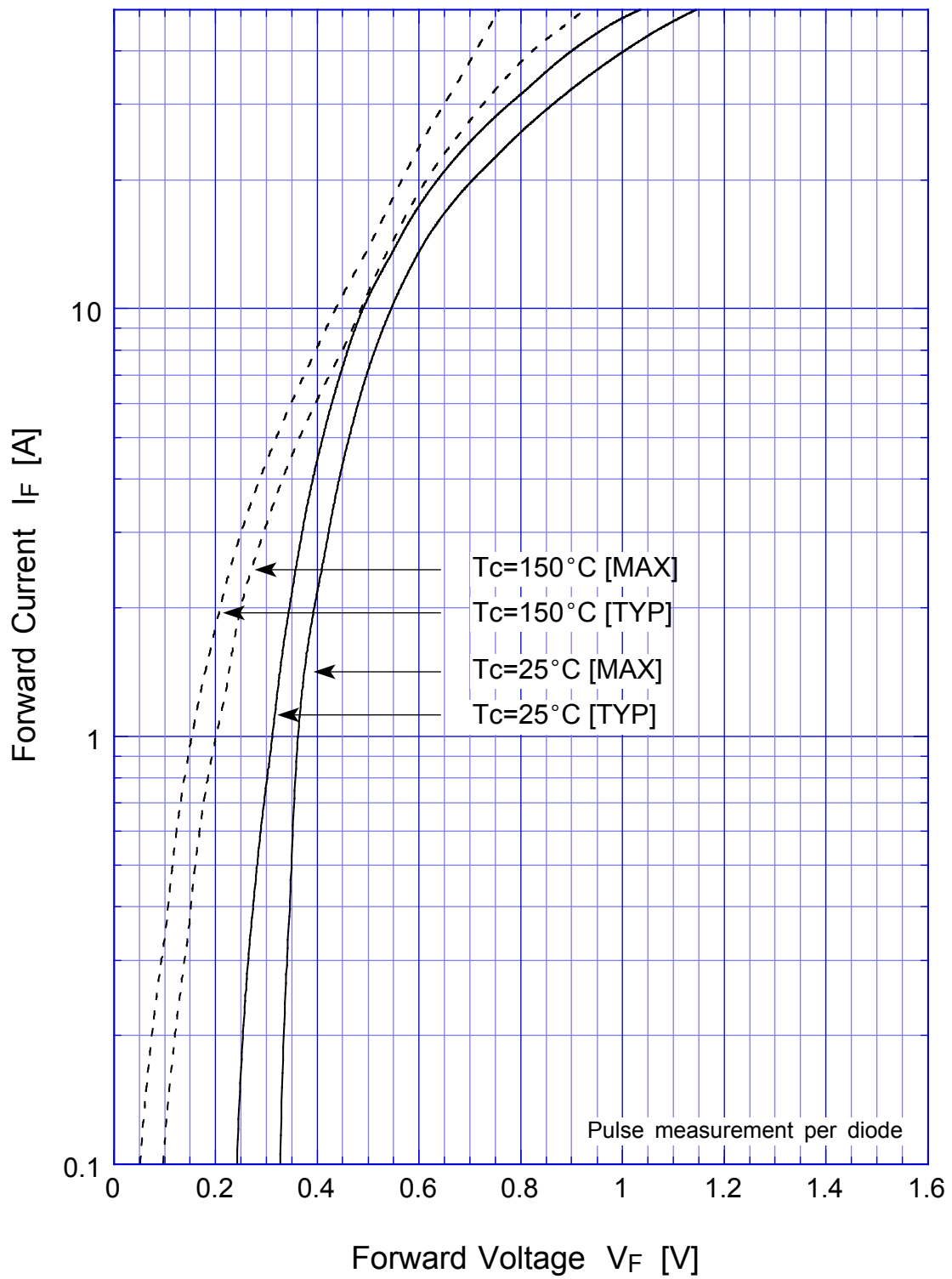

D25SC6MR Junction Capacitance

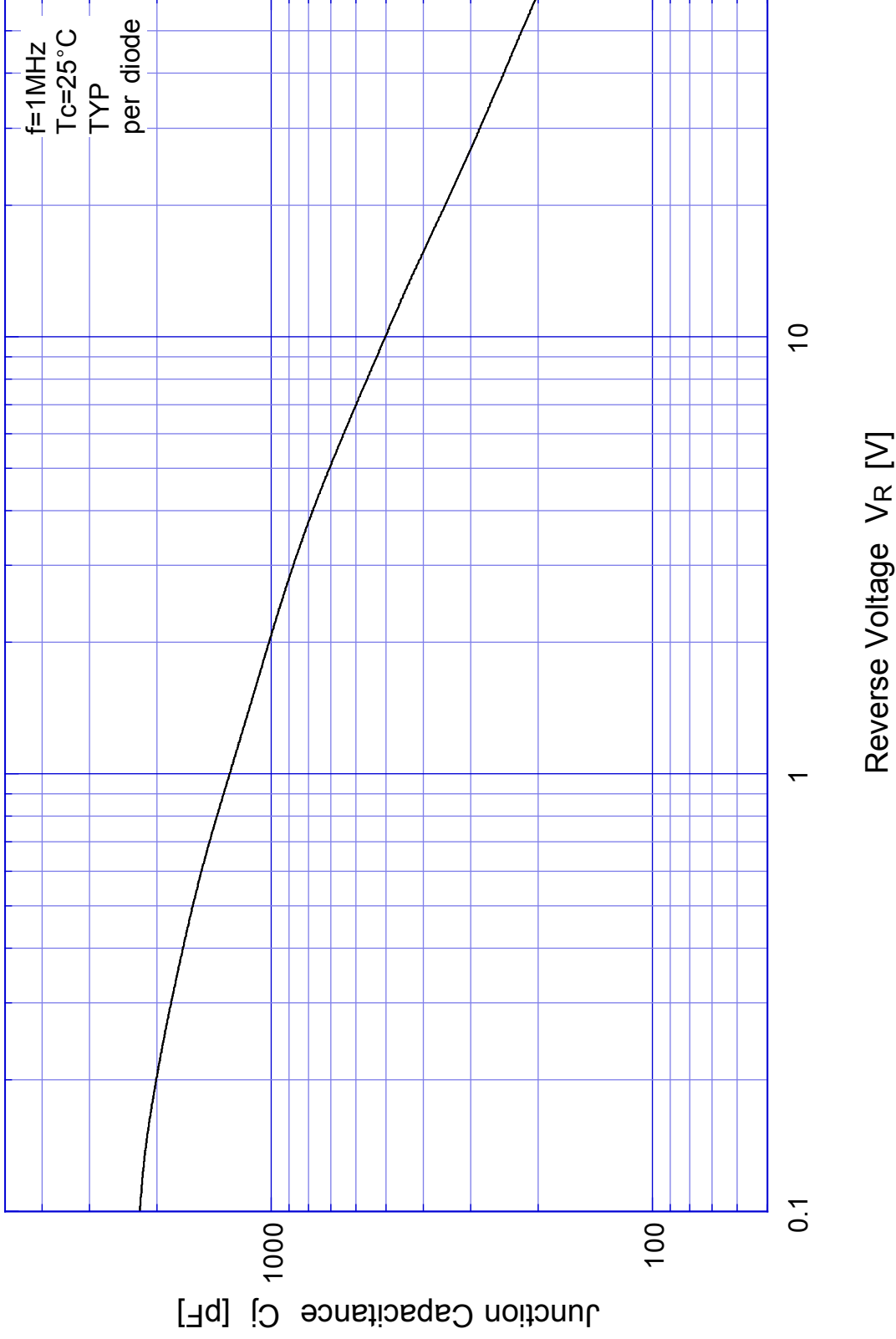

D25SC6MR Reverse Current

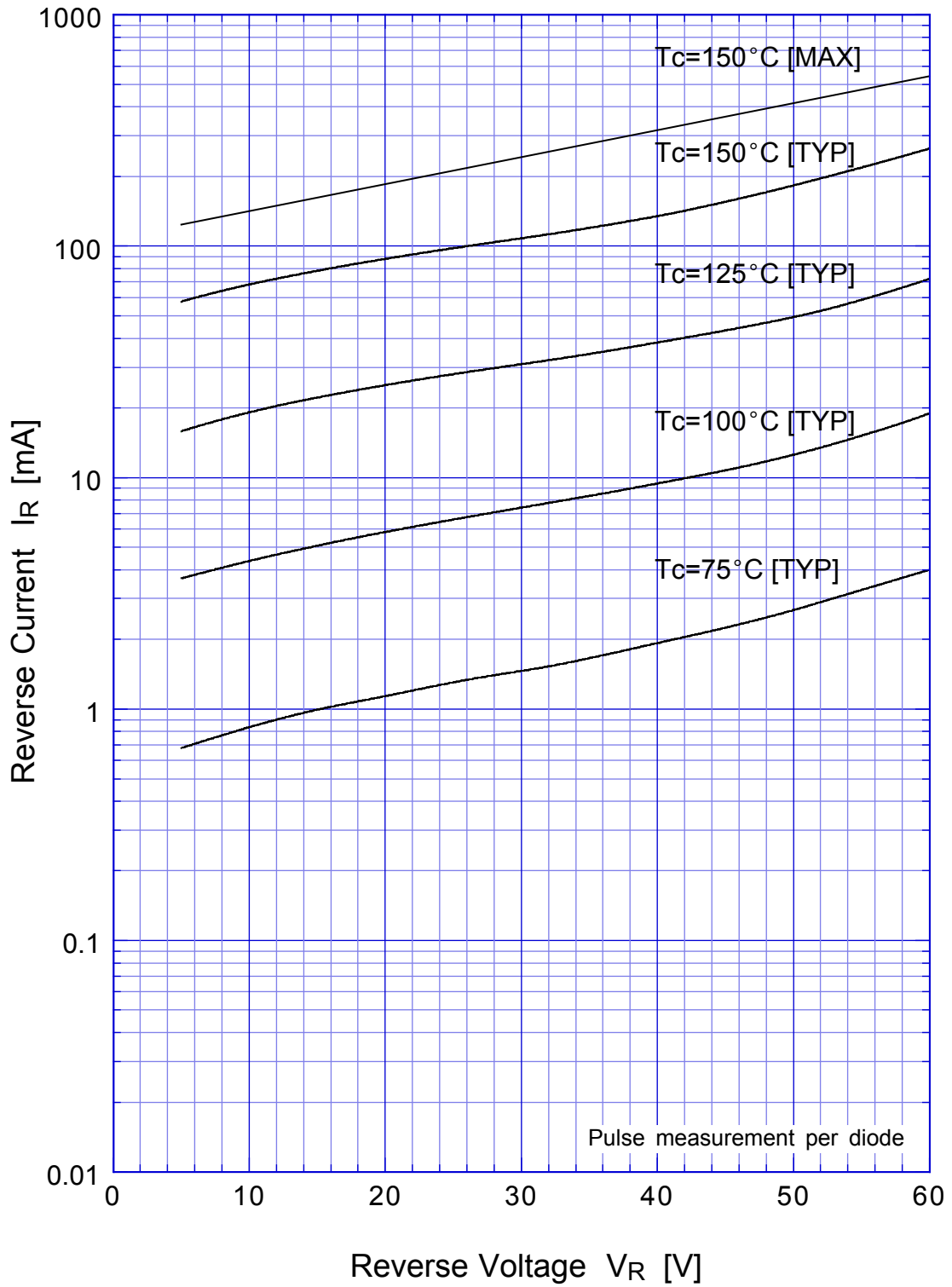

D25SC6MR Reverse Power Dissipation

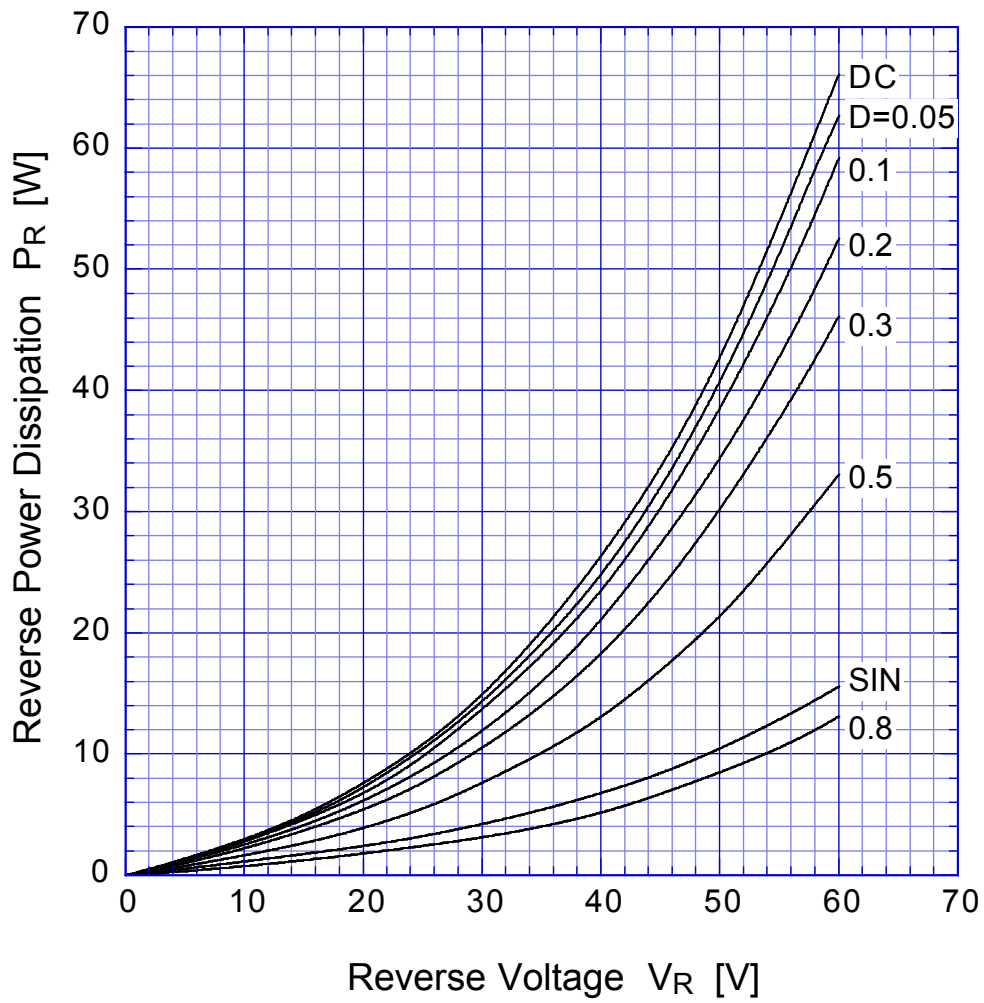

$T_j = 150^\circ\text{C}$

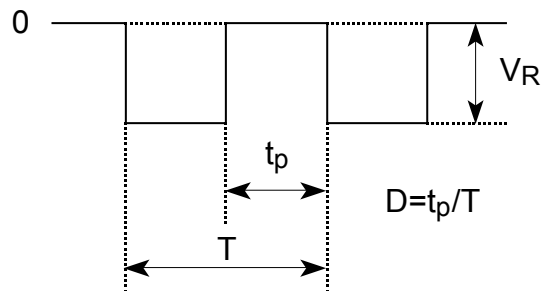

D25SC6MR Forward Power Dissipation

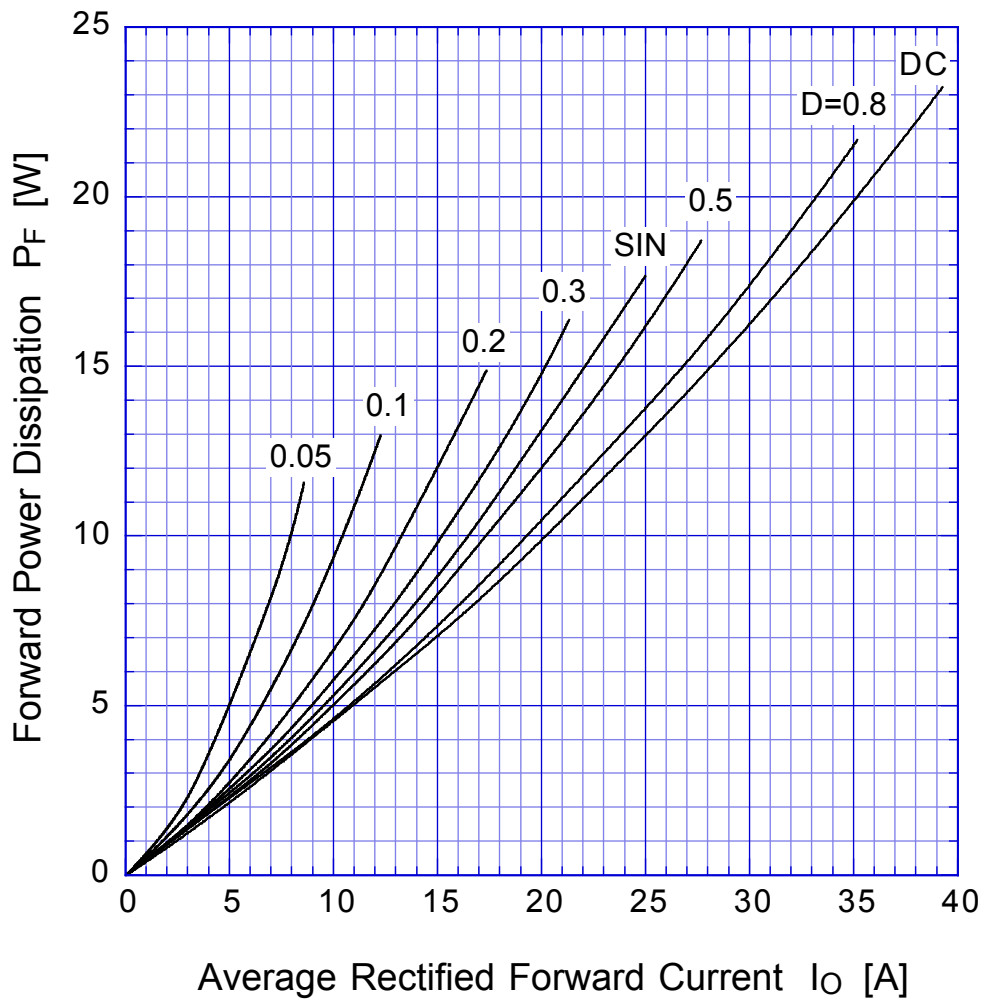

$T_j = 150^\circ\text{C}$

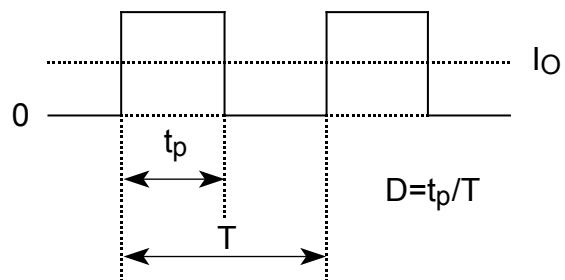

D25SC6MR

Derating Curve

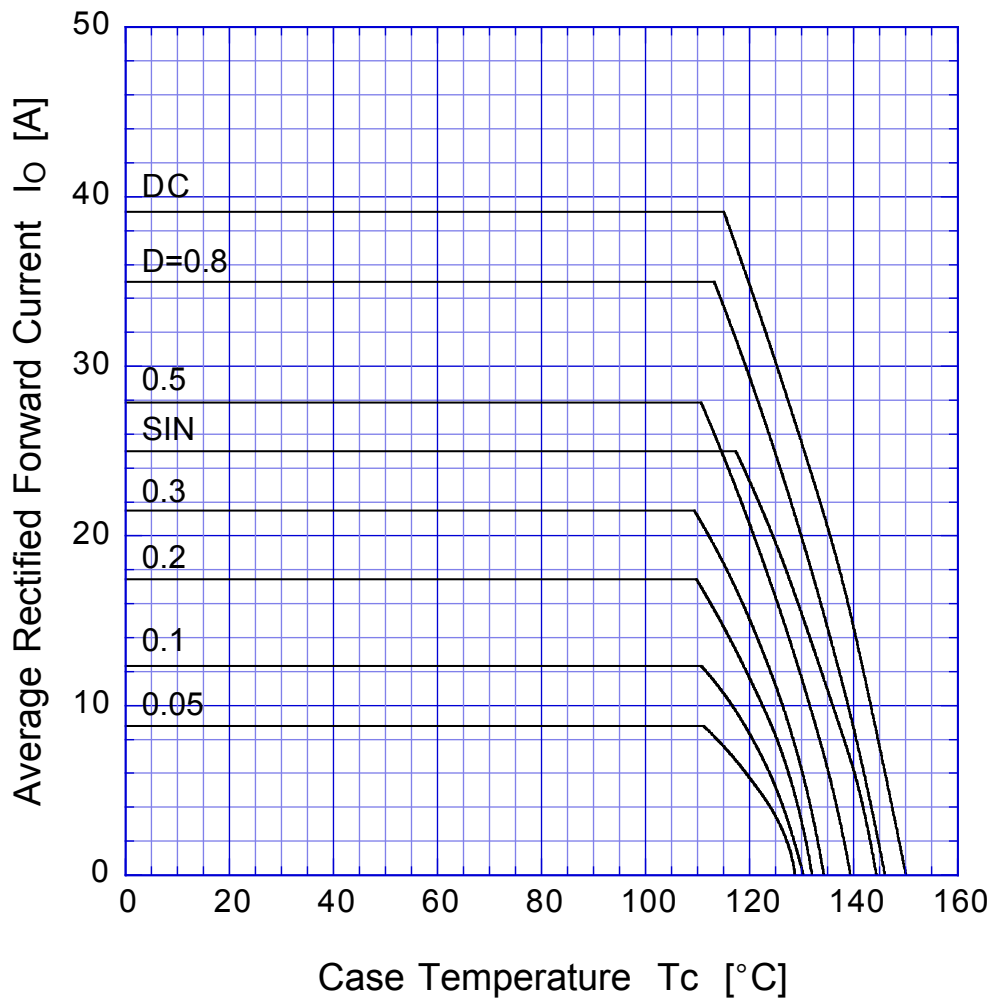

$V_R = 30V$

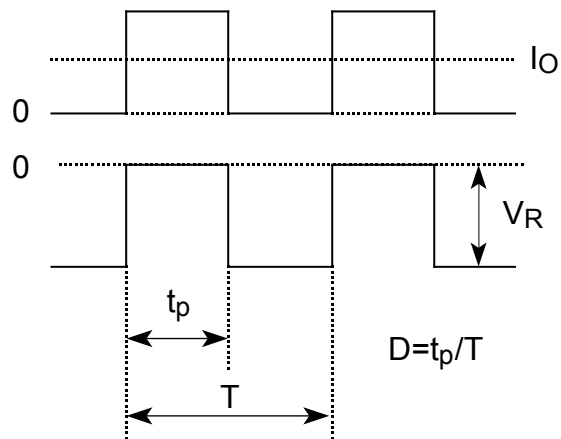

D25SC6MR Peak Surge Forward Capability

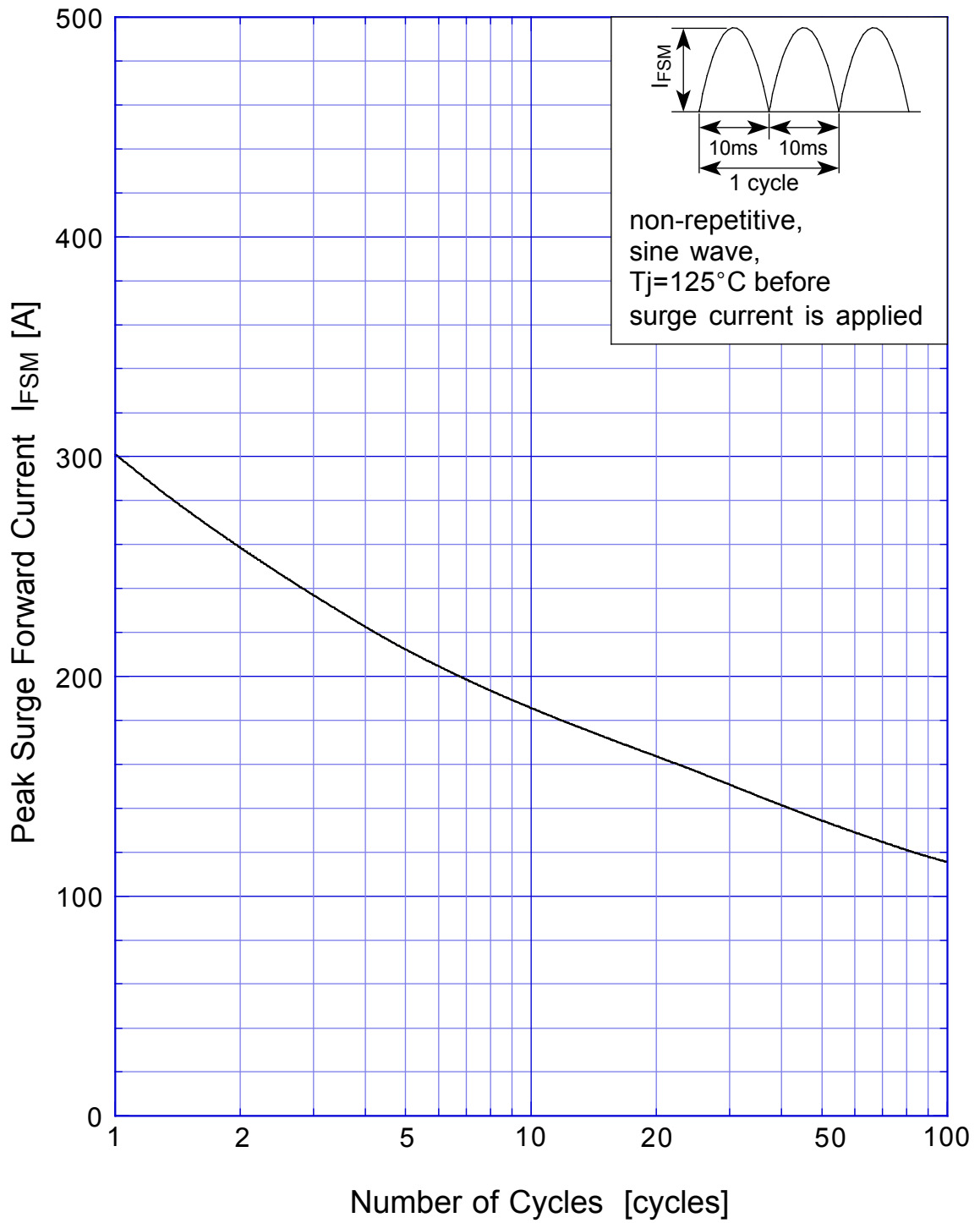

SBD Repetitive Surge Reverse Power Derating Curve

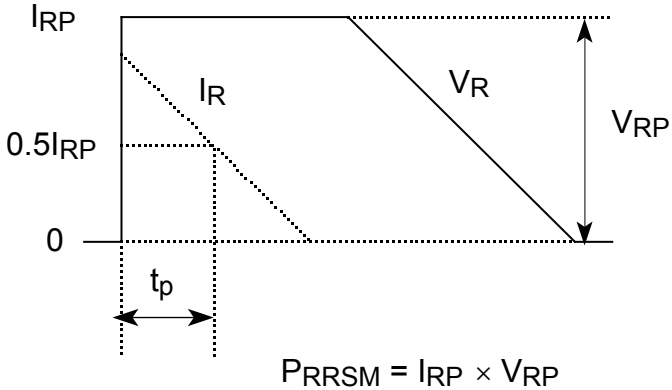
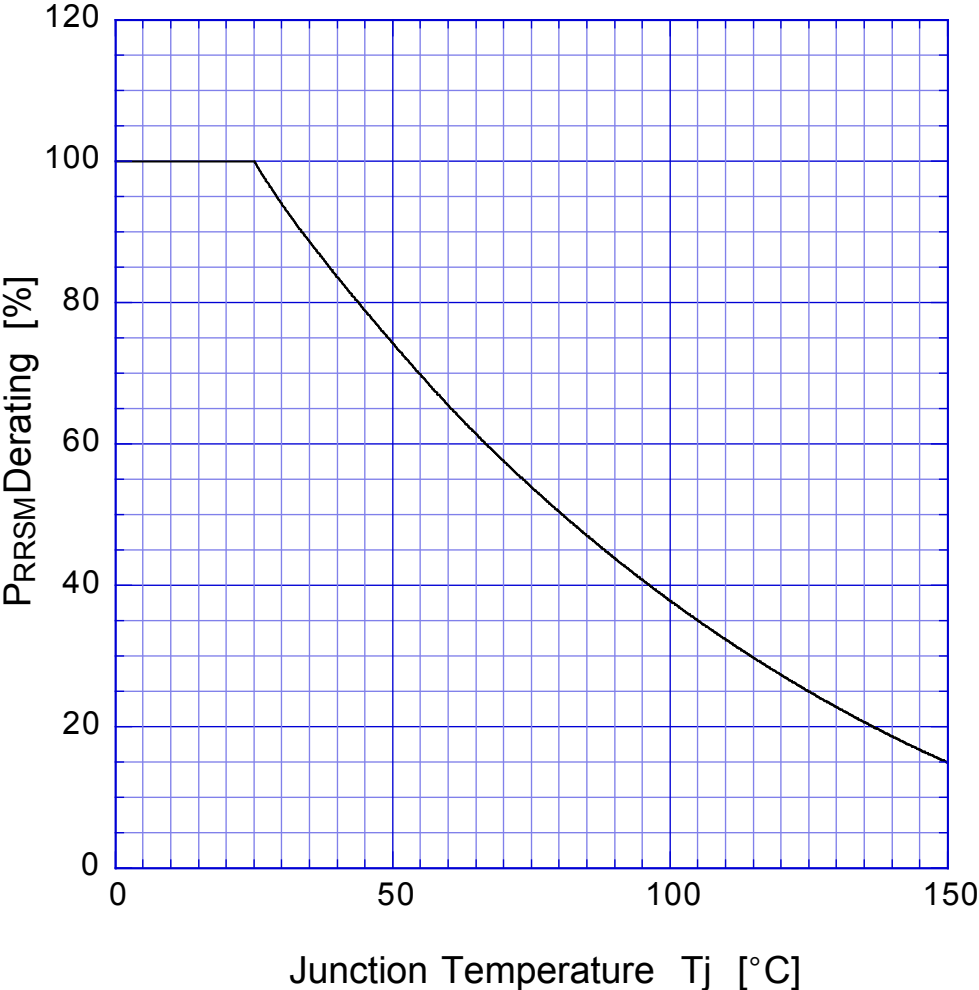

SBD

Repetitive Surge Reverse Power Capability

