

SHINDENGEN

Schottky Rectifiers (SBD)

Dual

DF25SC6M

60V 25A

FEATURES

- SMT
- Tj150
- P_{RRSM} avalanche guaranteed
- High current capacity with Small Package

APPLICATION

- Switching power supply
- DC/DC converter
- Home Appliances, Office Equipment
- Telecommunication

OUTLINE DIMENSIONS

Case : STO-220

Unit : mm

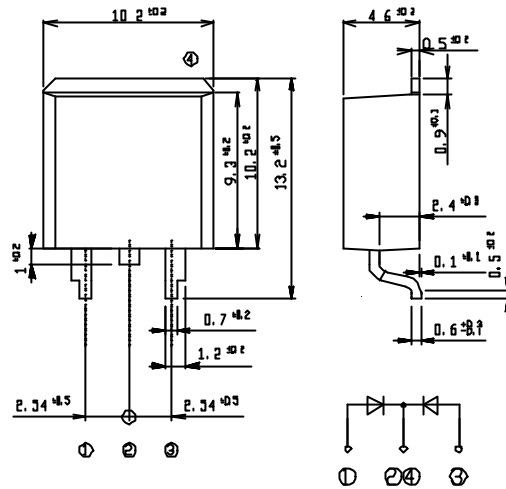

RATINGS

Absolute Maximum Ratings (If not specified T_c=25)

Item	Symbol	Conditions	Ratings	Unit
Storage Temperature	T _{stg}		-40 ~ 150	
Operating Junction Temperature	T _j		150	
Maximum Reverse Voltage	V _{RM}		60	V
Repetitive Peak Surge Reverse Voltage	V _{RRSM}	Pulse width 0.5ms, duty 1/40	65	V
Average Rectified Forward Current	I _O	50Hz sine wave, R-load, Rating for each diode I _O /2, T _c =115	25	A
Peak Surge Forward Current	I _{FSM}	50Hz sine wave, Non-repetitive 1 cycle peak value, T _j =25	300	A
Repetitive Peak Surge Reverse Power	P _{RRSM}	Pulse width 10 μ s, Rating of per diode, T _i = 25	660	W

Electrical Characteristics (If not specified T_c=25)

Item	Symbol	Conditions	Ratings	Unit
Forward Voltage	V _F	I _F =12.5A, Pulse measurement, Rating of per diode	Max.0.58	V
Reverse Current	I _R	V _R =V _{RM} , Pulse measurement, Rating of per diode	Max.10	mA
Junction Capacitance	C _j	f=1MHz, V _R =10V, Rating of per diode	Typ.490	pF
Thermal Resistance	θ _{JC}	junction to case	Max.1.6	/W

DF25SC6M Forward Voltage

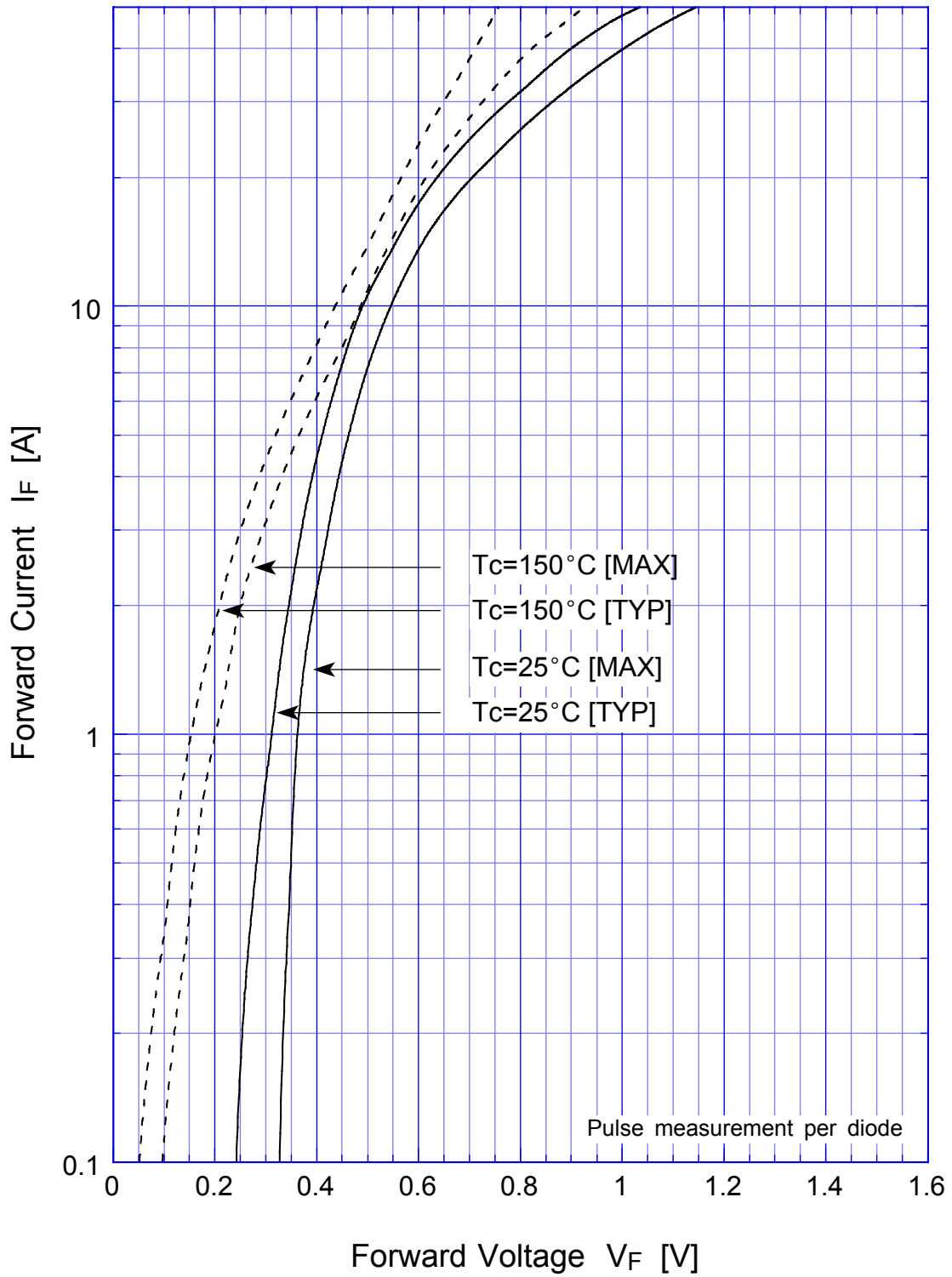

DF25SC6M Junction Capacitance

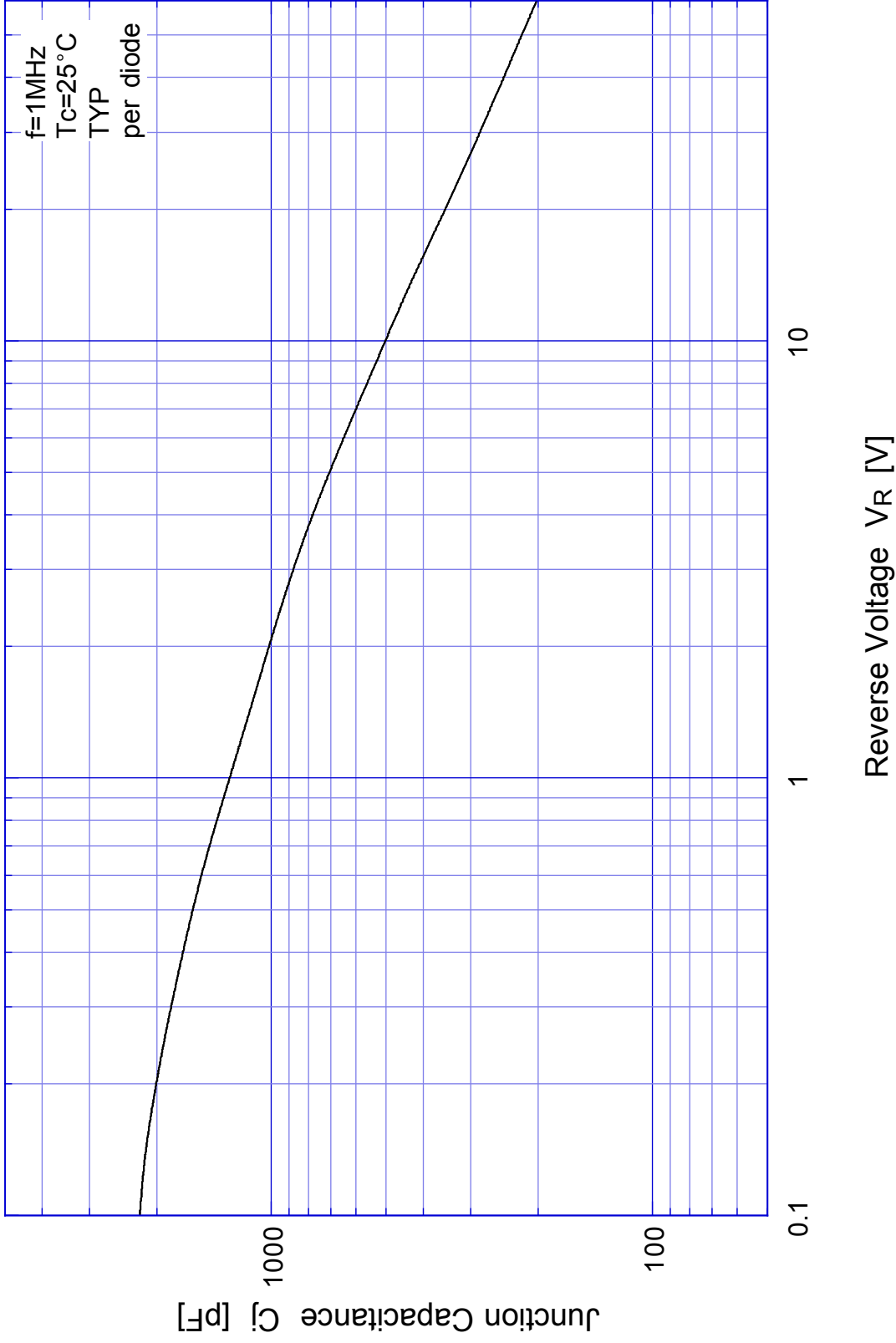

DF25SC6M Reverse Current

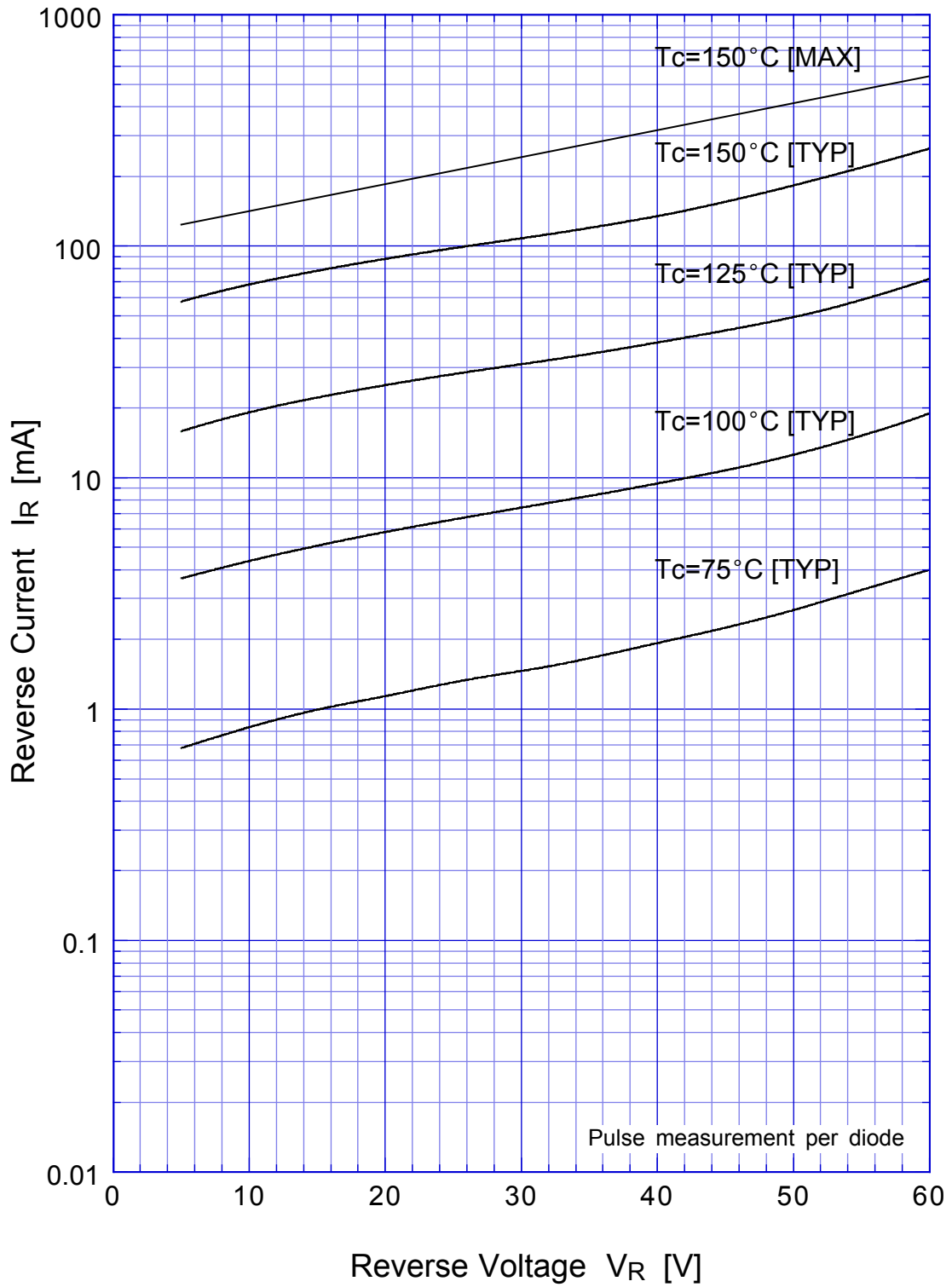

DF25SC6M Reverse Power Dissipation

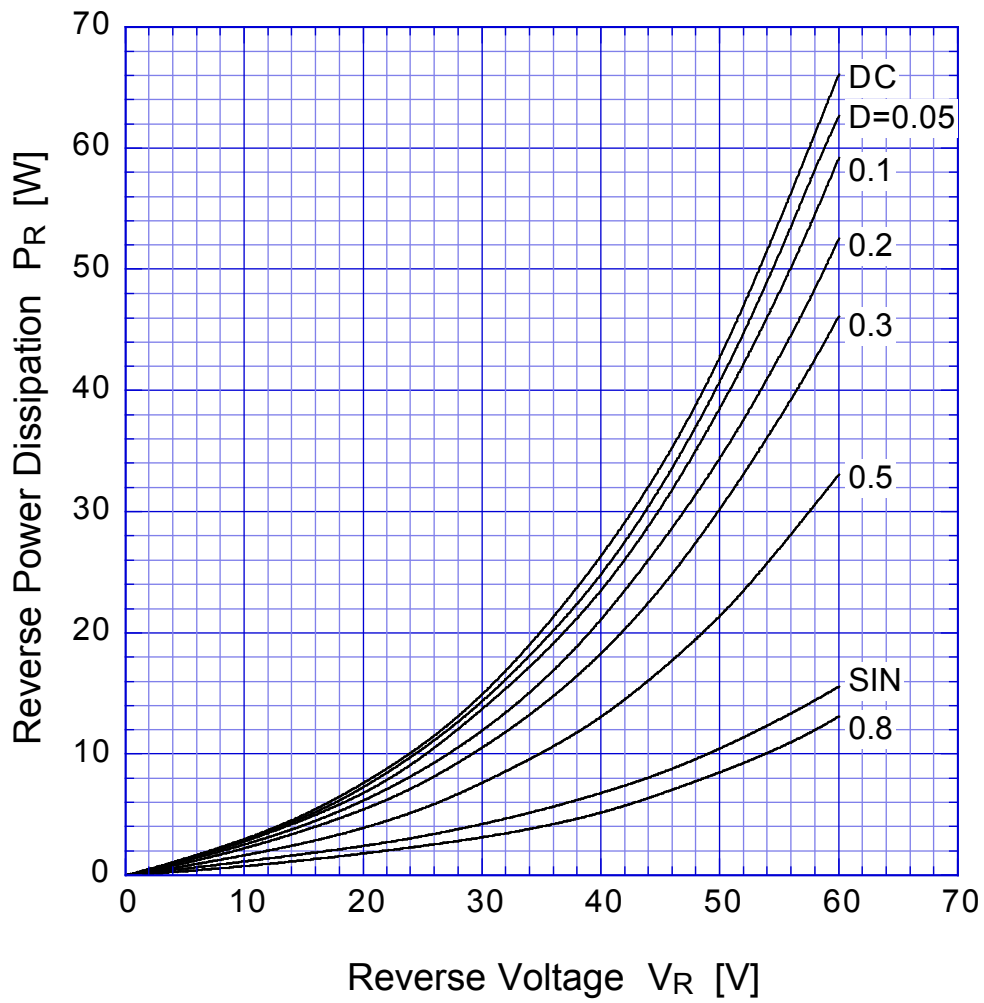

$T_j = 150^\circ\text{C}$

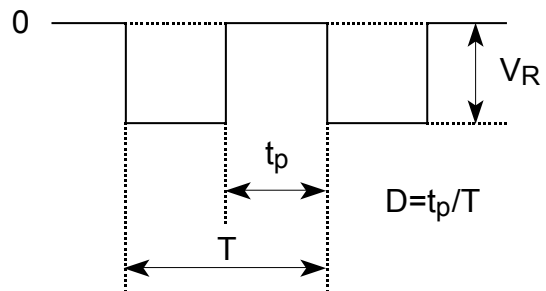

DF25SC6M Forward Power Dissipation

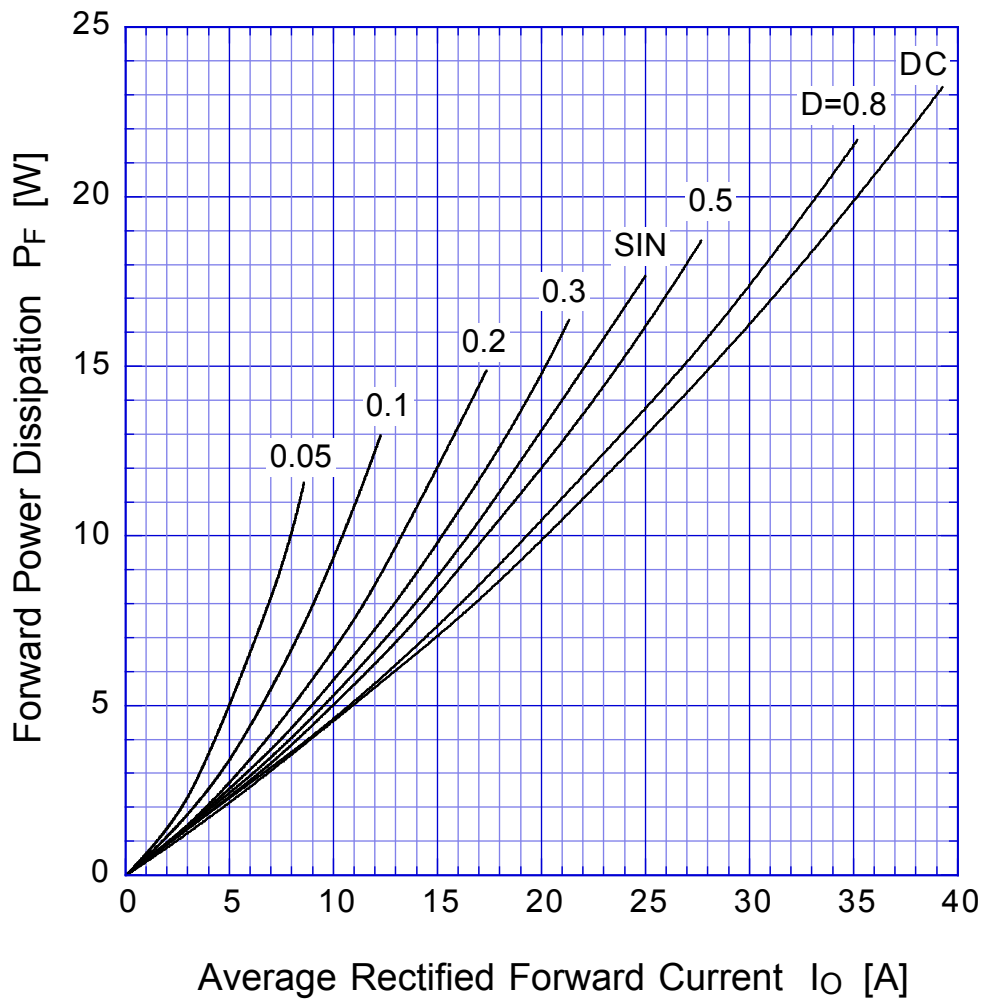

$T_j = 150^\circ\text{C}$



DF25SC6M

Derating Curve

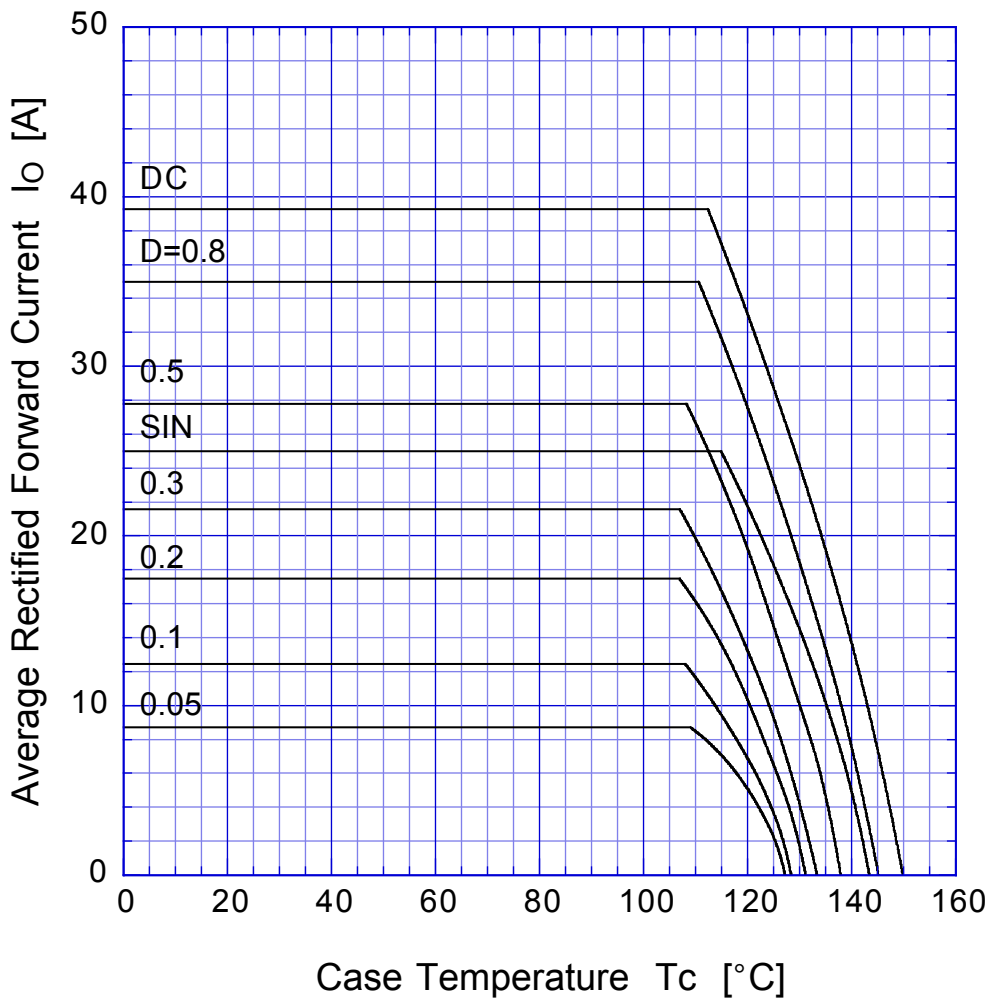

$V_R = 30V$

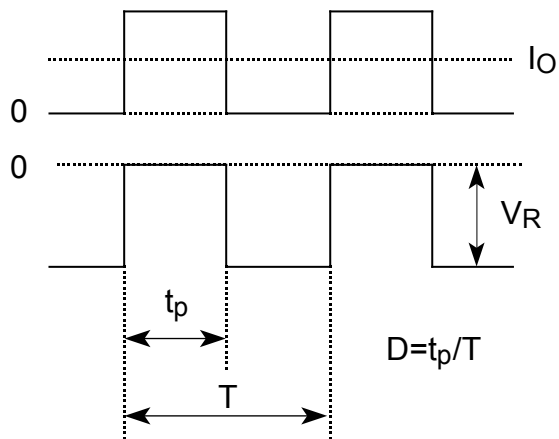

DF25SC6M Peak Surge Forward Capability

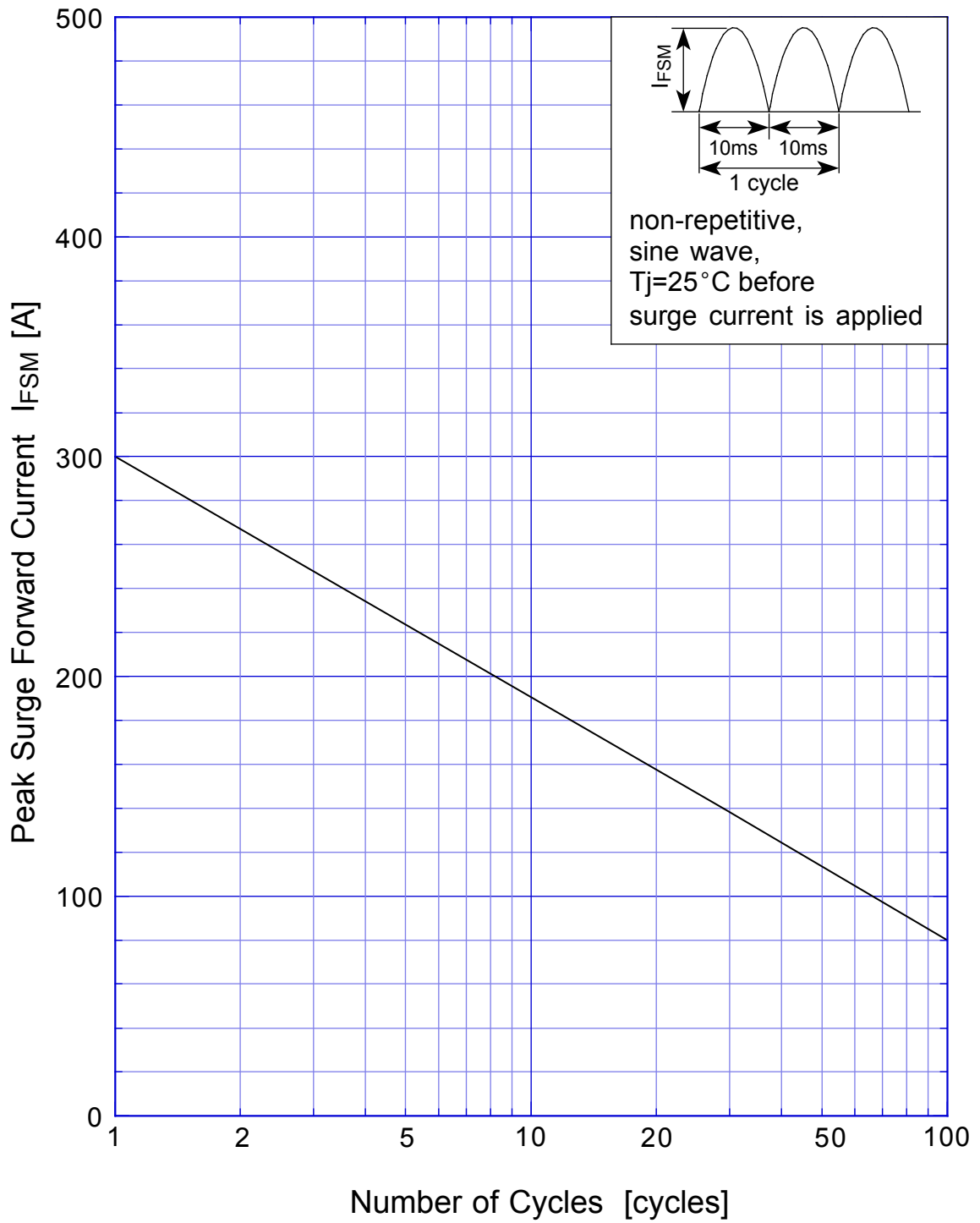

SBD Repetitive Surge Reverse Power Derating Curve



SBD

Repetitive Surge Reverse Power Capability

