

SHINDENGEN

Schottky Rectifiers (SBD)

Dual

DF40SC4

40V 40A

FEATURE

- SMT
- Tj150
- P_{RRSM} avalanche guarantee
- High current capacity with Small Package

APPLICATION

- Switching power supply
- DC/DC converter
- Home Appliances, Office Equipment
- Telecommunication

OUTLINE DIMENSIONS

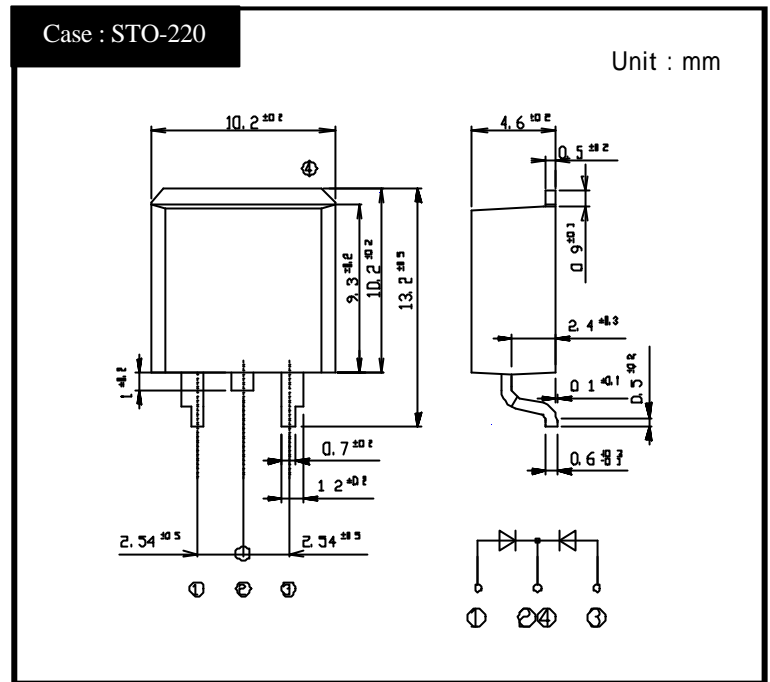

RATINGS

Absolute Maximum Ratings (If not specified Tc=25)

Item	Symbol	Conditions	Ratings	Unit
Storage Temperature	T _{stg}		-55 ~ 150	
Operating Junction Temperature	T _j		150	
Maximum Reverse Voltage	V _{RM}		40	V
Repetitive Peak Surge Reverse Voltage	V _{RRSM}	Pulse width 0.5ms, duty 1/40	45	V
Average Rectified Forward Current	I _O	50Hz sine wave, R-load, Rating for each diode I _O /2, T _c =106	40	A
Peak Surge Forward Current	I _{FSM}	50Hz sine wave, Non-repetitive 1 cycle peak value, T _j =25	350	A
Repetitive Peak Surge Reverse Power	P _{RRSM}	Pulse width 10 μs, Rating of per diode, T _j =25	1000	W

Electrical Characteristics (If not specified Tc=25)

Item	Symbol	Conditions	Ratings	Unit
Forward Voltage	V _F	I _F =20A, Pulse measurement, Rating of per diode	Max.0.55	V
Reverse Current	I _R	V _R =V _{RM} , Pulse measurement, Rating of per diode	Max.14	mA
Junction Capacitance	C _j	f=1MHz, V _R =10V, Rating of per diode	Typ.860	pF
Thermal Resistance	θ _{jc}	junction to case	Max.1.5	/W

DF40SC4

Forward Voltage

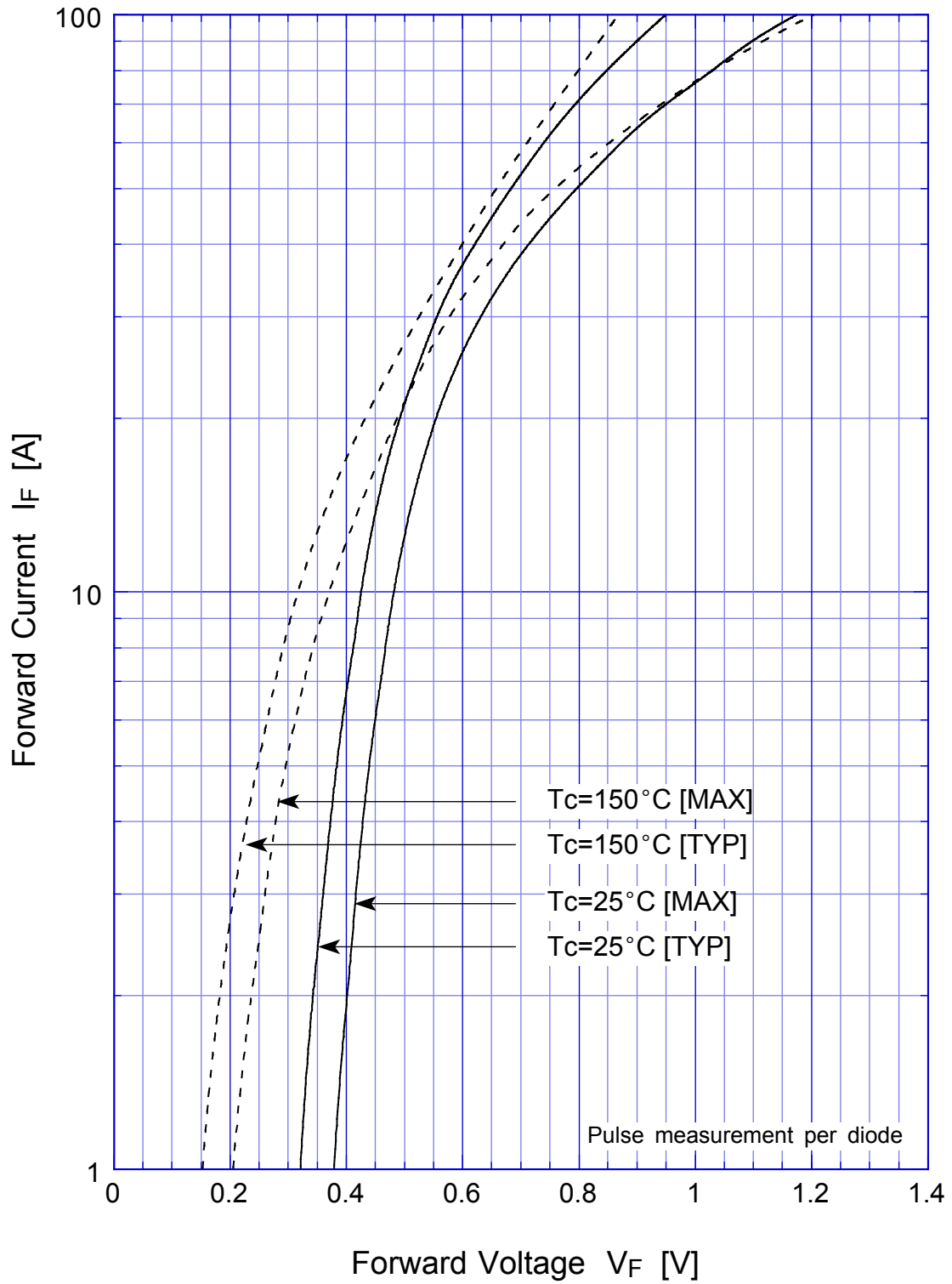

DF40SC4 Junction Capacitance

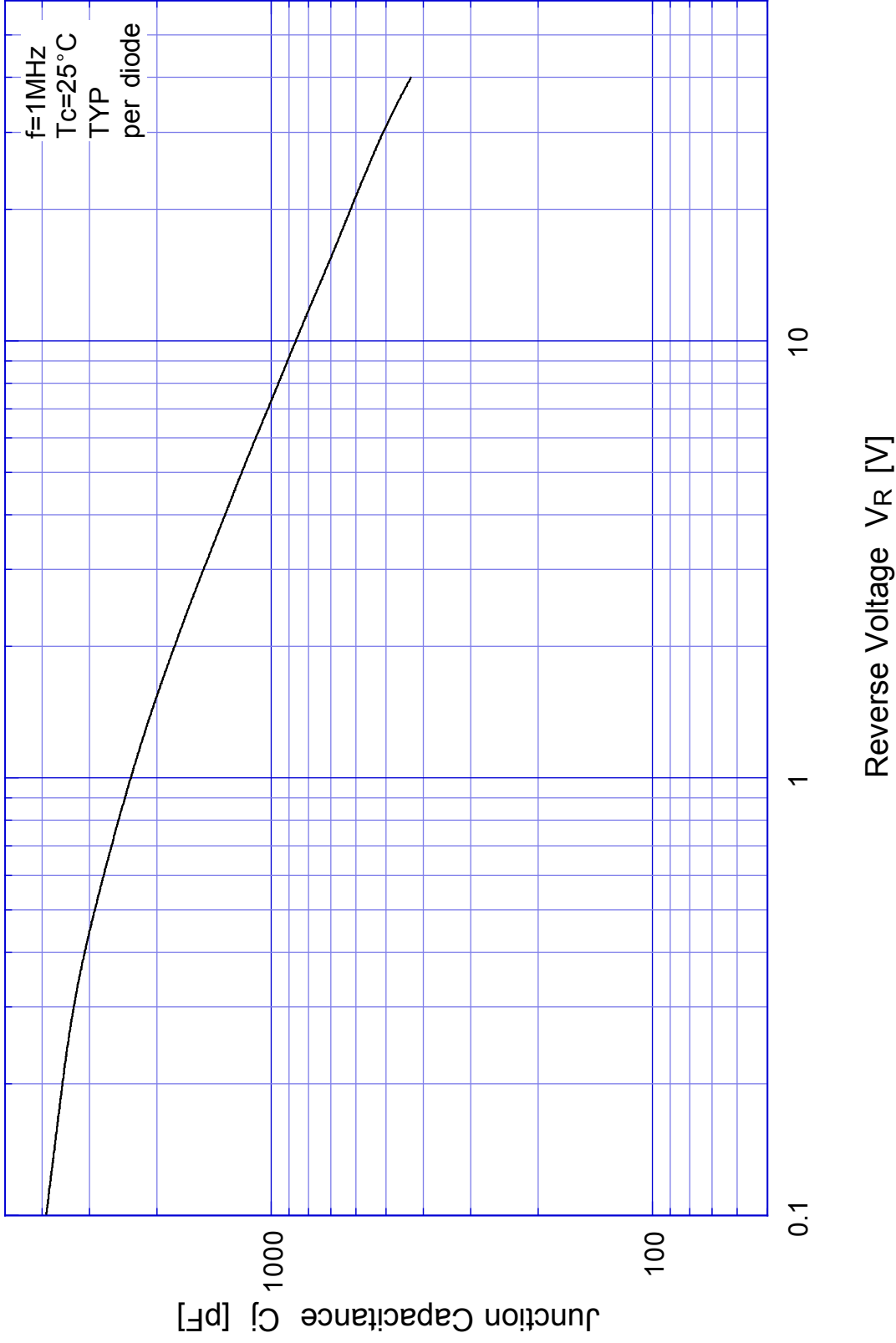

DF40SC4 Reverse Current

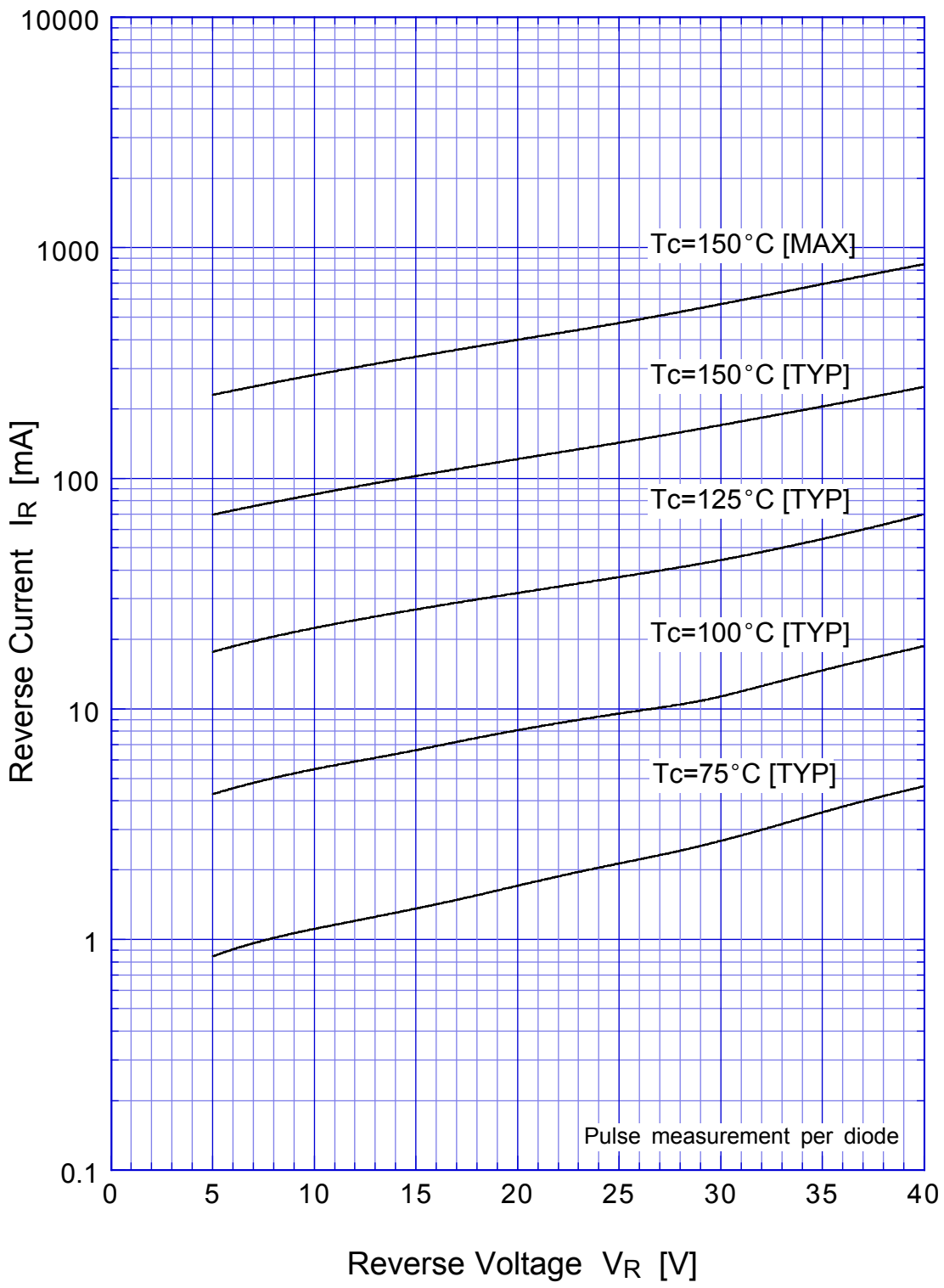

DF40SC4 Reverse Power Dissipation

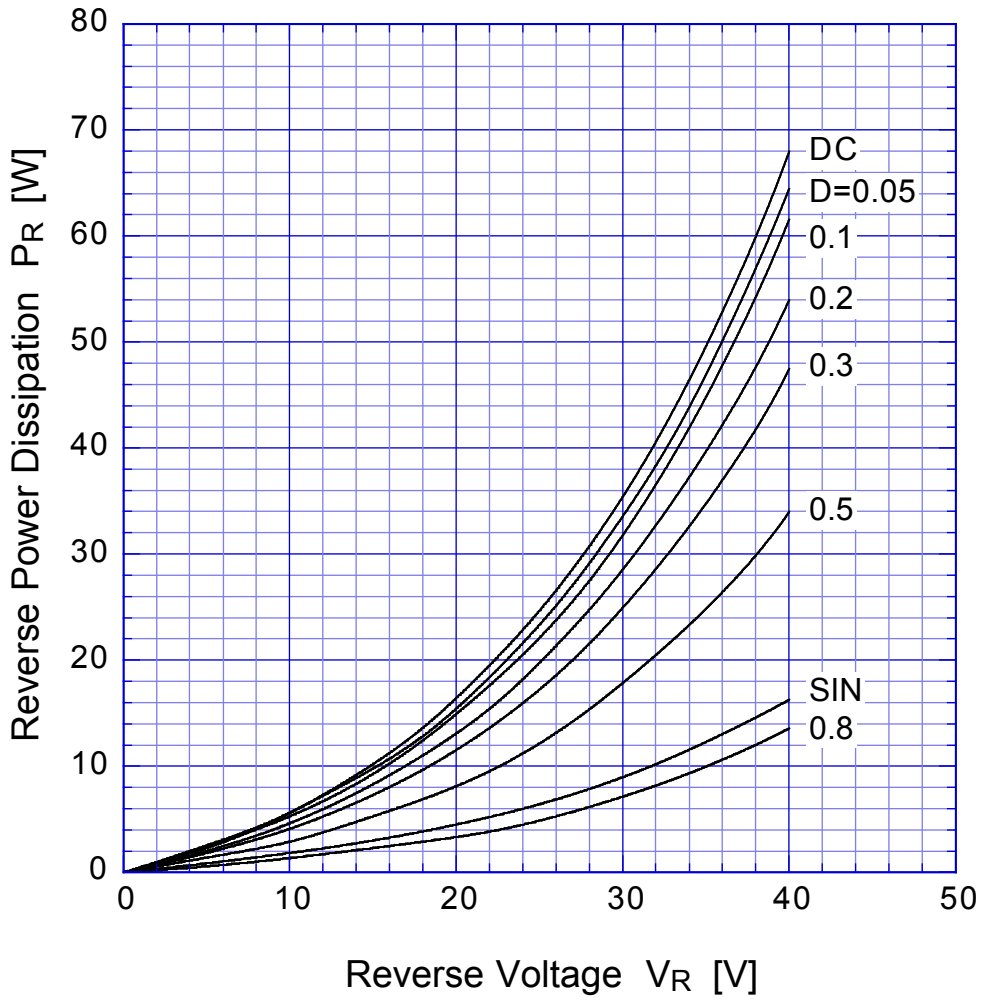

$T_j = 150^\circ\text{C}$

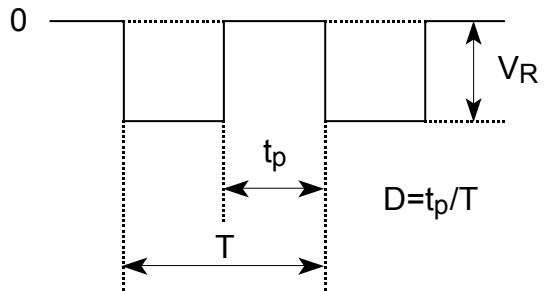

DF40SC4 Forward Power Dissipation

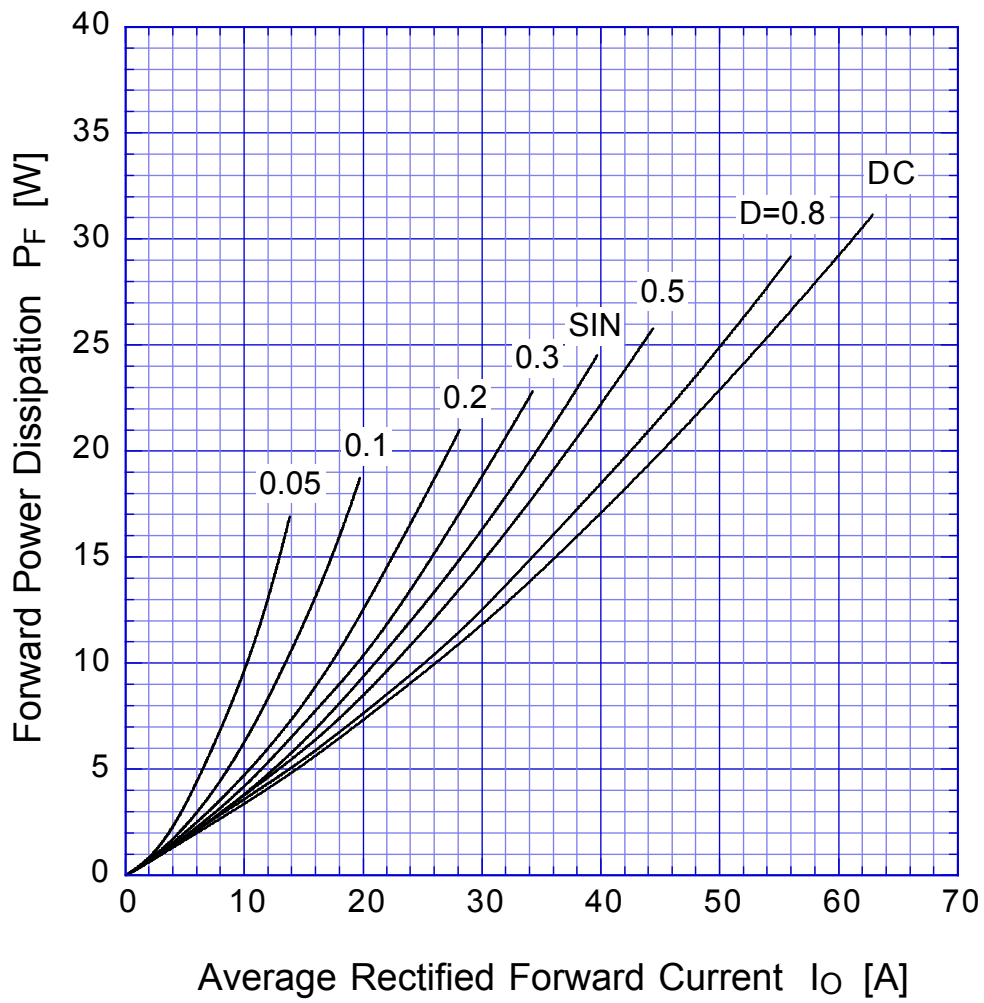

$T_j = 150^\circ\text{C}$

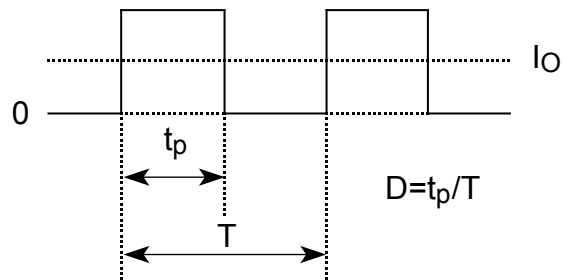

DF40SC4

Derating Curve

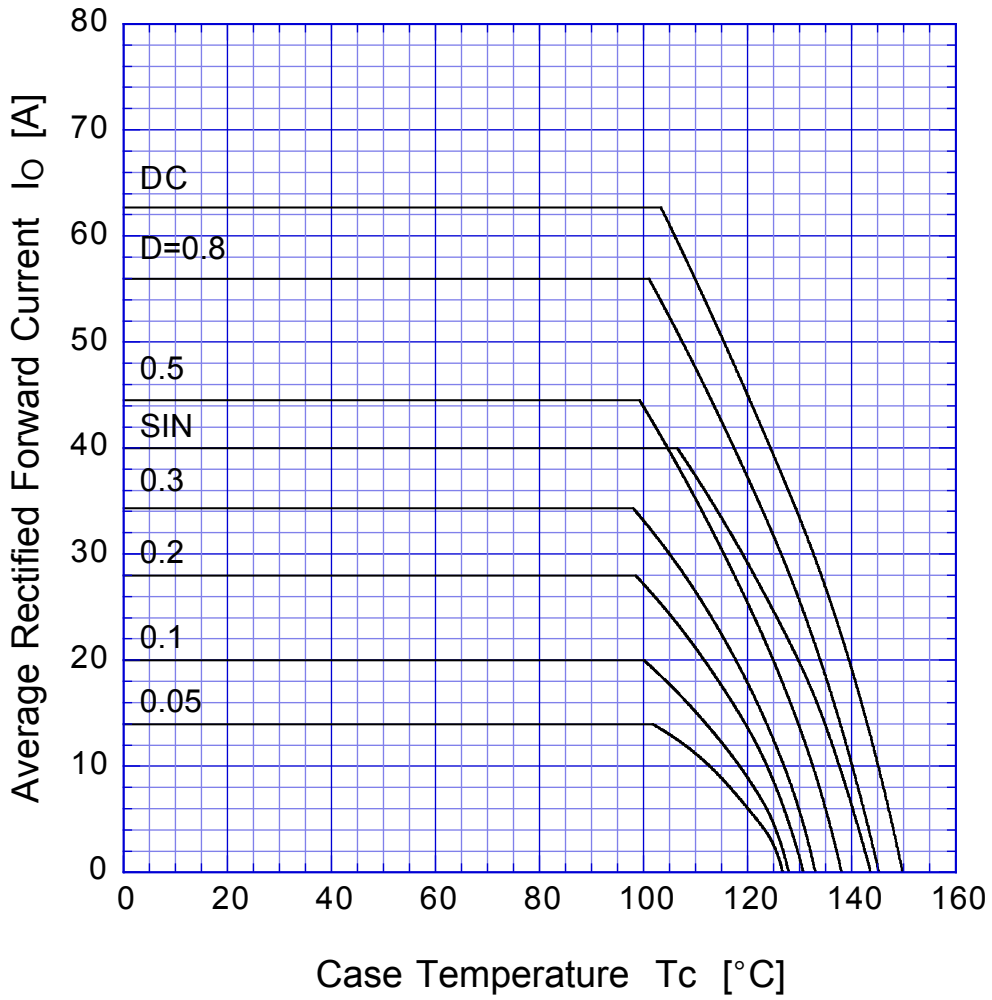

$V_R = 20V$

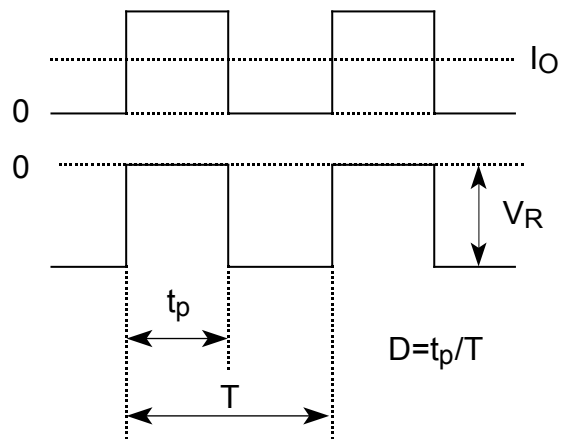

DF40SC4 Peak Surge Forward Capability

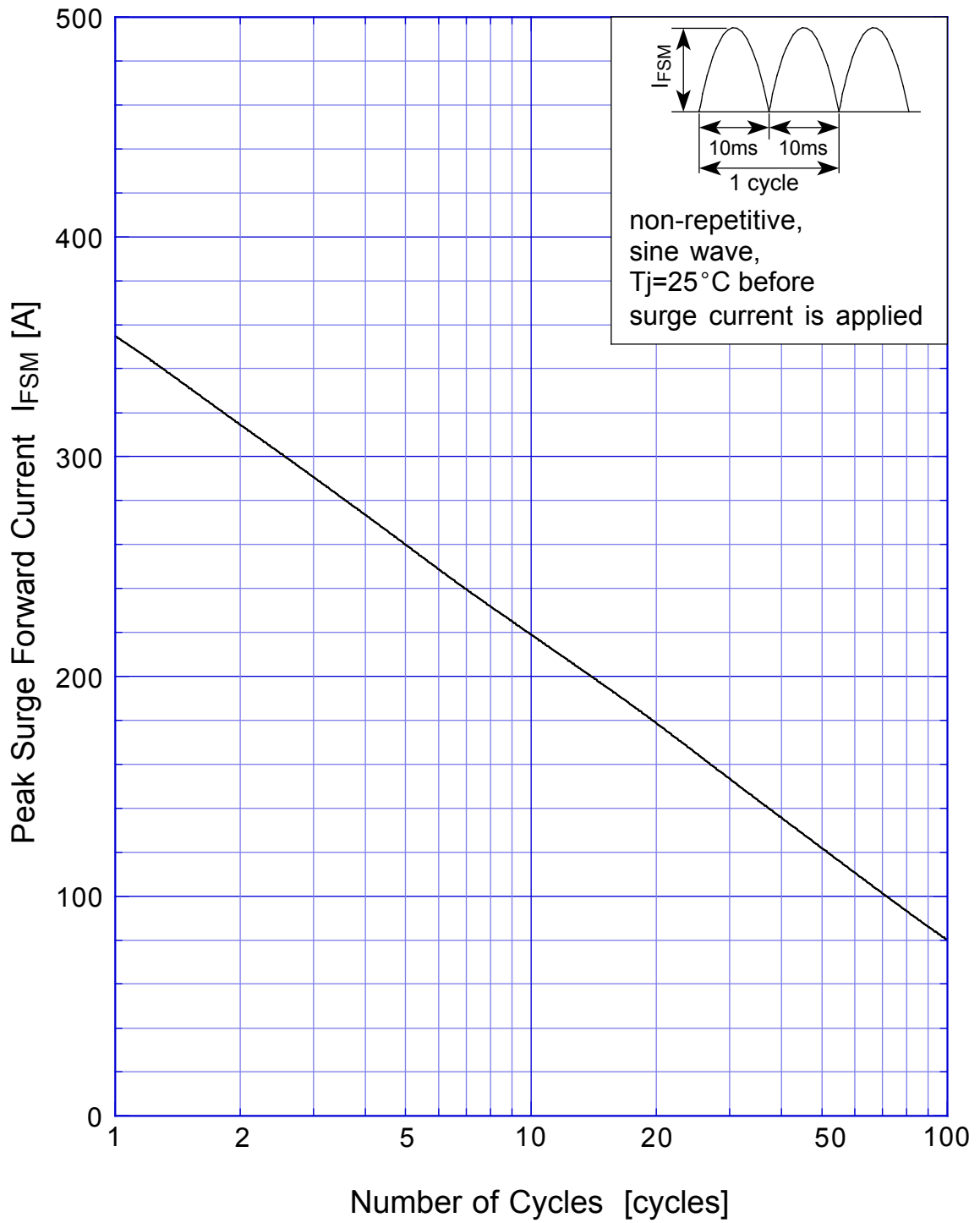

SBD Repetitive Surge Reverse Power Derating Curve

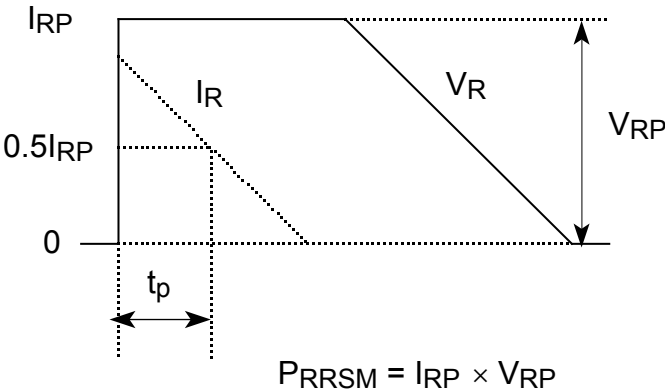
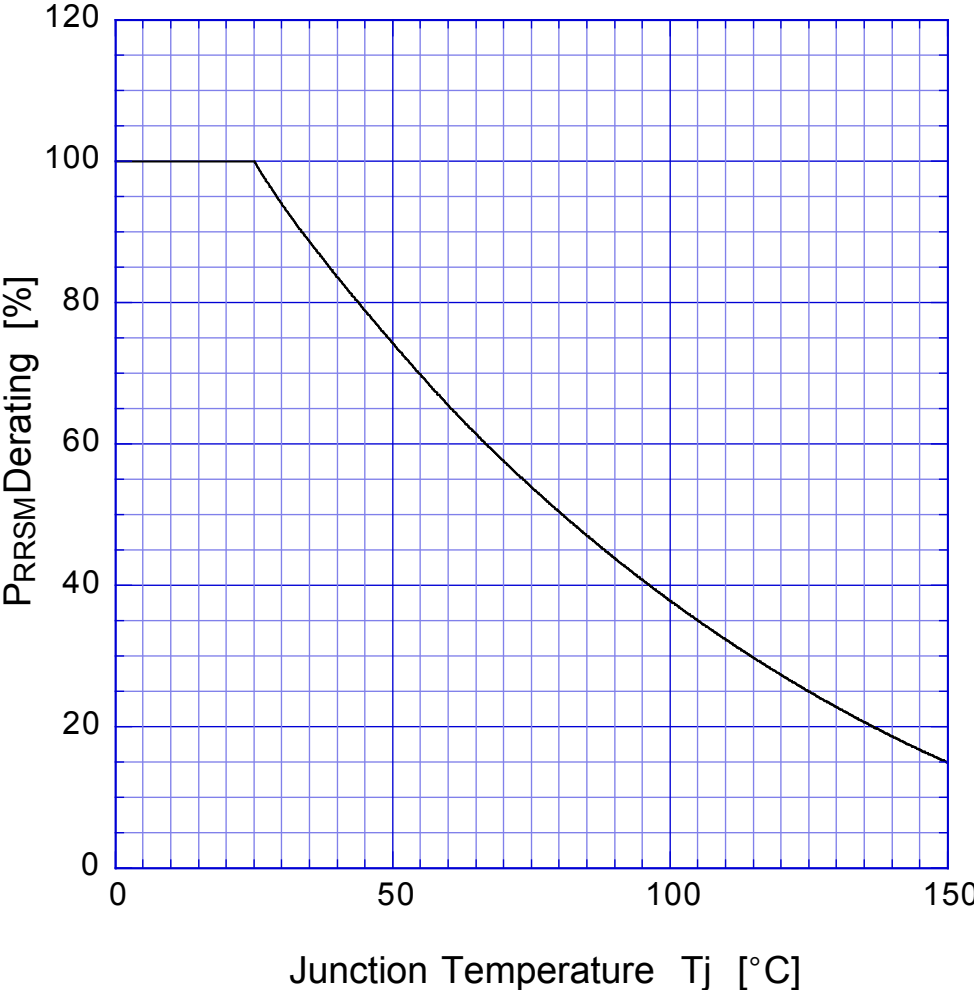

SBD

Repetitive Surge Reverse Power Capability

