

SHINDENGEN

Schottky Rectifiers (SBD)

Single

D2FS6

60V 1.5A

FEATURES

- Small SMT
- Tj150
- P_{RRSM} avalanche guaranteed

APPLICATION

- Switching power supply
- DC/DC converter
- Home Appliances, Office Equipment
- Telecommunication

OUTLINE DIMENSIONS

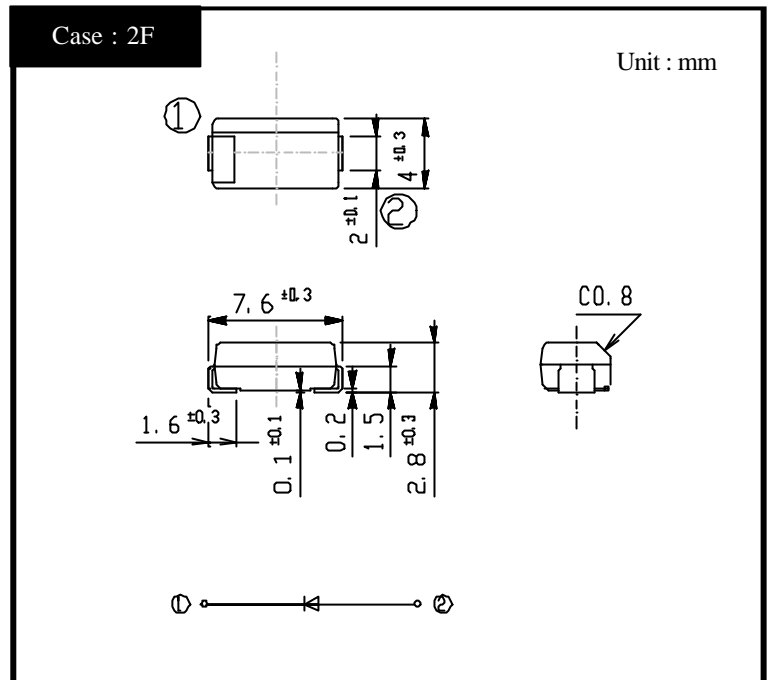

RATINGS

Absolute Maximum Ratings (If not specified Tl=25)

Item	Symbol	Conditions	Ratings	Unit
Storage Temperature	T _{stg}		-40 ~ 150	
Operating Junction Temperature	T _j		150	
Maximum Reverse Voltage	V _{RM}		60	V
Repetitive Peak Surge Reverse Voltage	V _{RRSM}	Pulse width 0.5ms, duty 1/40	65	V
Average Rectified Forward Current	I _O	50Hz sine wave, R-load Ta=31 On alumina substrate	1.5	A
		50Hz sine wave, R-load Ta=26 On glass-epoxy substrate	1.1	
Peak Surge Forward Current	I _{FSM}	50Hz sine wave, Non-repetitive 1 cycle peak value, Tj=25	60	A
Repetitive Peak Surge Reverse Power	P _{RRSM}	Pulse width 10 μs, Tj=25	330	W

Electrical Characteristics (If not specified Tl=25)

Item	Symbol	Conditions	Ratings	Unit
Forward Voltage	V _F	I _F =1.5A, Pulse measurement	Max.0.58	V
Reverse Current	I _R	V _R =V _{RM} , Pulse measurement	Max.2	mA
Junction Capacitance	C _j	f=1MHz, V _R =10V	Typ.120	pF
Thermal Resistance	j-l	junction to lead	Max.24	/W
	j-a	junction to ambient On alumina substrate	Max.90	
		junction to ambient On glass-epoxy substrate	Max.126	

D2FS6

Forward Voltage

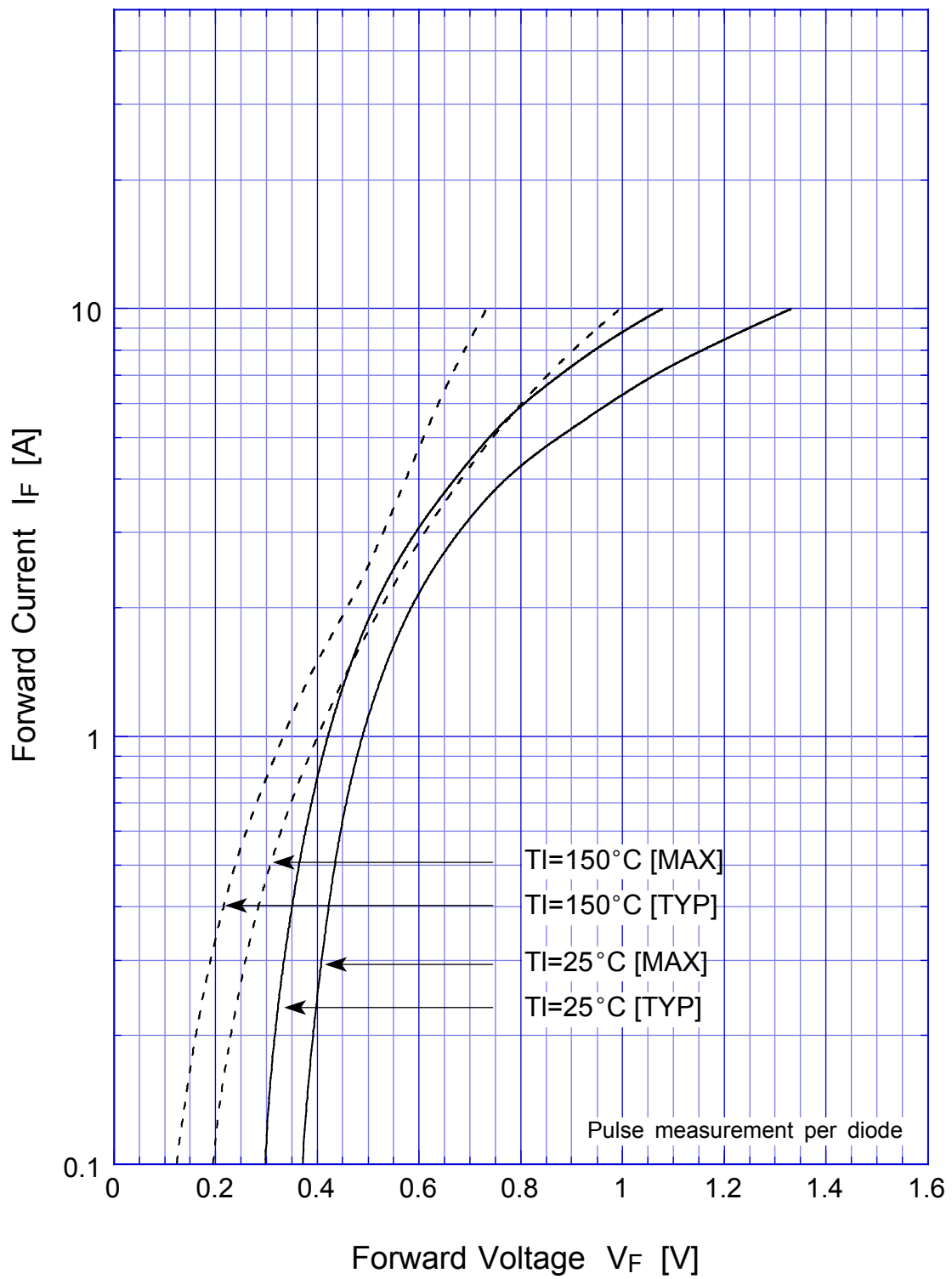

D2FS6

Junction Capacitance

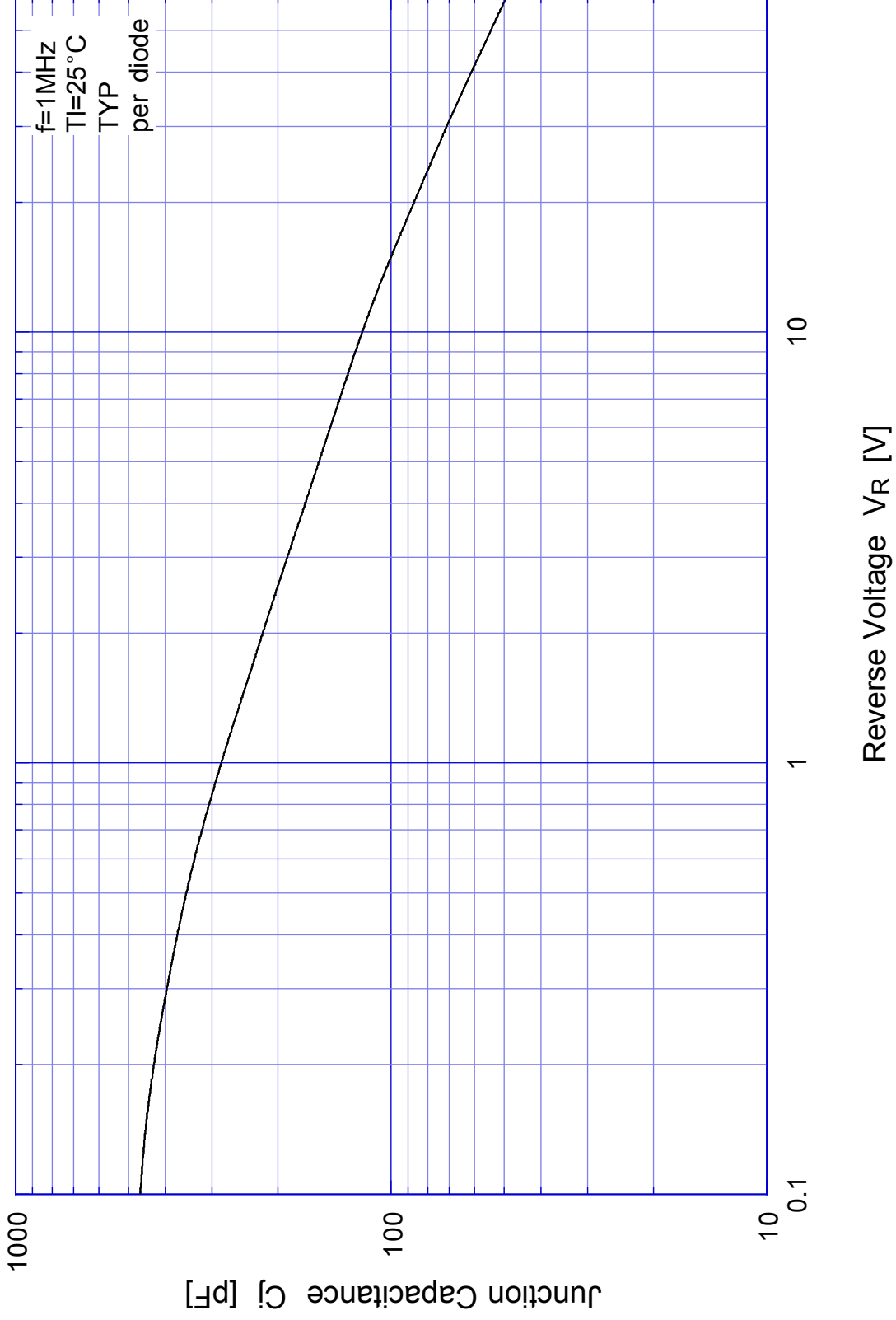

D2FS6

Reverse Current

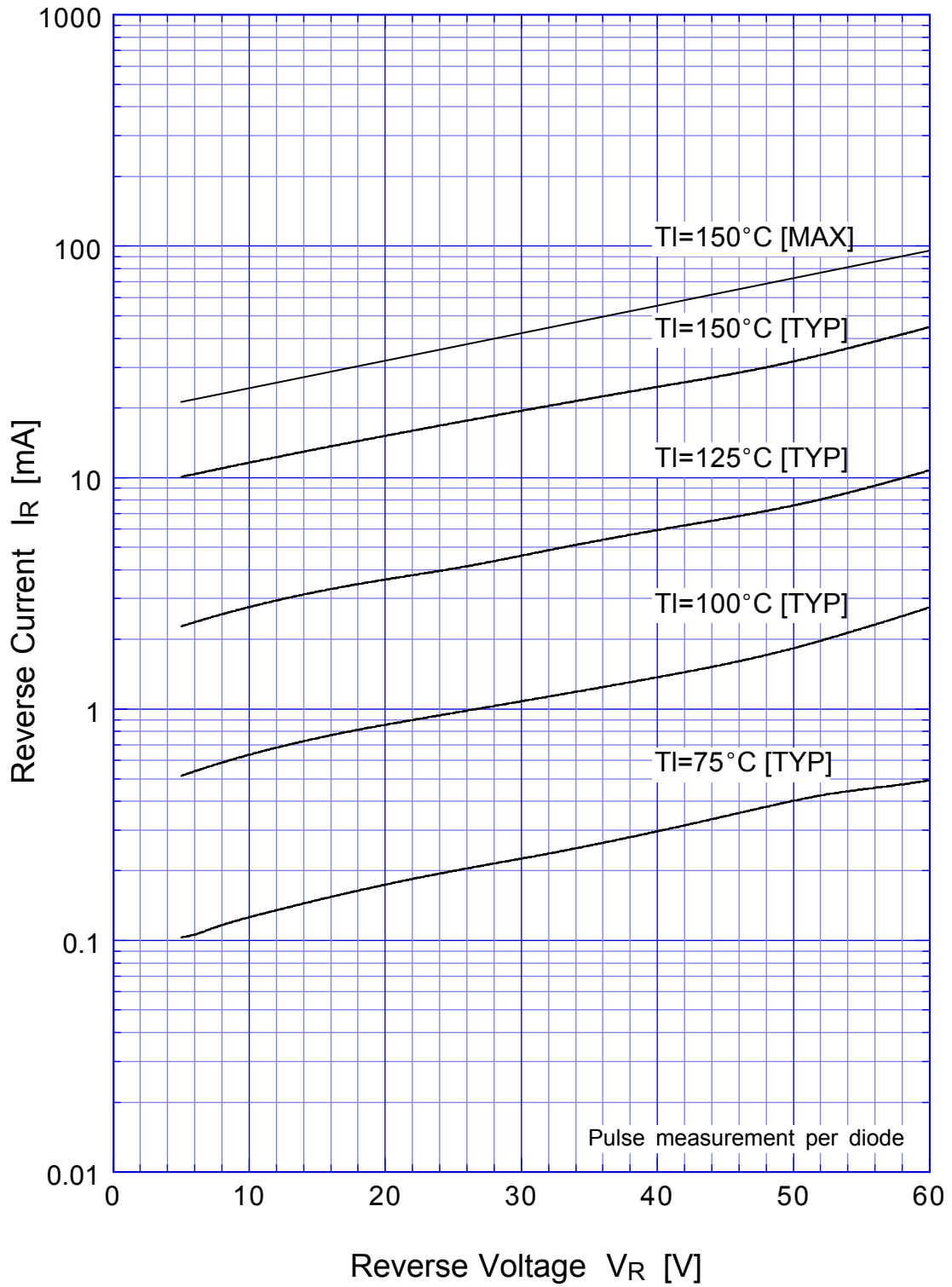

D2FS6

Reverse Power Dissipation

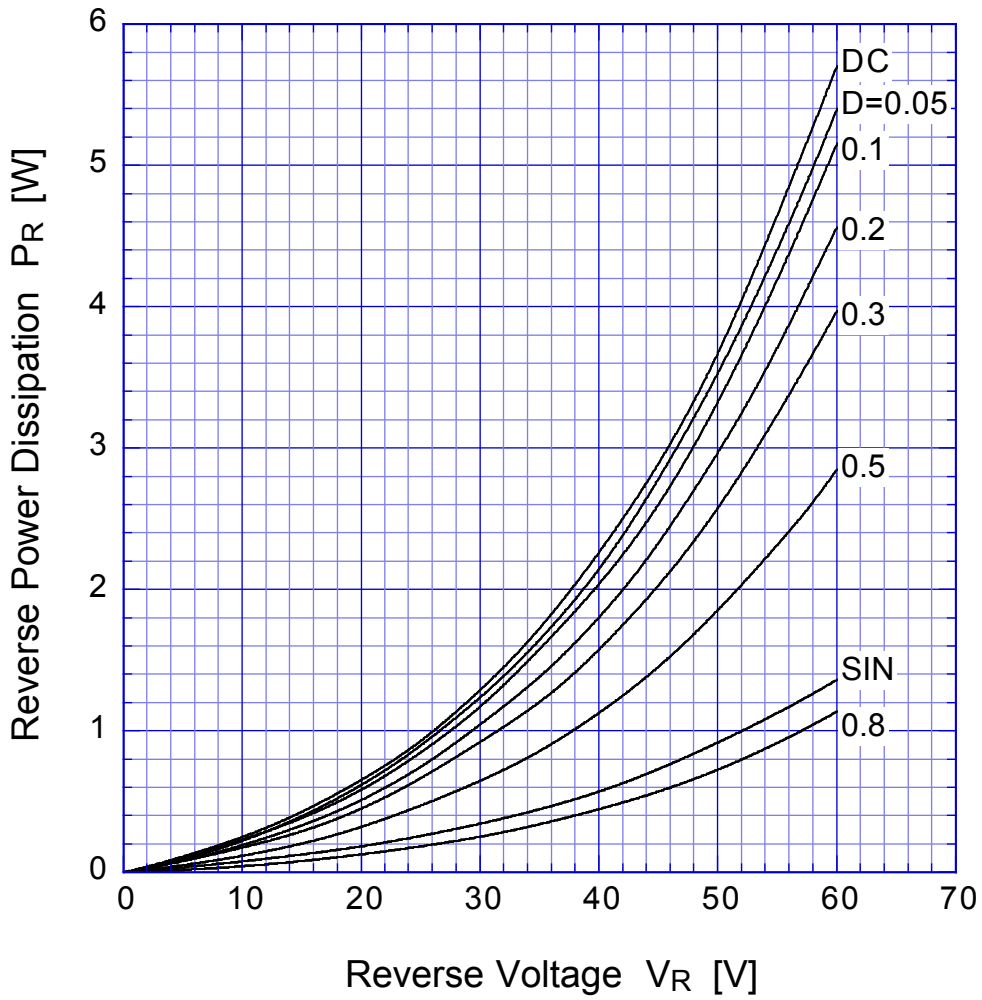

$T_j = 150^\circ\text{C}$

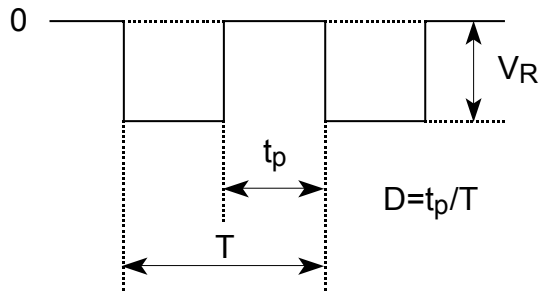

D2FS6

Forward Power Dissipation

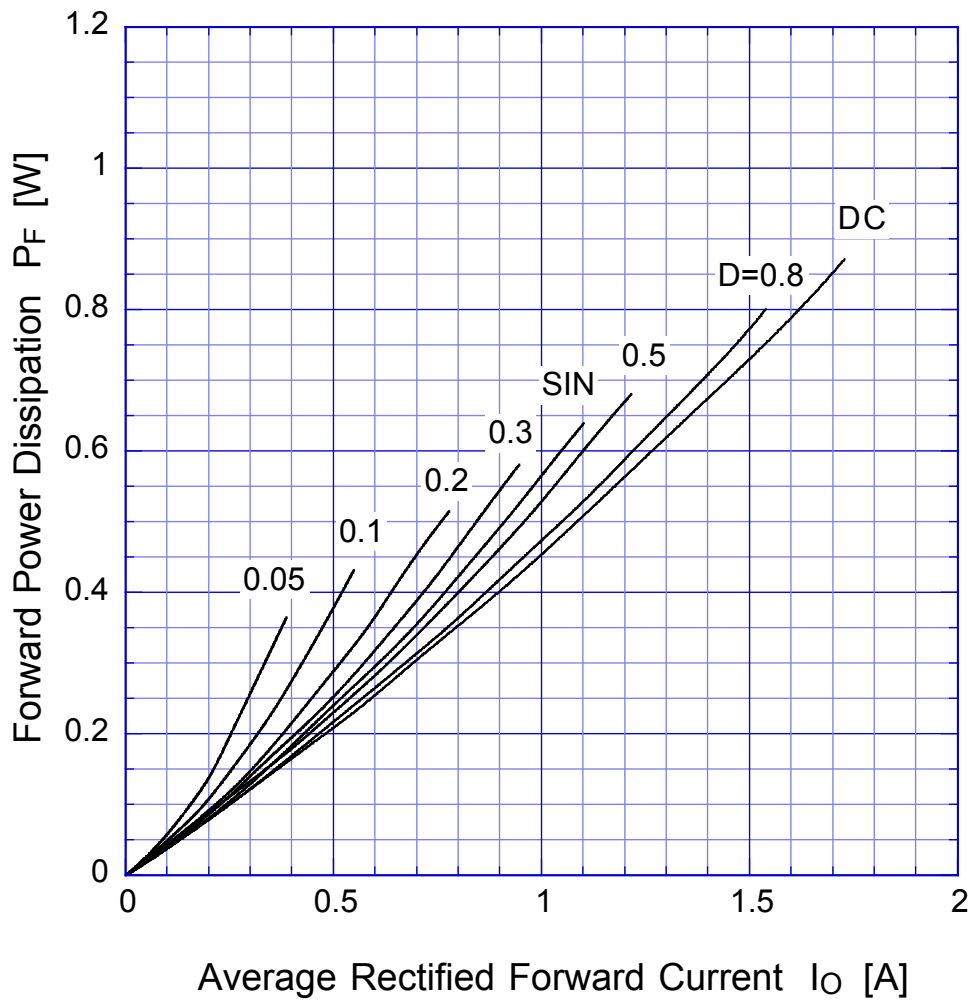

$T_j = 150^\circ\text{C}$

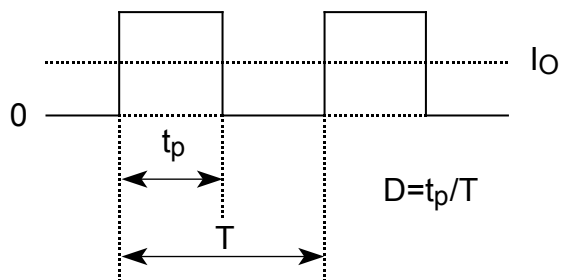

D2FS6

Derating Curve

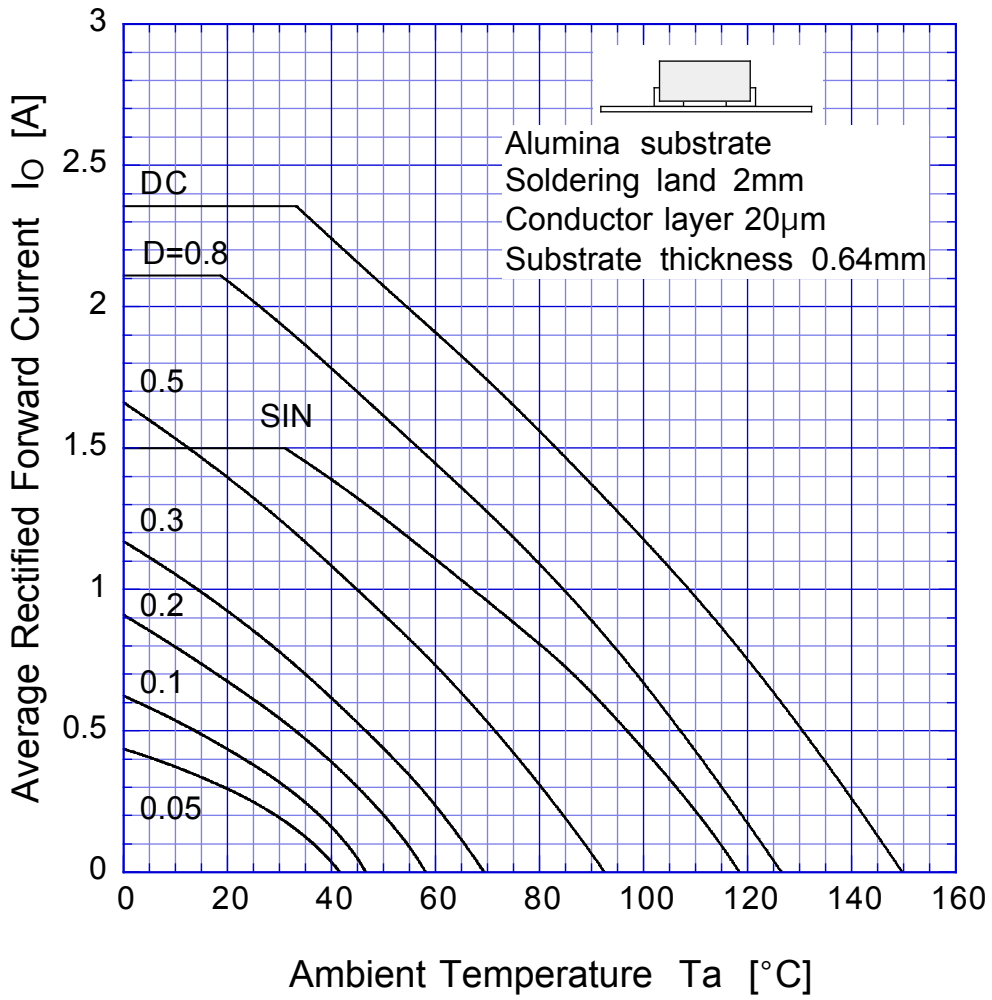

$V_R = 30V$

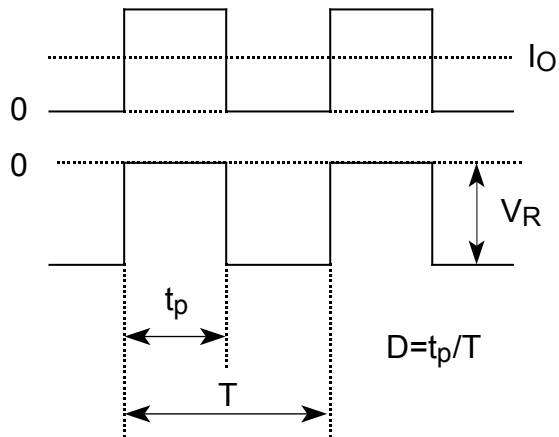

D2FS6

Derating Curve

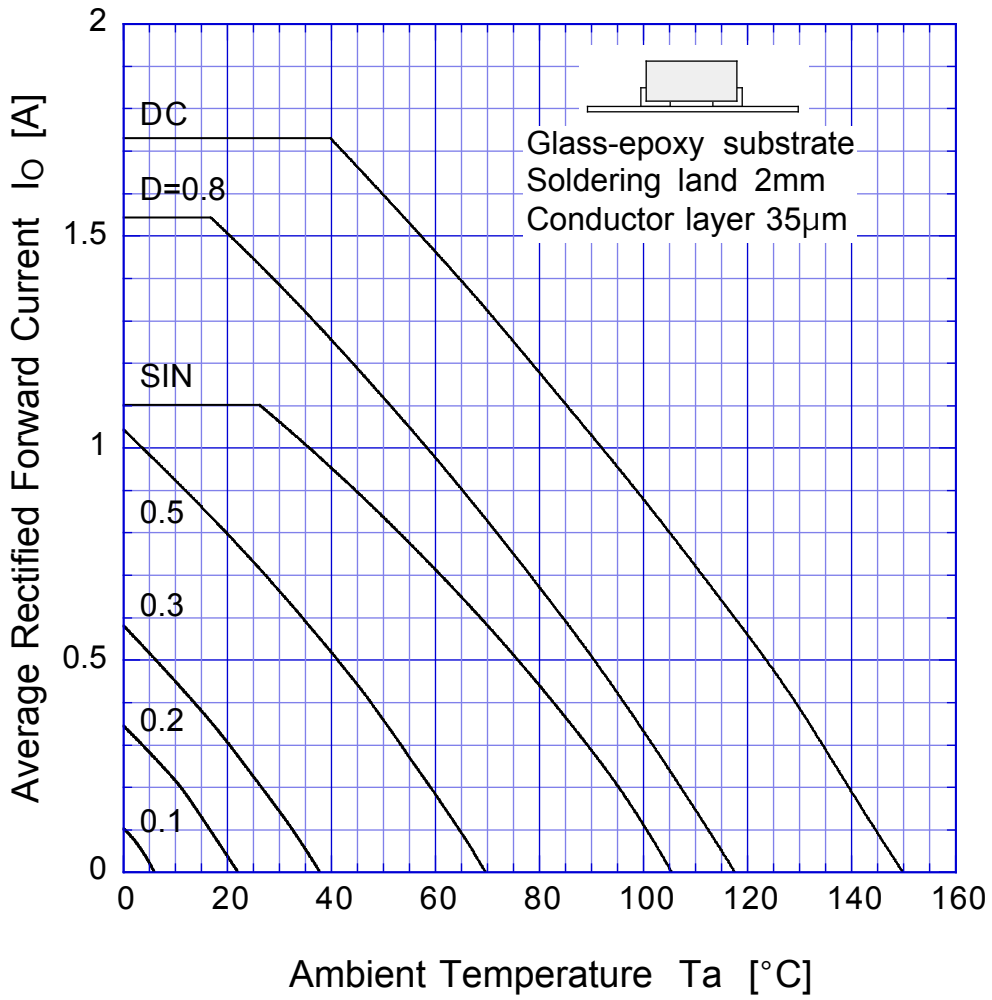

$V_R = 30V$



D2FS6

Peak Surge Forward Capability

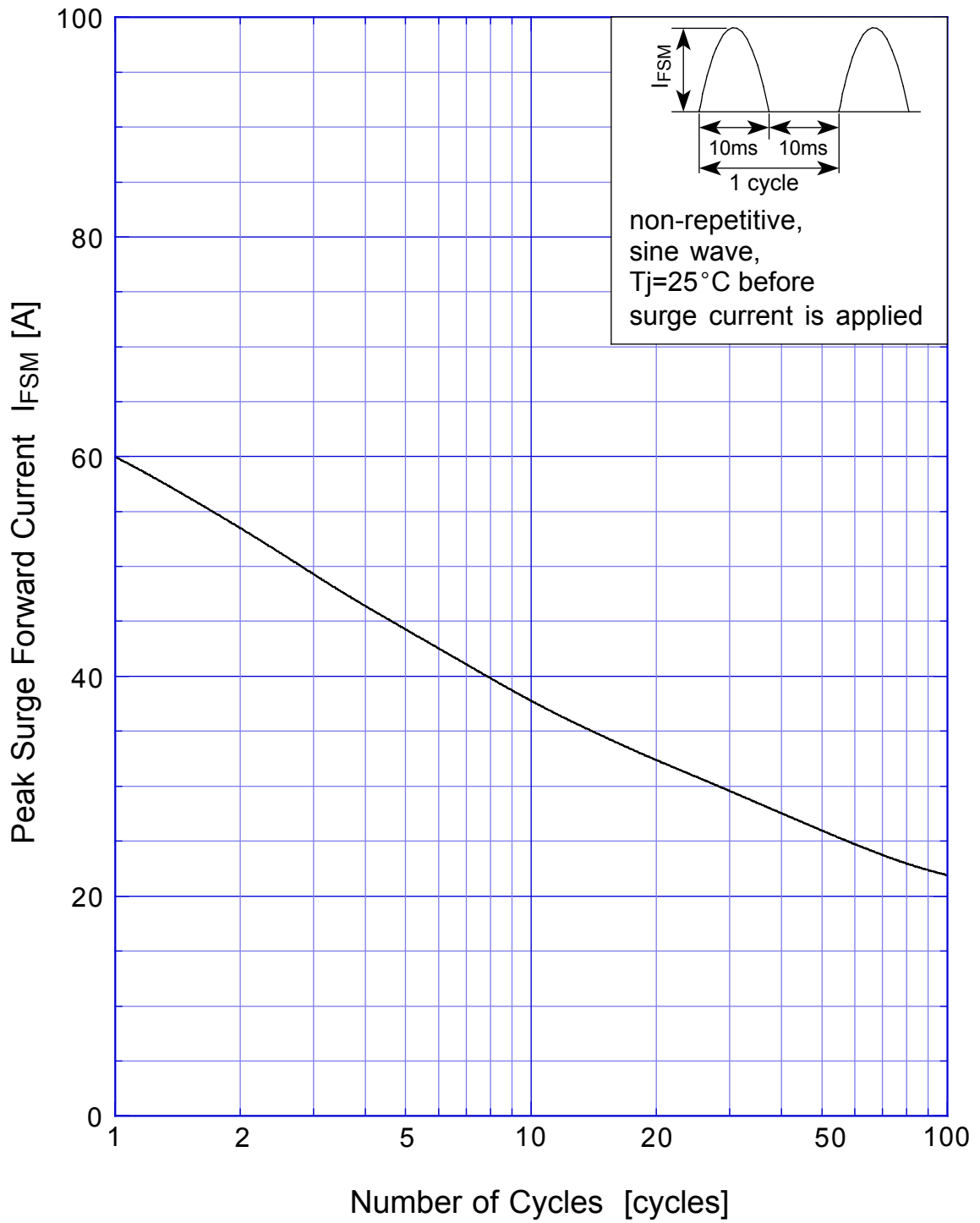

SBD Repetitive Surge Reverse Power Derating Curve

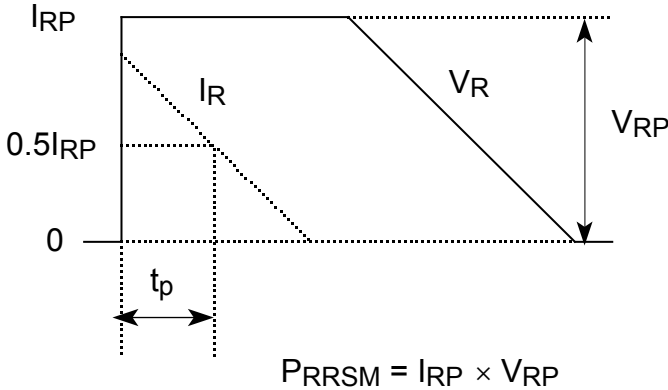
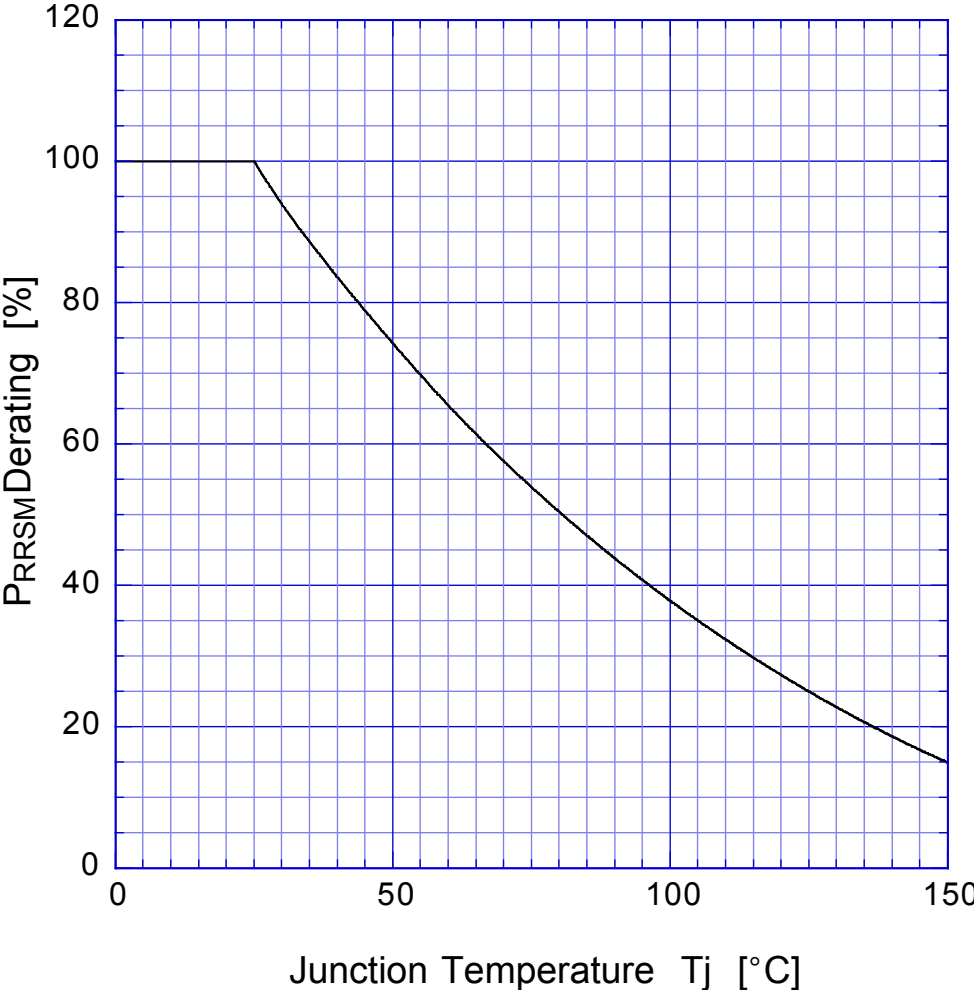

SBD

Repetitive Surge Reverse Power Capability

