

SHINDENGEN

Schottky Rectifiers (SBD)

Single

D3FS6

60V 3A

OUTLINE DIMENSIONS

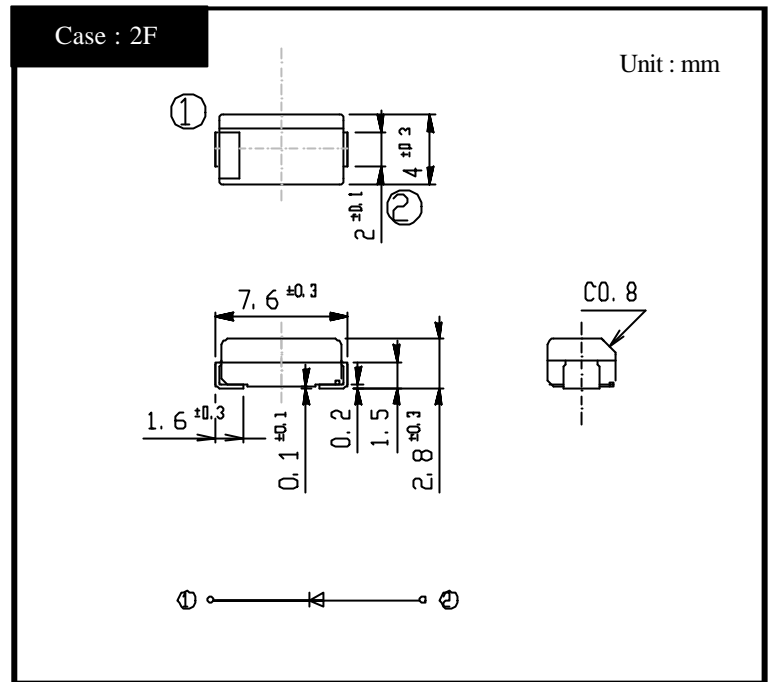

RATINGS

Absolute Maximum Ratings (If not specified $T_I=25$)

Item	Symbol	Conditions	Ratings	Unit
Storage Temperature	T_{stg}		-55 ~ 150	
Operating Junction Temperature	T_j		150	
Peake Reverse Voltage	V_{RM}		60	V
Repetitive Peak Surge Reverse Voltage	V_{RRSM}	Pulse width 0.5ms, duty 1/40	65	V
Average Rectified Forward Current	I_O	50Hz sine wave, R-load $T_a=25$ On alumina substrate	1.65	A
		50Hz sine wave, R-load $T_I=87$	3.0	
Peak Surge Forward Current	I_{FSM}	50Hz sine wave, Non-repetitive 1 cycle peak value, $T_j=25$	80	A
Repetitive Peak Surge Reverse Power	P_{RRSM}	Pulse width 10 μ s, $T_j=25$	330	W

Electrical Characteristics (If not specified $T_I=25$)

Item	Symbol	Conditions	Ratings	Unit
Forward Voltage	V_F	$I_F=3A$, Pulse measurement	Max.0.58	V
Reverse Current	I_R	$V_R=V_{RM}$, Pulse measurement	Max.2.5	mA
Junction Capacitance	C_j	$f=1MHz$, $V_R=10V$	Typ.130	pF
Thermal Resistance	θ	j-l junction to lead	Max.24	/W
		ja junction to ambient On alumina substrate	Max.90	
		ja junction to ambient On glass-epoxy substrate	Max.124	

D3FS6

Forward Voltage

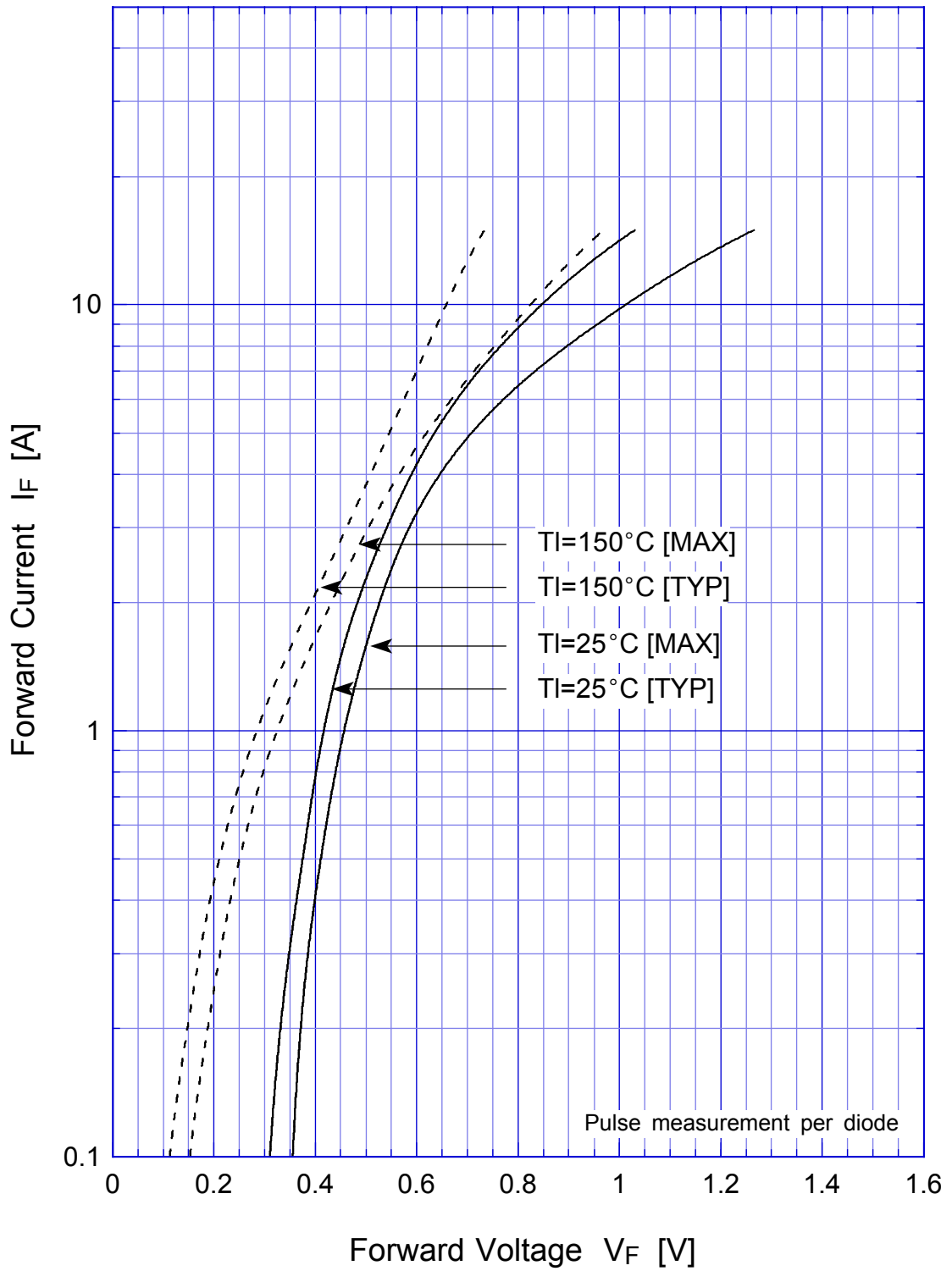

D3FS6

Junction Capacitance

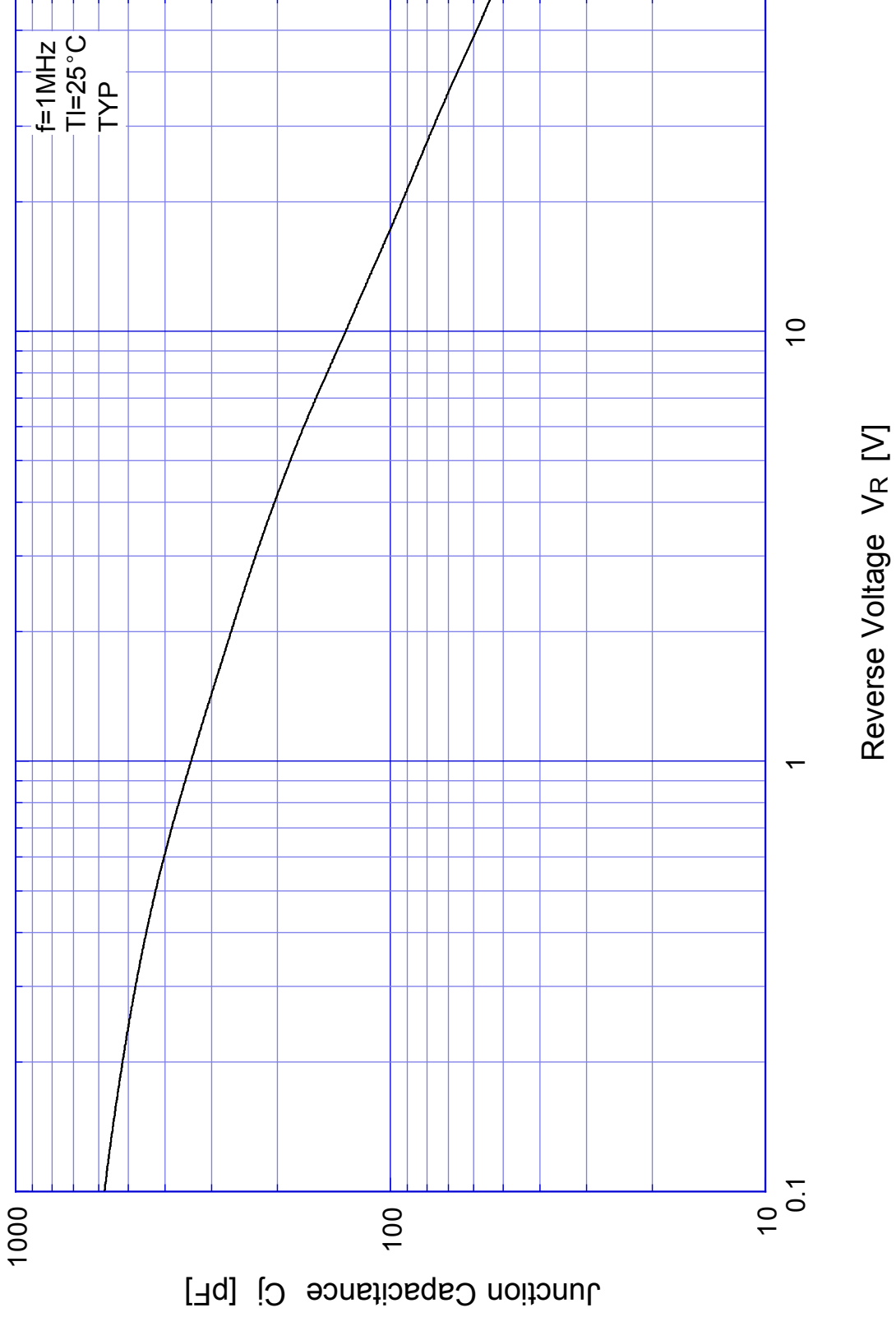

D3FS6

Reverse Current

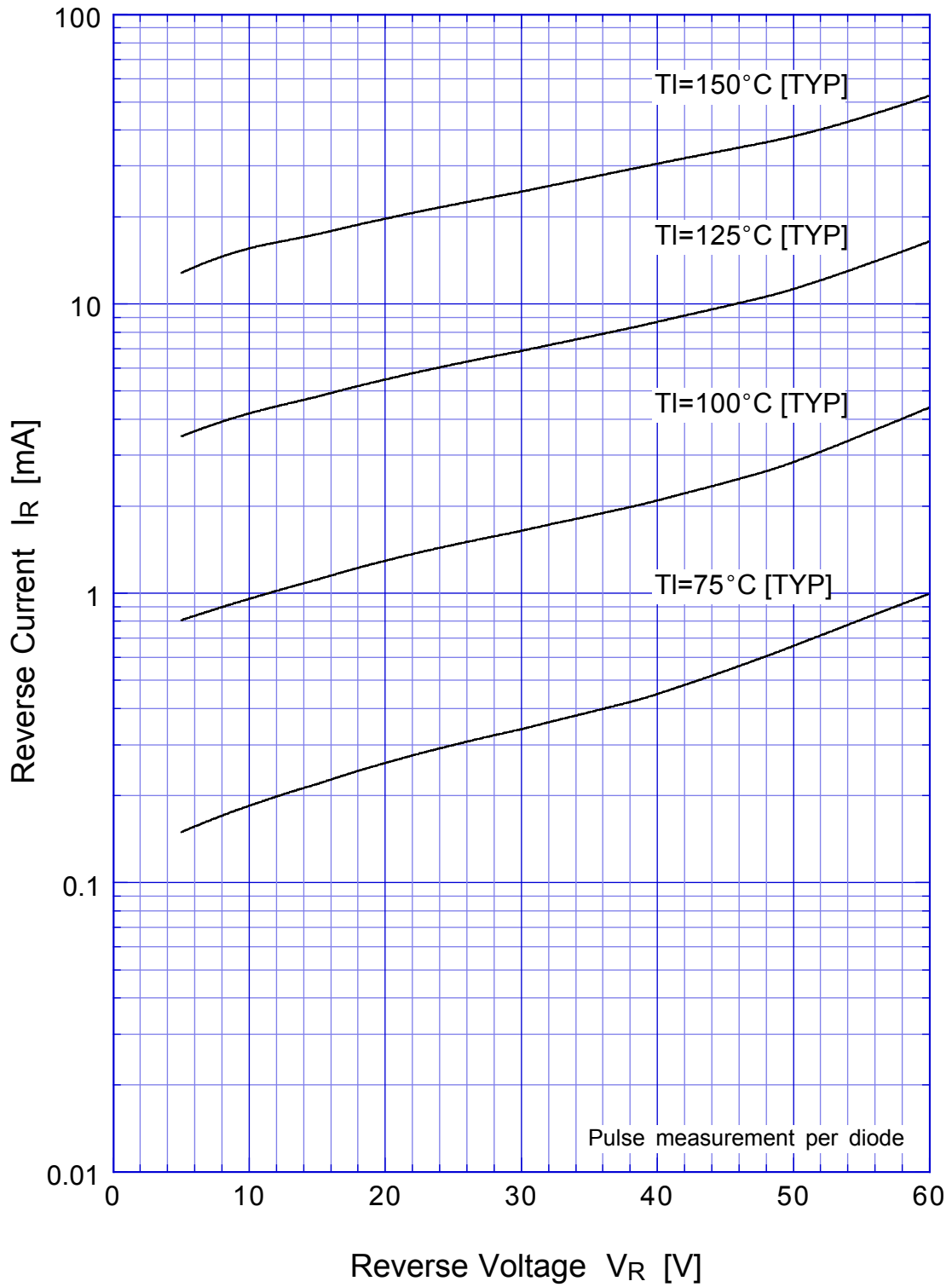

D3FS6

Reverse Power Dissipation

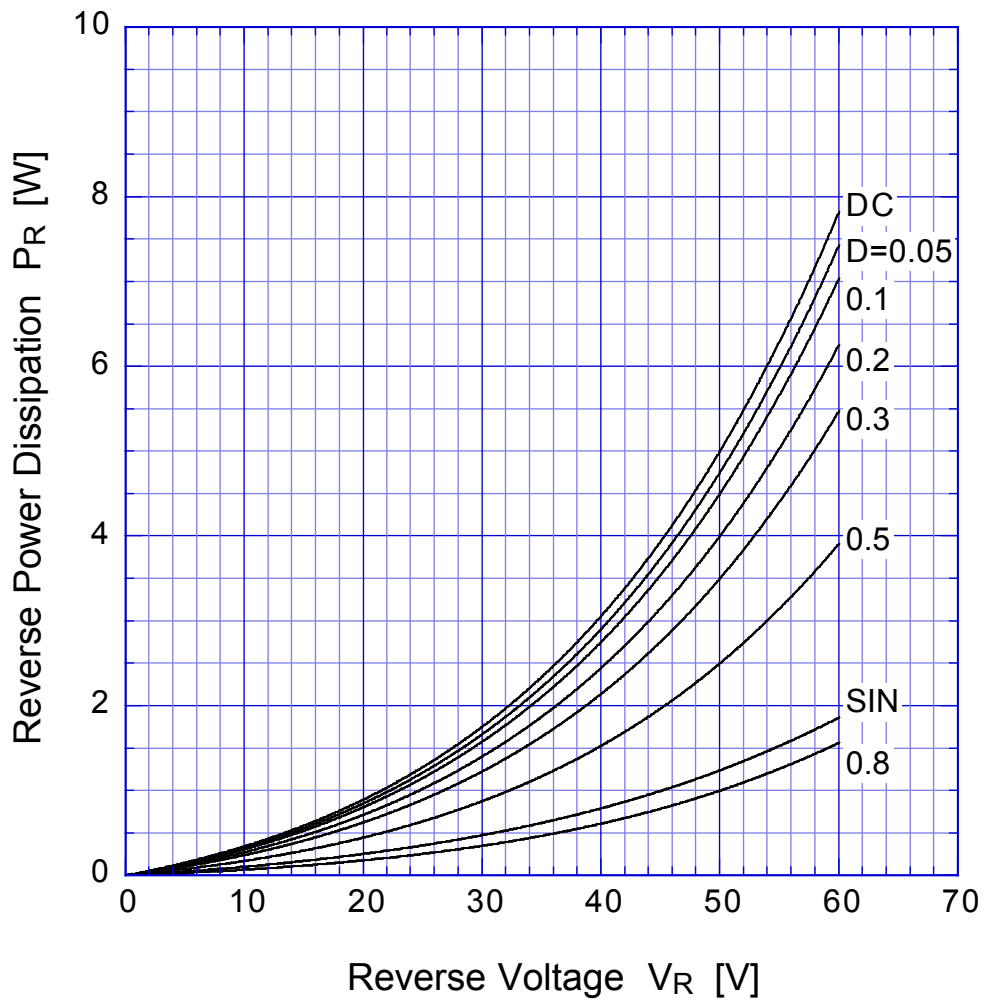

$T_j = 150^\circ\text{C}$

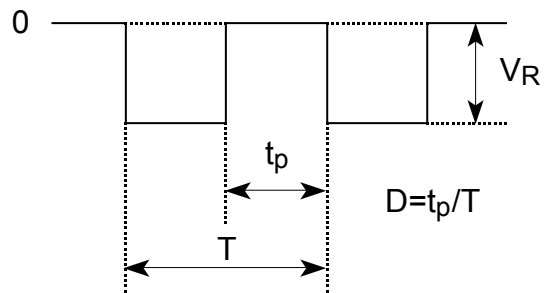

D3FS6

Forward Power Dissipation

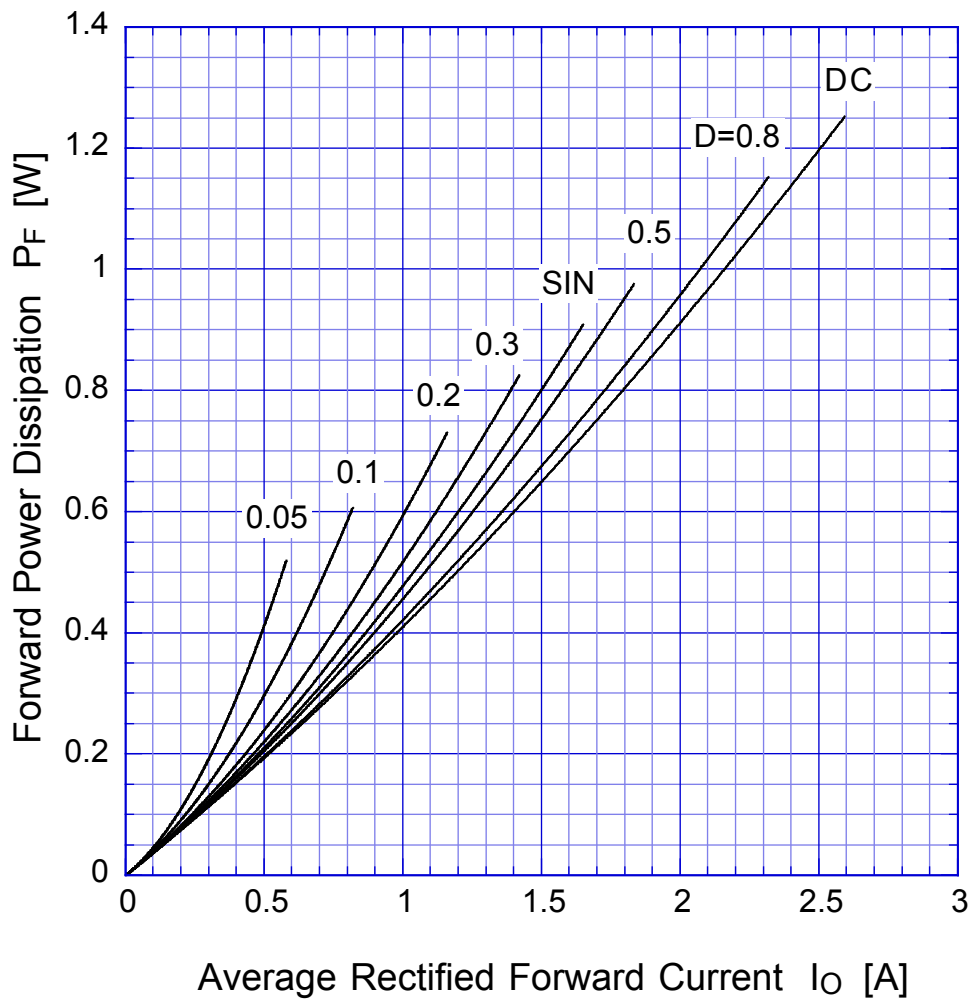

$T_j = 150^\circ\text{C}$

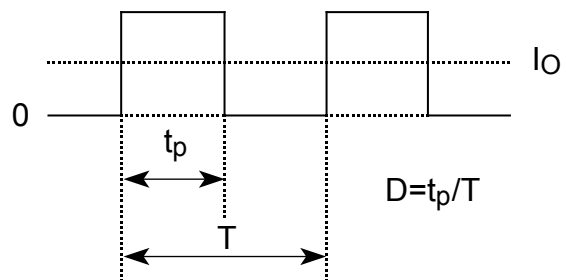

D3FS6

Derating Curve

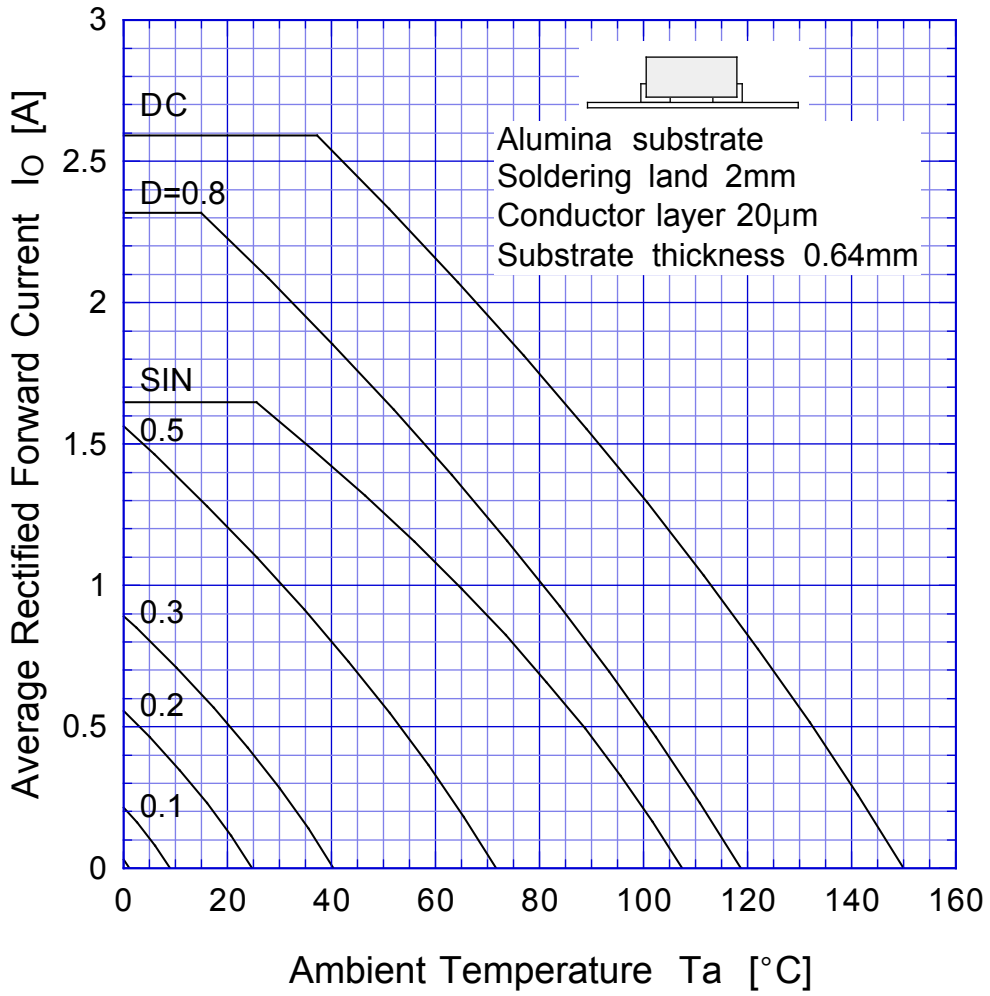

$V_R = 30V$

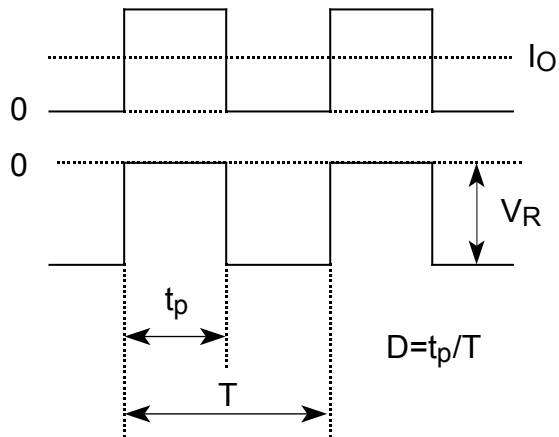

D3FS6

Derating Curve

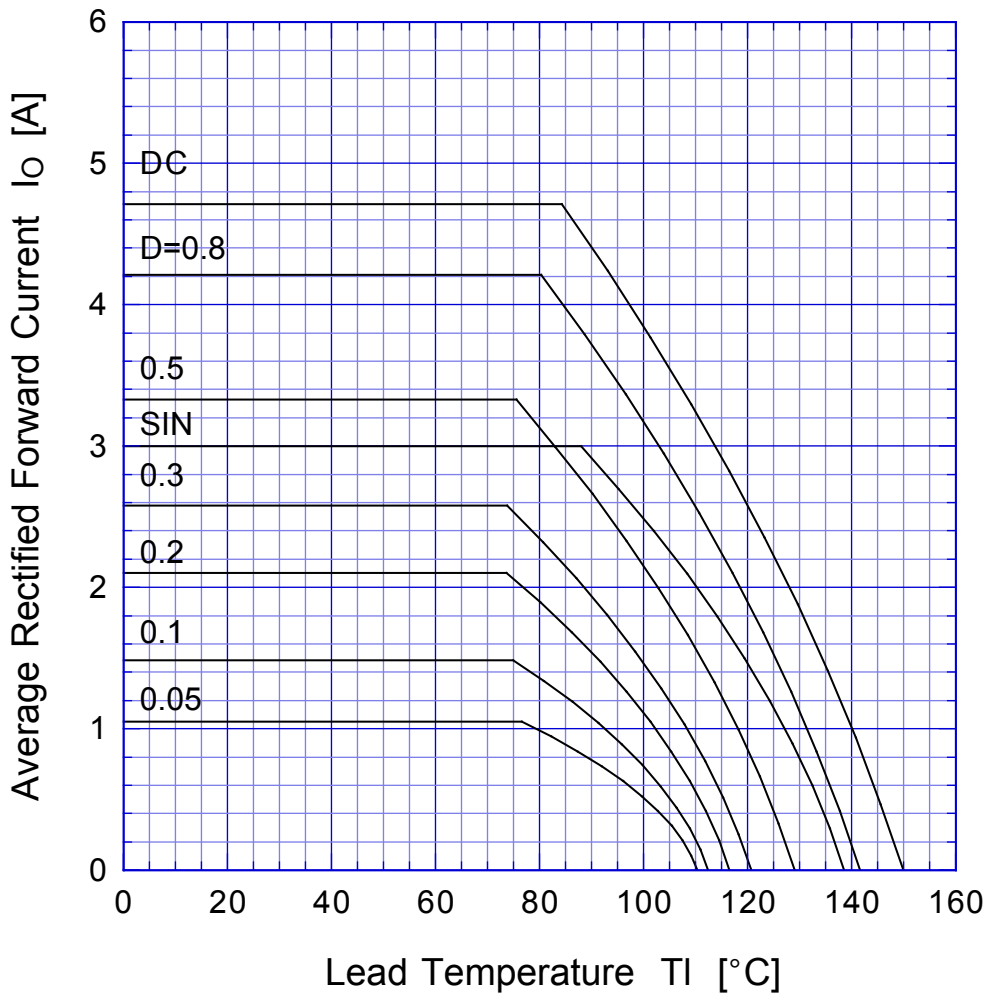

$V_R = 30V$

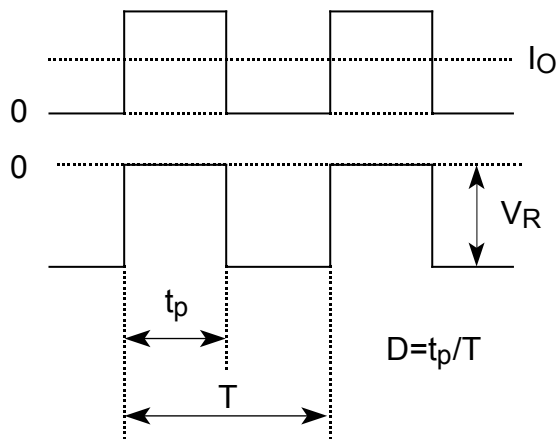

D3FS6

Peak Surge Forward Capability

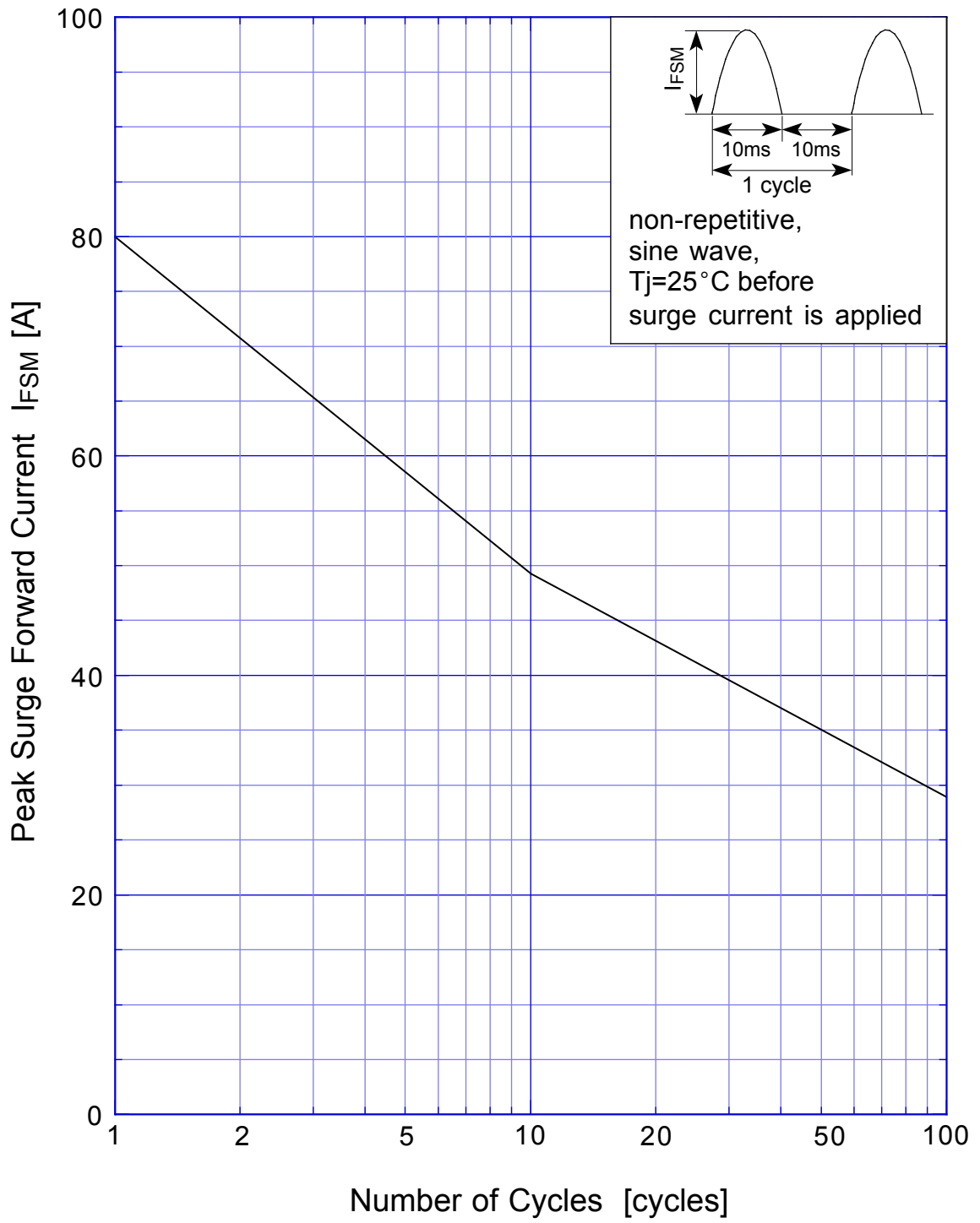

SBD Repetitive Surge Reverse Power Derating Curve

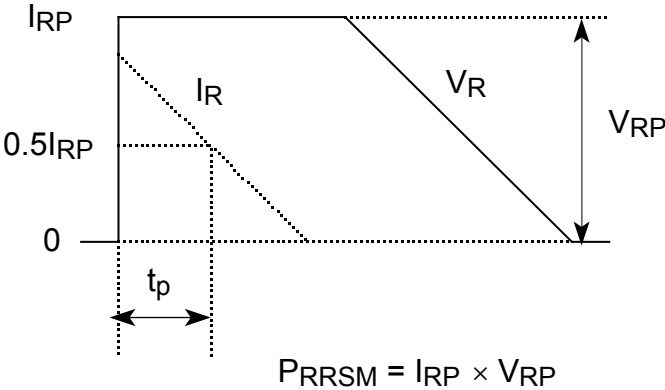
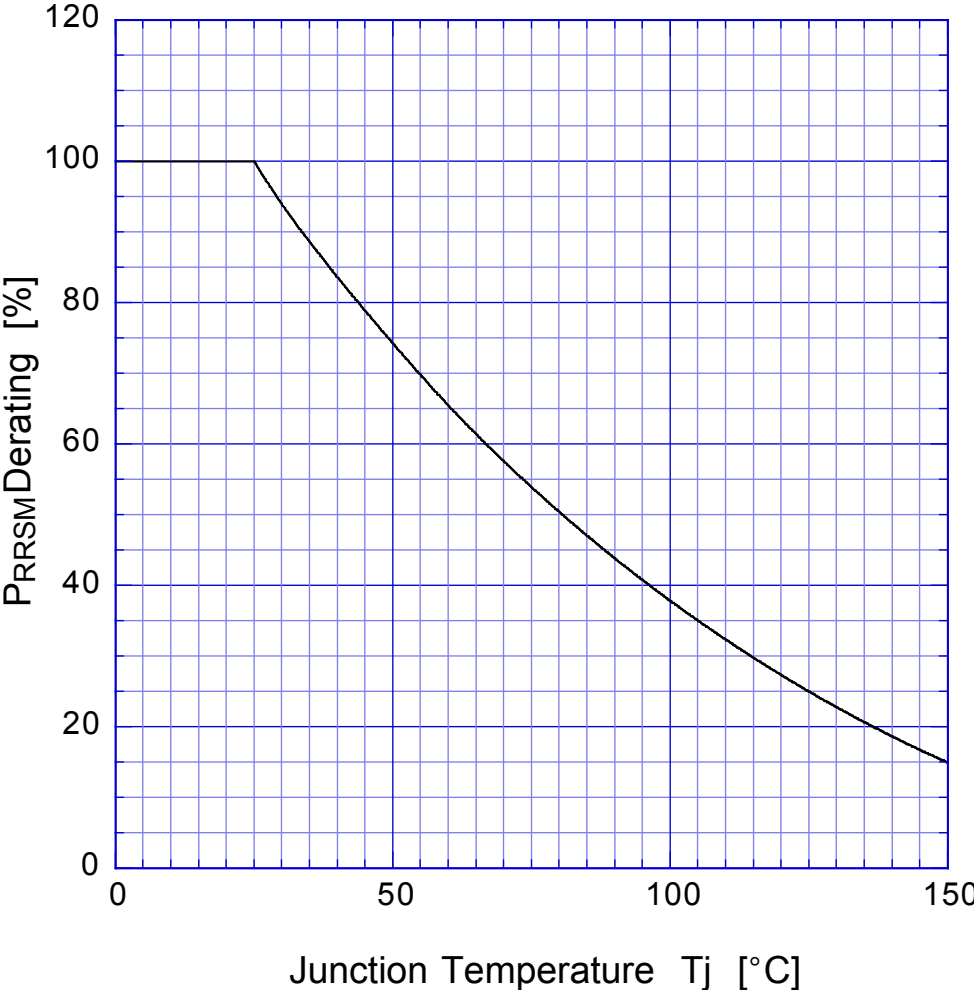

SBD

Repetitive Surge Reverse Power Capability

