

SHINDENGEN

Schottky Rectifiers (SBD)

Single

SF5S6

60V 5A

FEATURES

- Tj150
- P_{RRSM} avalanche guaranteed
- Fully Isolated Molding
- Dielectric strength 1.5KV guaranteed

APPLICATION

- Switching power supply
- DC/DC converter
- Home Appliances, Office Equipment
- Telecommunication

OUTLINE DIMENSIONS

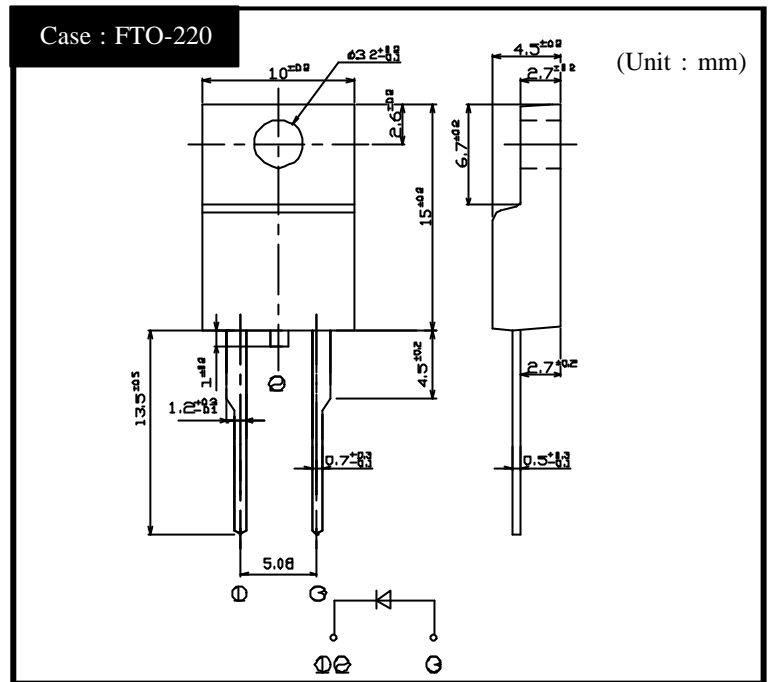

RATINGS

Absolute Maximum Ratings (If not specified $T_c=25$)

Item	Symbol	Conditions	Ratings	Unit
Storage Temperature	T_{stg}		-55 ~ 150	
Operating Junction Temperature	T_j		150	
Maximum Reverse Voltage	V_{RM}		60	V
Repetitive Peak Surge Reverse Voltage	V_{RRSM}	Pulse width 0.5ms, duty 1/40	65	V
Average Rectified Forward Current	I_O	50Hz sine wave, R-load, $T_c=134$	5	A
Peak Surge Forward Current	I_{FSM}	50Hz sine wave, Non-repetitive 1 cycle peak value, $T_j=25$	150	A
Repetitive Peak Surge Reverse Power	P_{RRSM}	Pulse width 10 μ s, $T_j=25$	330	W
Dielectric Strength	V_{dis}	Terminals to case, AC 1 minute	1.5	kV
Mounting Torque	TOR	(Recommended torque 0.3N·m)	0.5	N·m

Electrical Characteristics (If not specified $T_c=25$)

Item	Symbol	Conditions	Ratings	Unit
Forward Voltage	V_F	$I_F=5A$ Pulse measurement	Max.0.58	V
Reverse Current	I_R	$V_R=V_{RM}$ Pulse measurement	Max. 4.5	mA
Junction Capacitance	C_j	$f=1MHz, V_R=10V$	Typ.260	pF
Thermal Resistance	θ_{jc}	junction to case	Max.3.5	/W

SF5S6

Forward Voltage

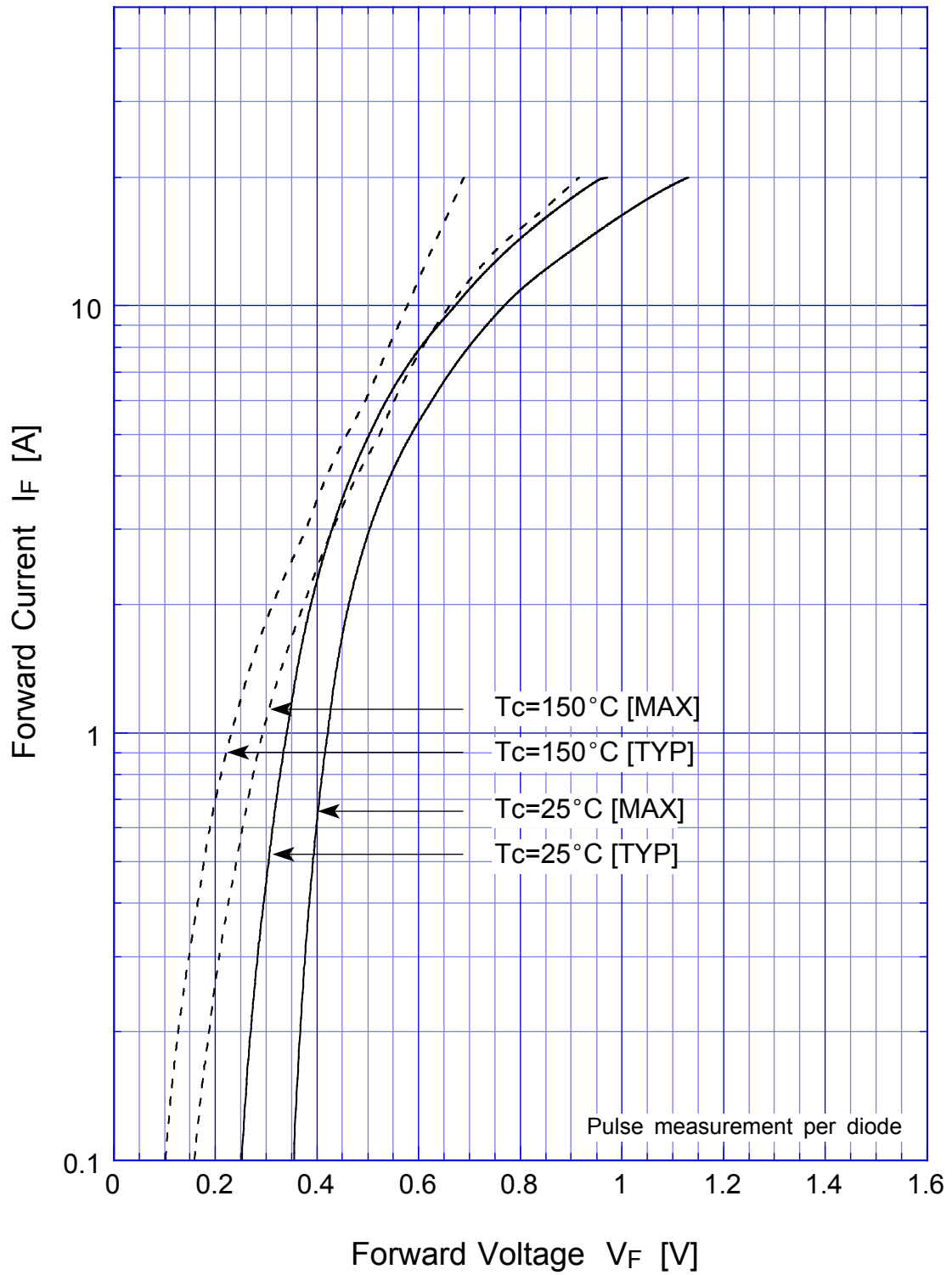

SF5S6

Junction Capacitance

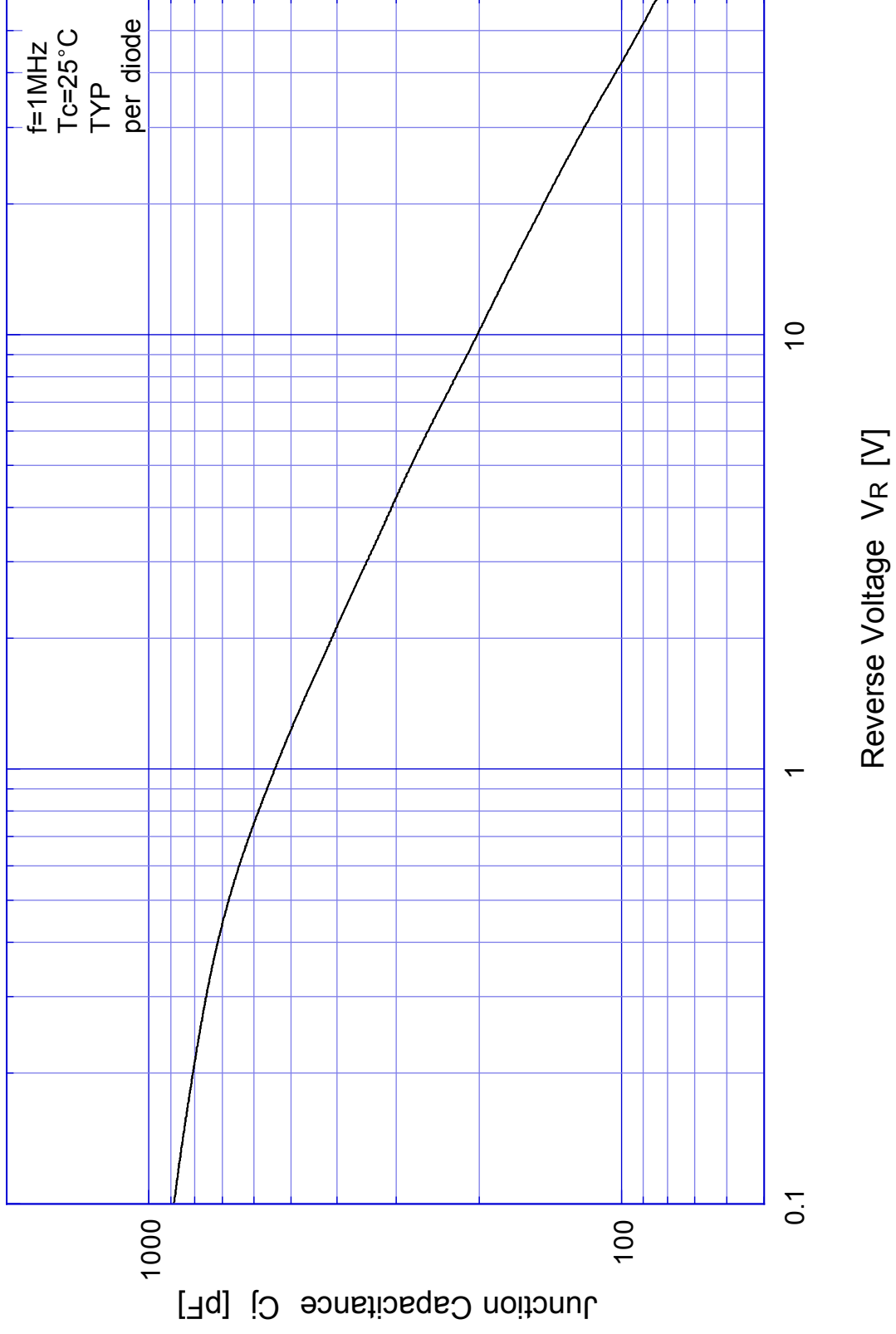

SF5S6

Reverse Current

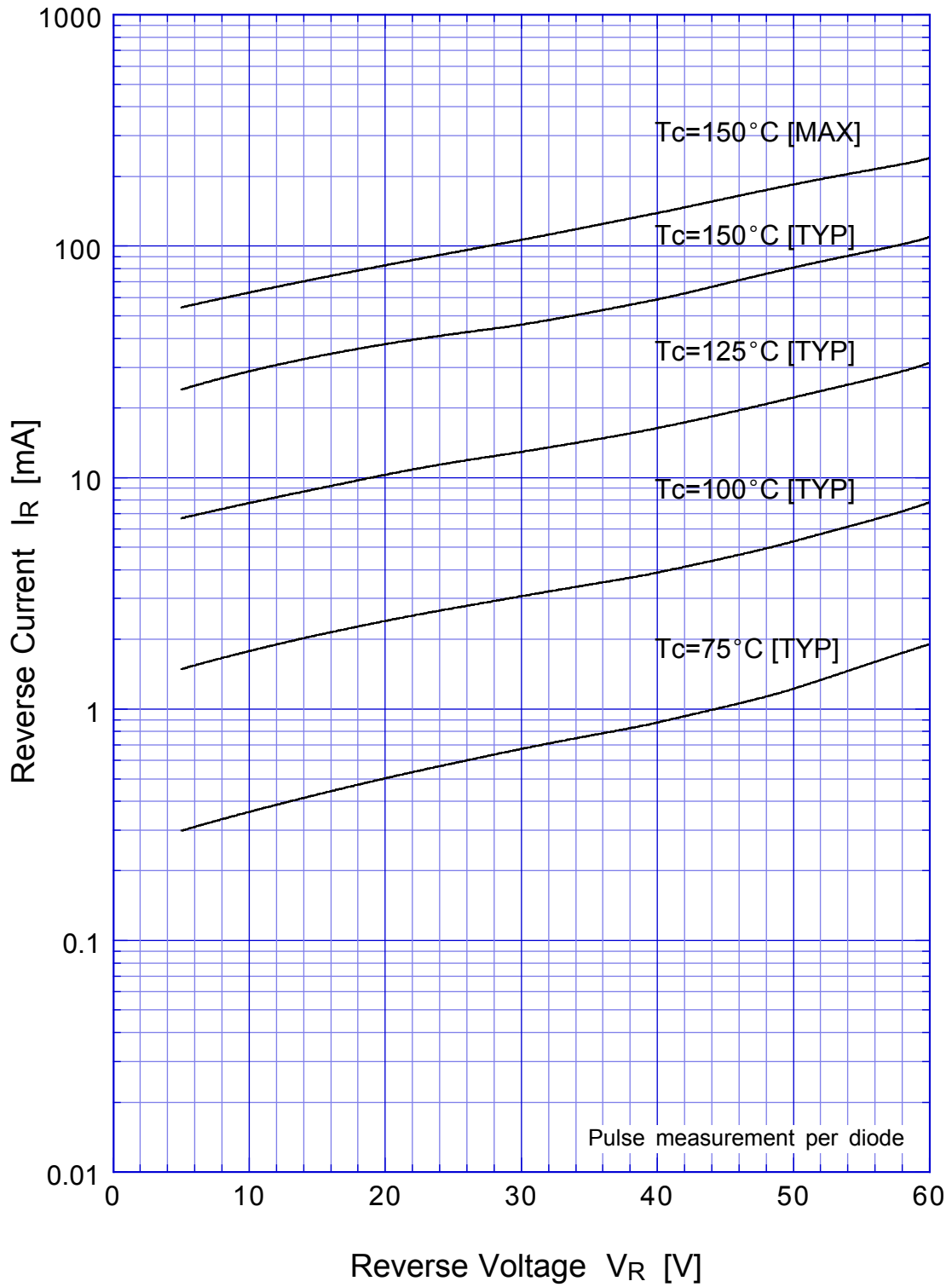

SF5S6

Reverse Power Dissipation

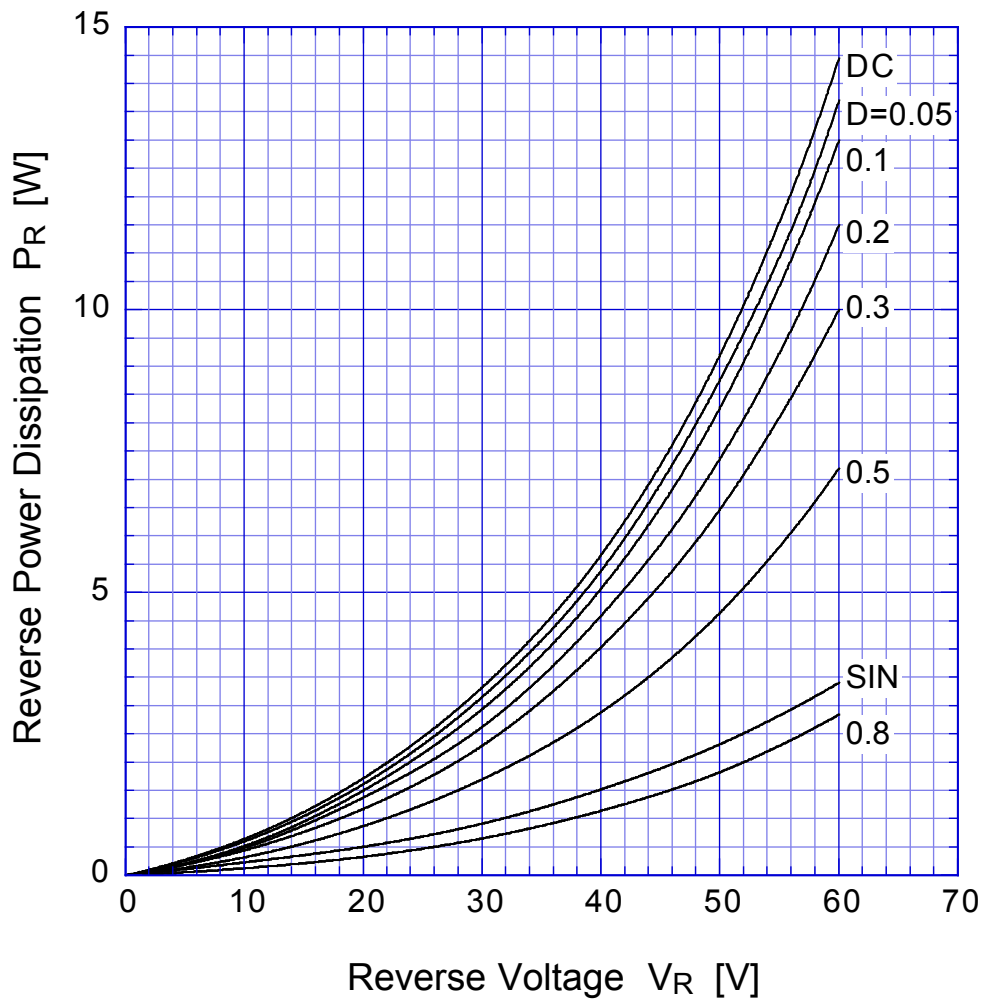

$T_j = 150^\circ\text{C}$

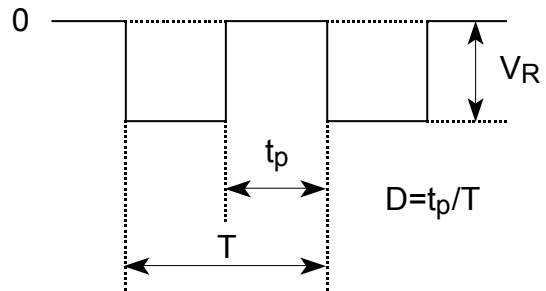

SF5S6

Forward Power Dissipation

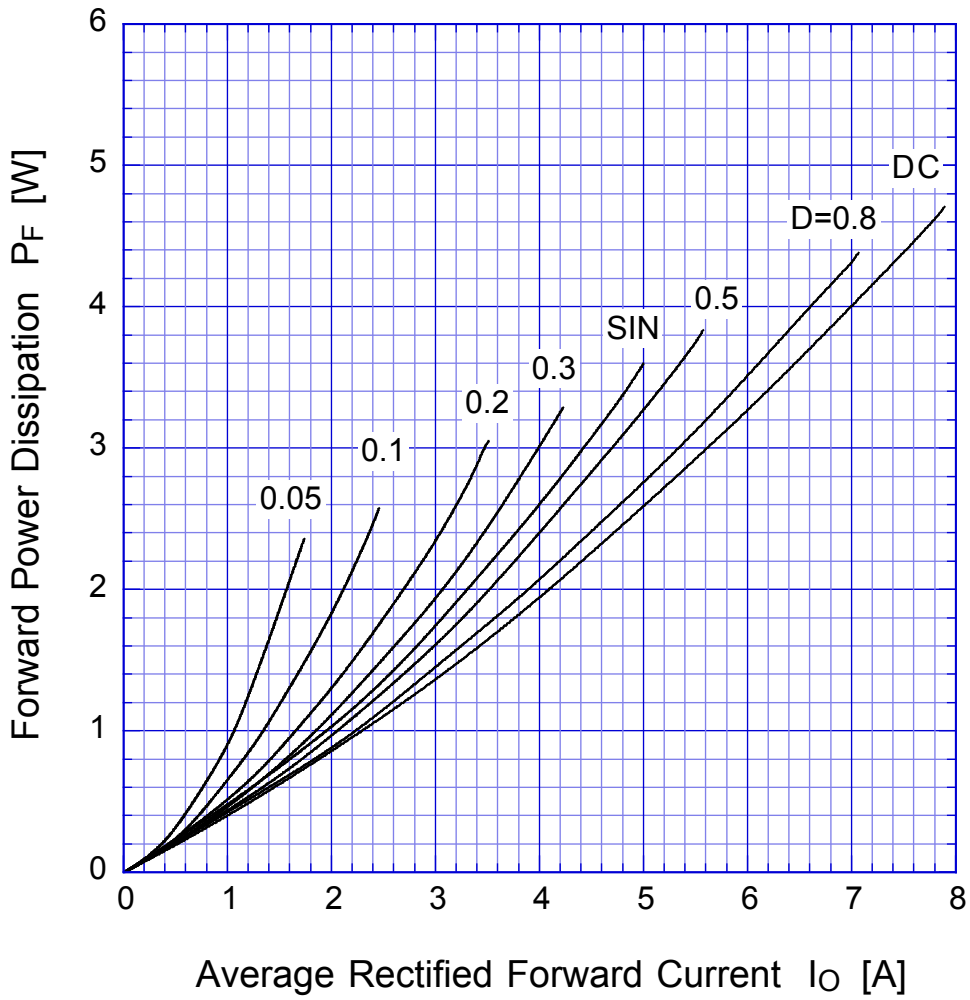

$T_j = 150^\circ\text{C}$

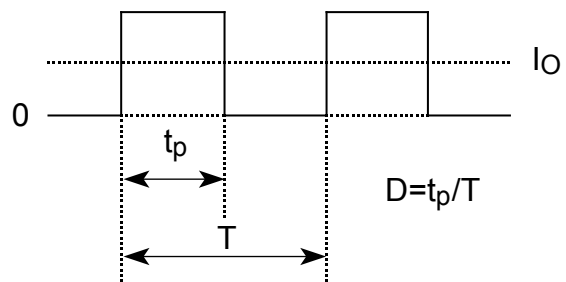

SF5S6

Derating Curve

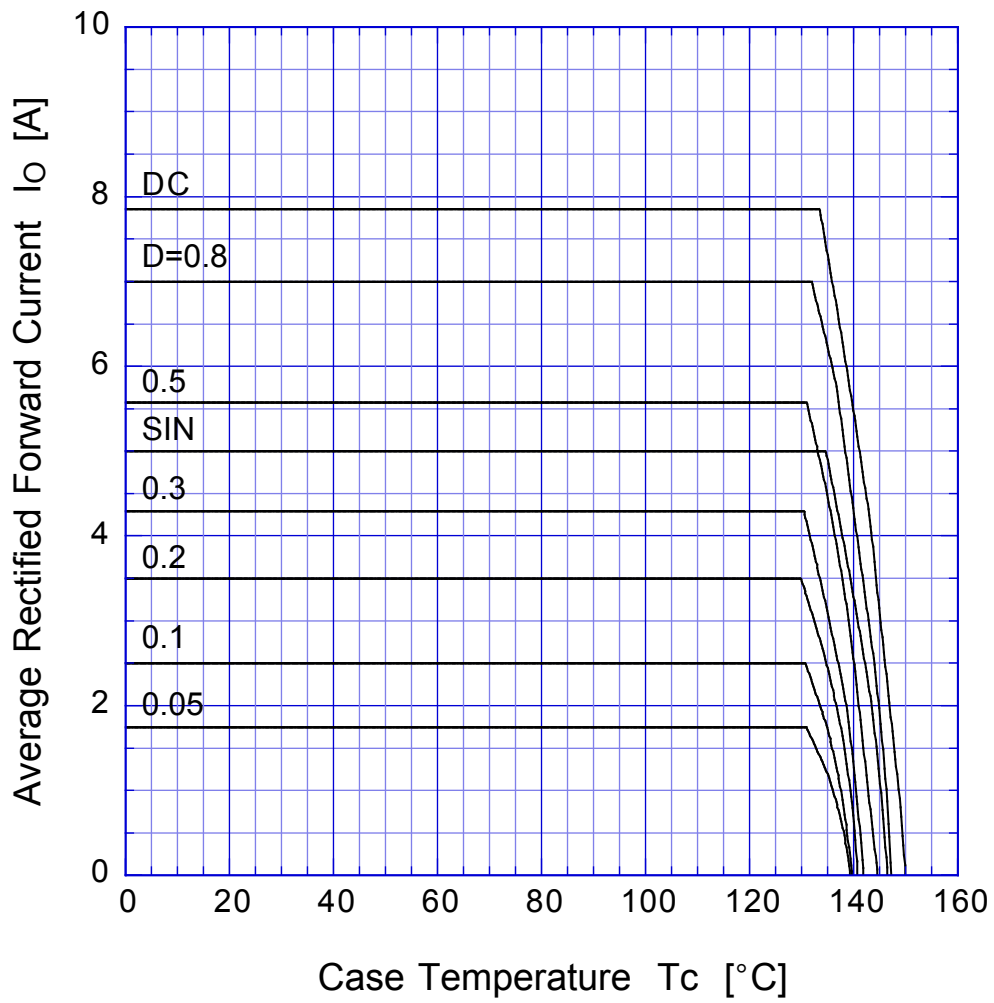

$V_R = 30V$

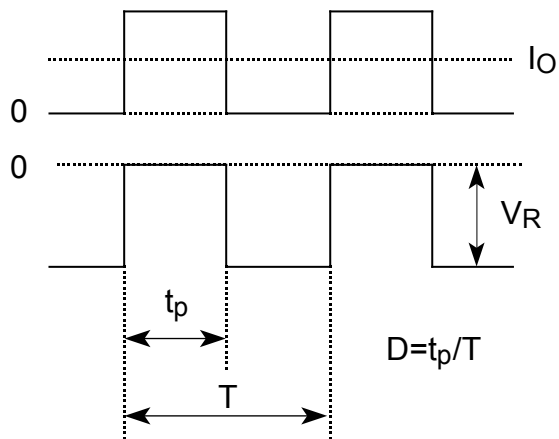

SF5S6

Peak Surge Forward Capability

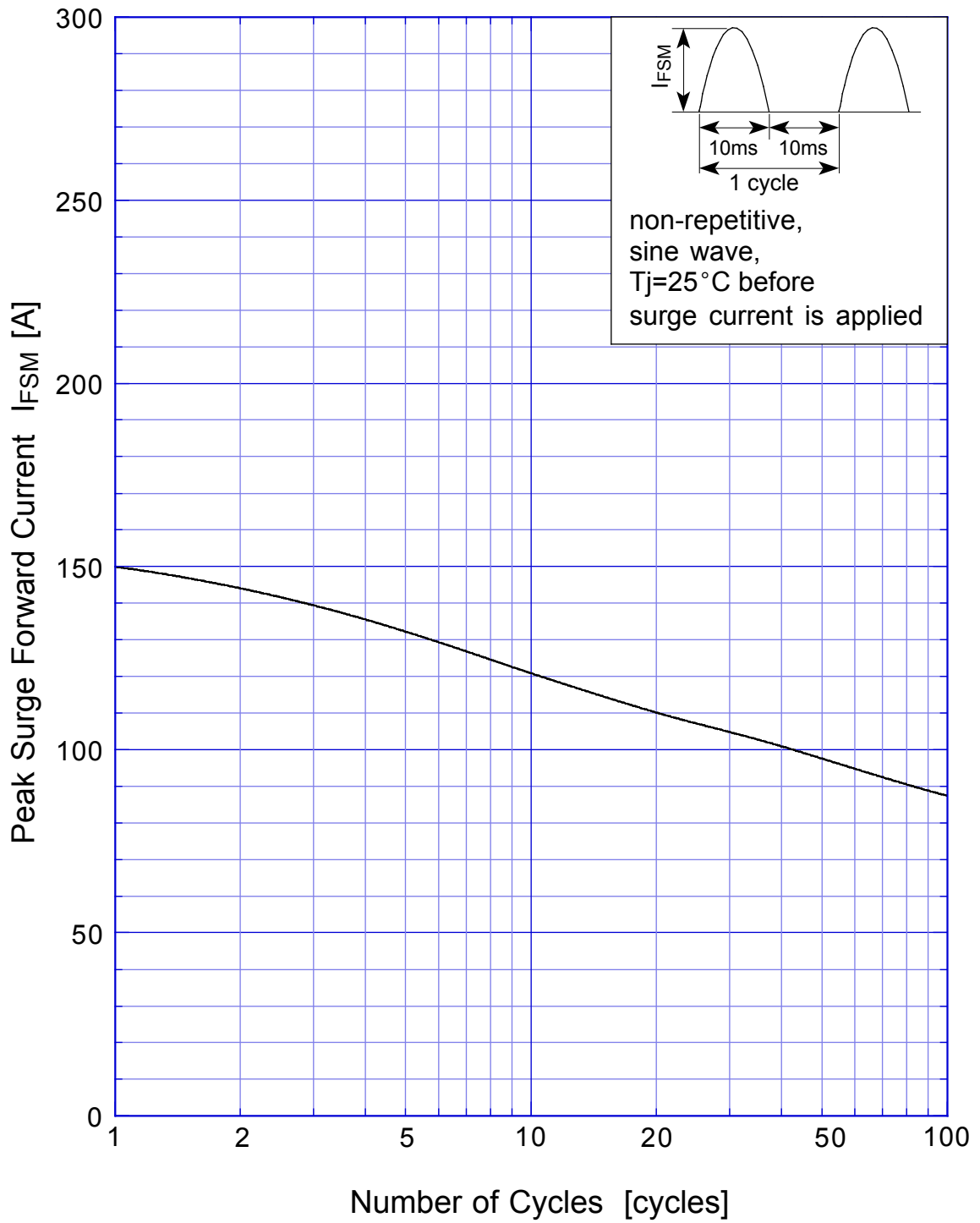

SBD Repetitive Surge Reverse Power Derating Curve



SBD

Repetitive Surge Reverse Power Capability

