

# SHINDENGEN

## Sidac

# K1V33(W)

### OUTLINE DIMENSIONS

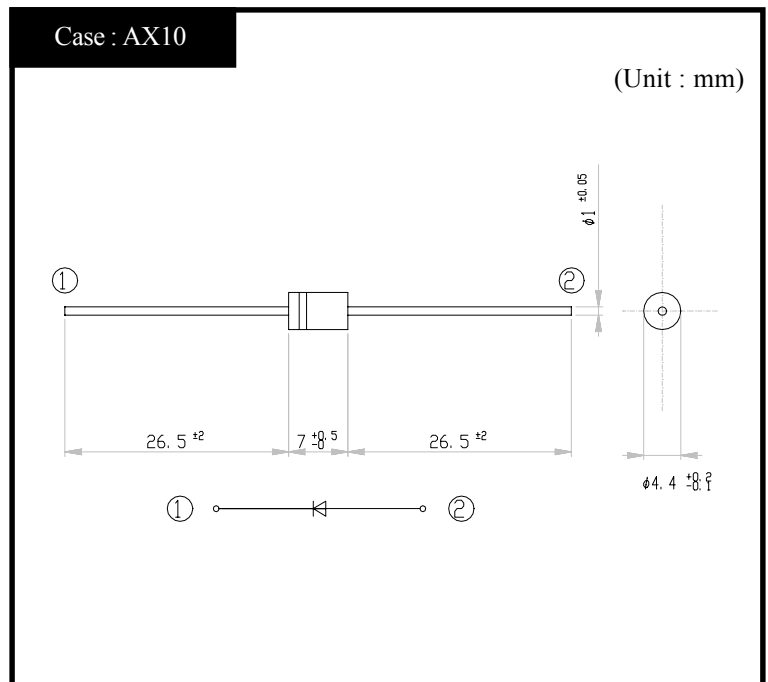

### RATINGS

#### ● Absolute Maximum Ratings

Item	Symbol	Conditions	Ratings	Unit
Storage Temperature	$T_{stg}$		-40~125	°C
Operating Junction Temperature	$T_j$		125	°C
Maximum Off-state Voltage	$V_{DRM}$		270	V
RMS On-state Current	$I_T$	$T_l = 92^\circ\text{C}$ , 50Hz sine wave ( $\theta = 180^\circ$ )	1	A
Surge On-state Current	$I_{TSM}$	$T_j = 25^\circ\text{C}$ , 50Hz sine wave ( $\theta = 180^\circ$ ), non-repetitive 1-cycle peak value	13	A
Pulse On-state Current	$I_{TRM}$	$T_a = 25^\circ\text{C}$ , pulse width $t_o = 10 \mu\text{s}$ , sine wave, repetitive peak value $f = 1 \text{ kHz}$	15	A
		$T_a = 25^\circ\text{C}$ , pulse width $t_o = 10 \mu\text{s}$ , sine wave, repetitive peak value $f = 60 \text{ Hz}$	40	
Critical Rate of Rise of On-state Current	$di_T/dt$		50	A/ $\mu\text{s}$

#### ● Electrical Characteristics ( $T_l=25^\circ\text{C}$ )

Item	Symbol	Conditions	Ratings	Unit
Breakover Voltage	$V_{BO}$	$I_B = 0$ , 50Hz sine wave	309~355	V
Off-state Current	$I_{DRM}$	$V_D = V_{DRM}$	Max 10	$\mu\text{A}$
Breakover Current	$I_{BO}$		Max 0.5	mA
Holding Current	$I_H$		TYP 50	mA
On-state Voltage	$V_T$	$I_T = 1\text{A}$	Max 3.0	V
Switching Resistance	$R_S$		Min 0.1	k $\Omega$
Thermal Resistance	$\theta_{jl}$	Junction to lead	Max 15	°C/W

#### ● Standard Design with P.C.B.

Item	Symbol	Conditions	Standard	Unit
RMS On-state Current	$I_T$	Assembled in P.C.B., $T_a = 25^\circ\text{C}$ , soldering land 3mm $\phi$	0.55	A

K1V33(W)  
K1V34(W)  
K1V36(W)  
K1V38(W) Typical On-State Voltage

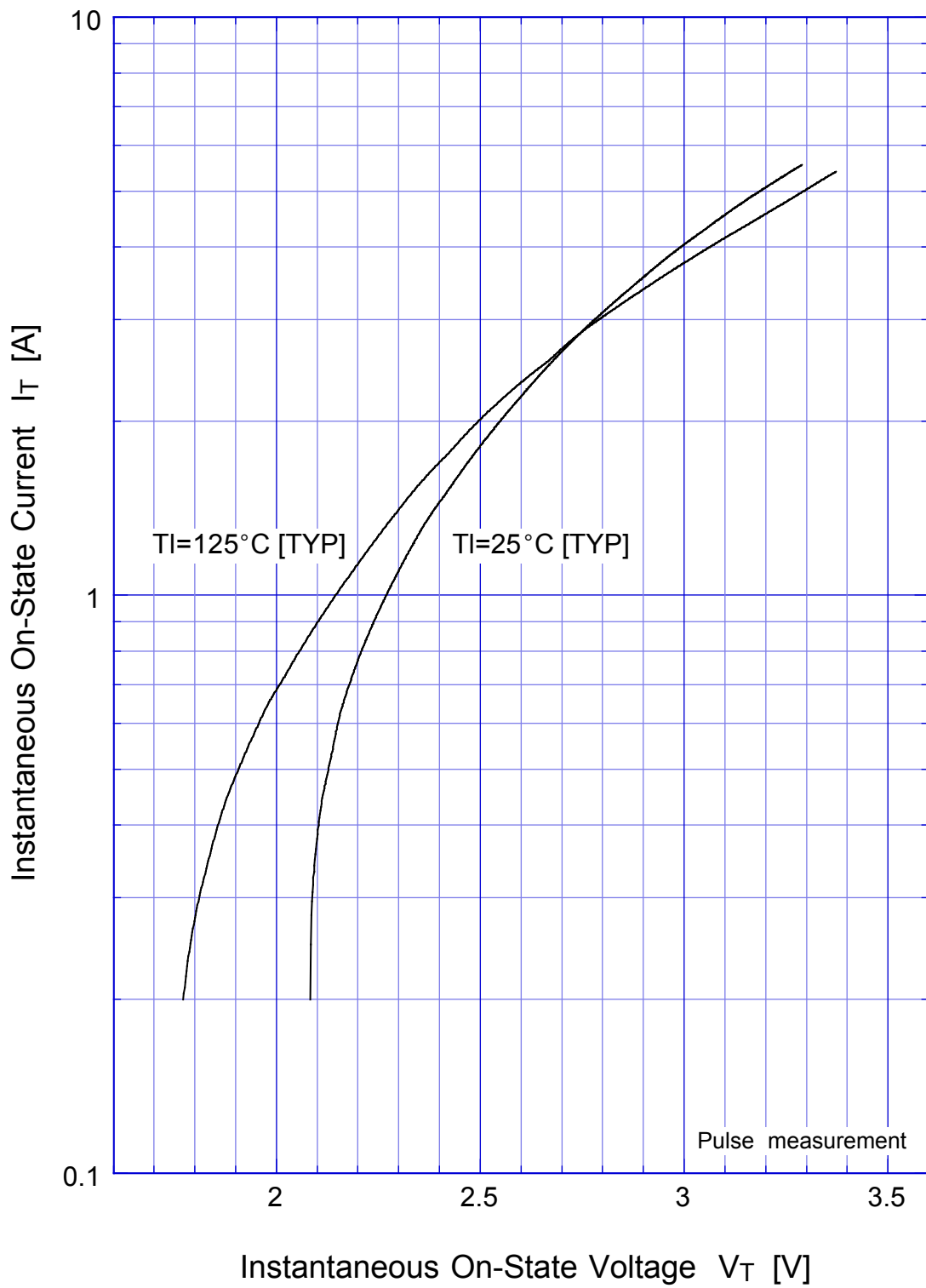

K1V33(W)

K1V34(W)

K1V36(W)

K1V38(W)

Power Dissipation

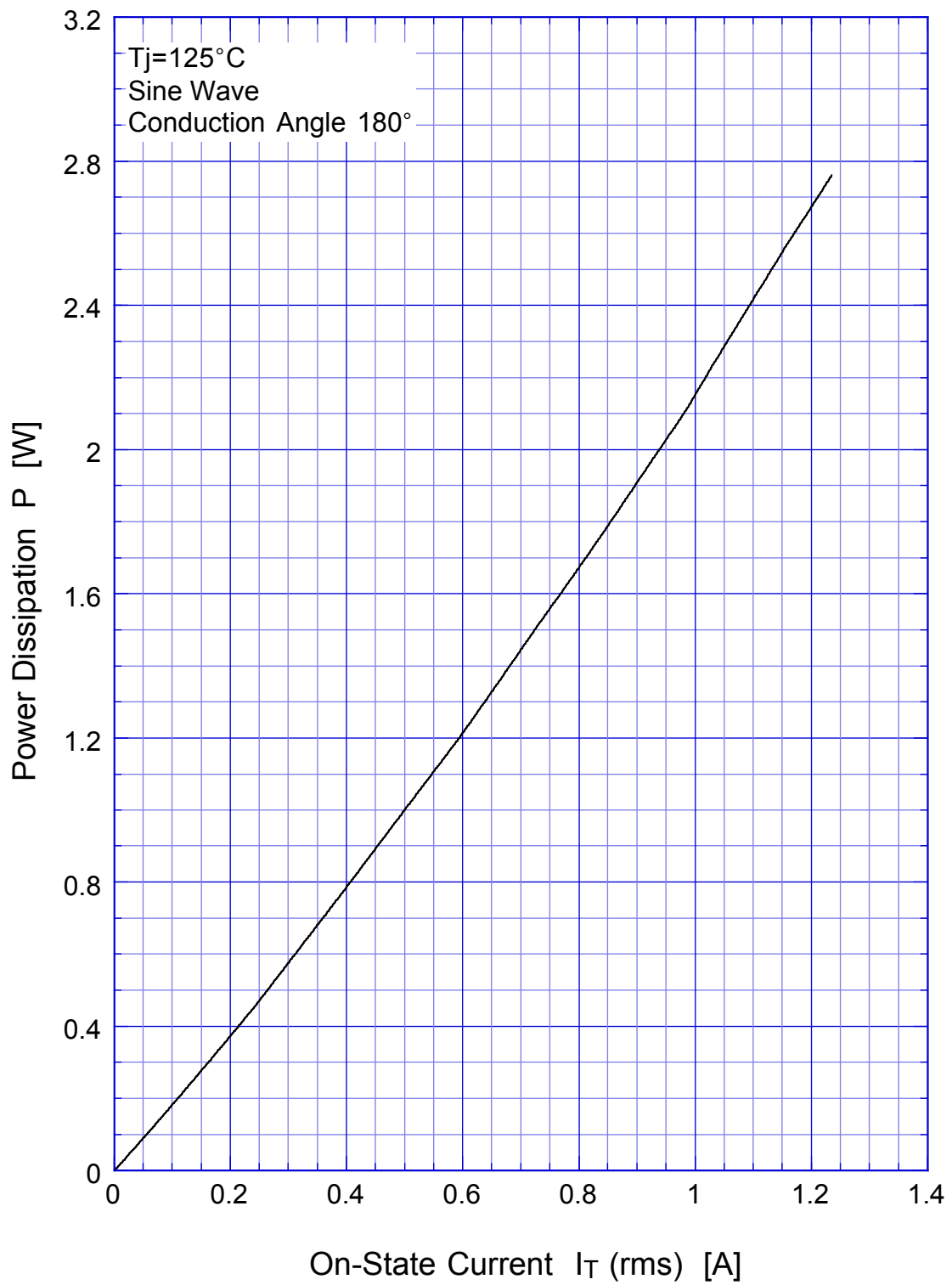

K1V33(W)  
 K1V34(W)  
 K1V36(W)  
 K1V38(W)

Transient Thermal Resistance

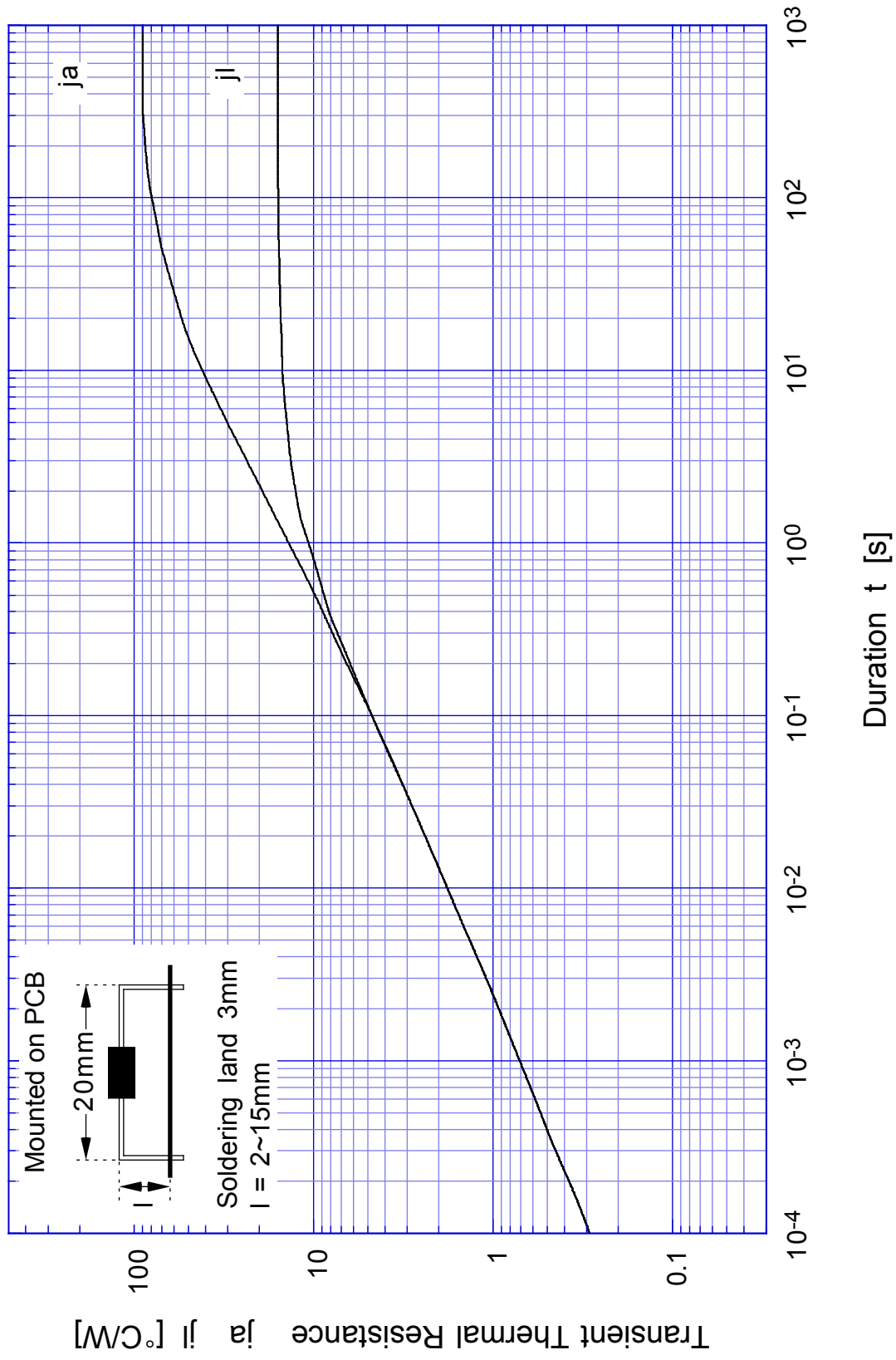

K1V33(W)  
K1V34(W)  
K1V36(W)  
K1V38(W)

Breakover Voltage - Junction Temperature

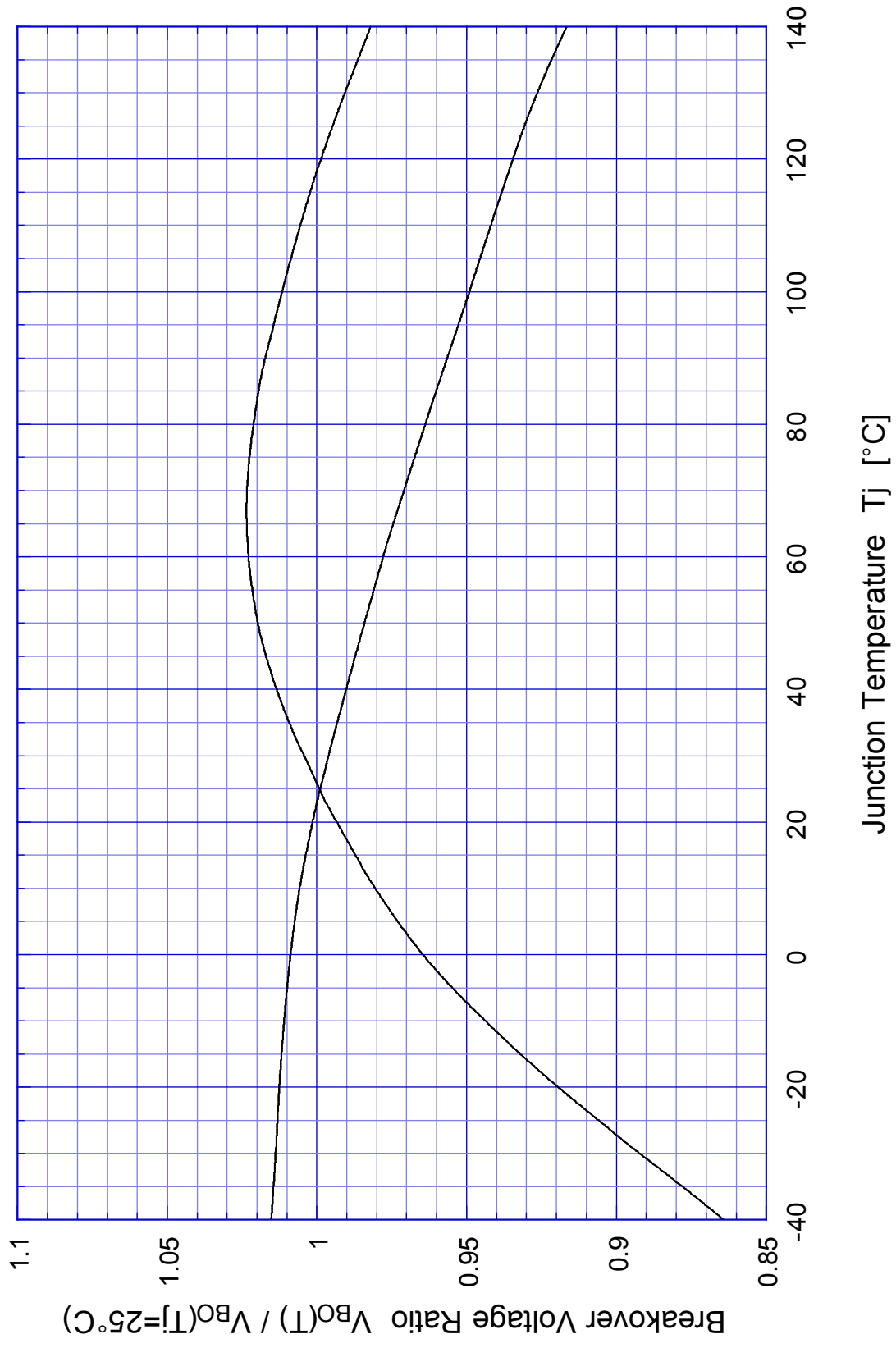

K1V33(W)

K1V34(W)

K1V36(W)

K1V38(W)

Maximum Lead Temperature

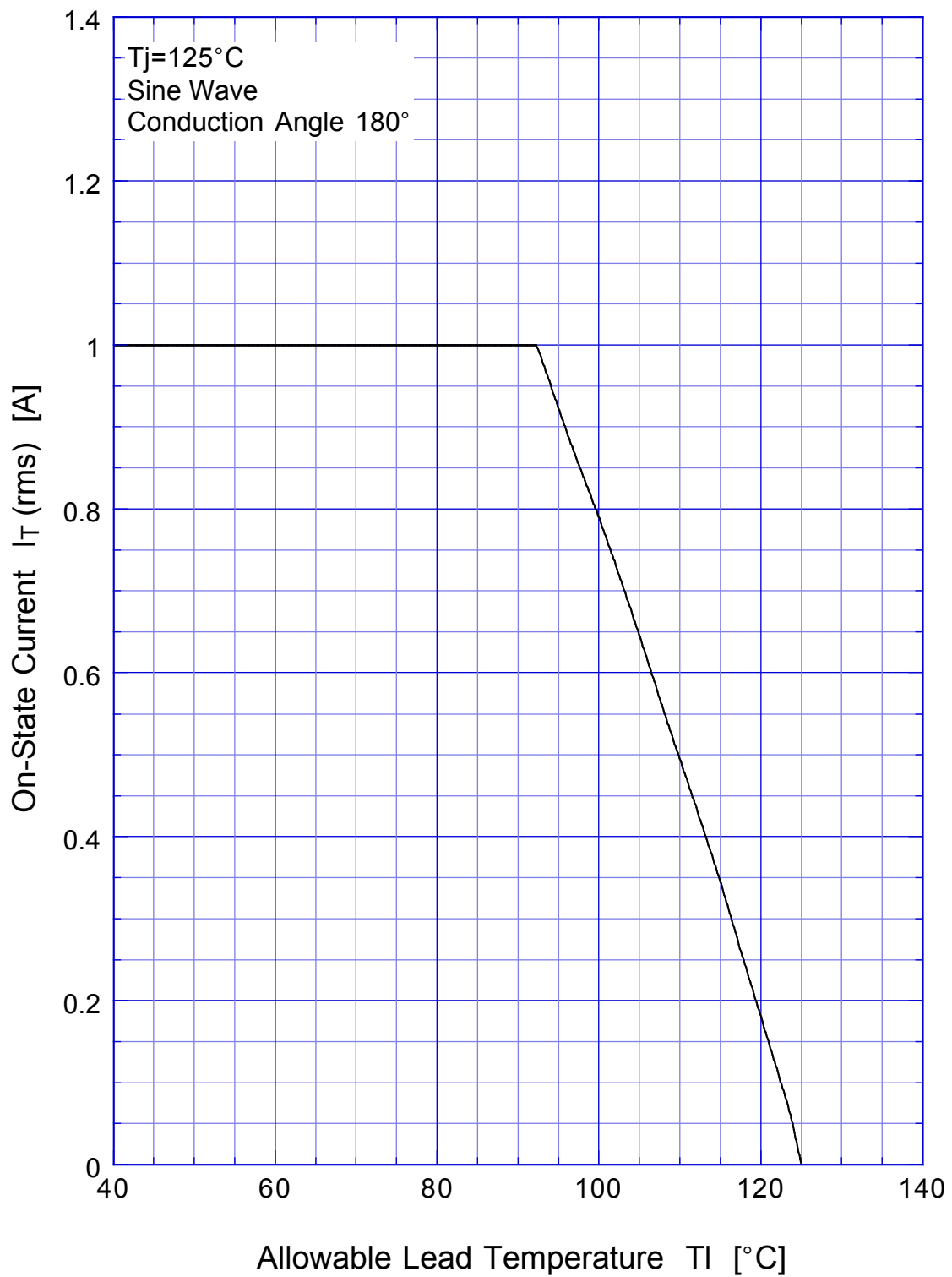

K1V33(W)  
K1V34(W)  
K1V36(W)  
K1V38(W) Maximum Ambient Temperature

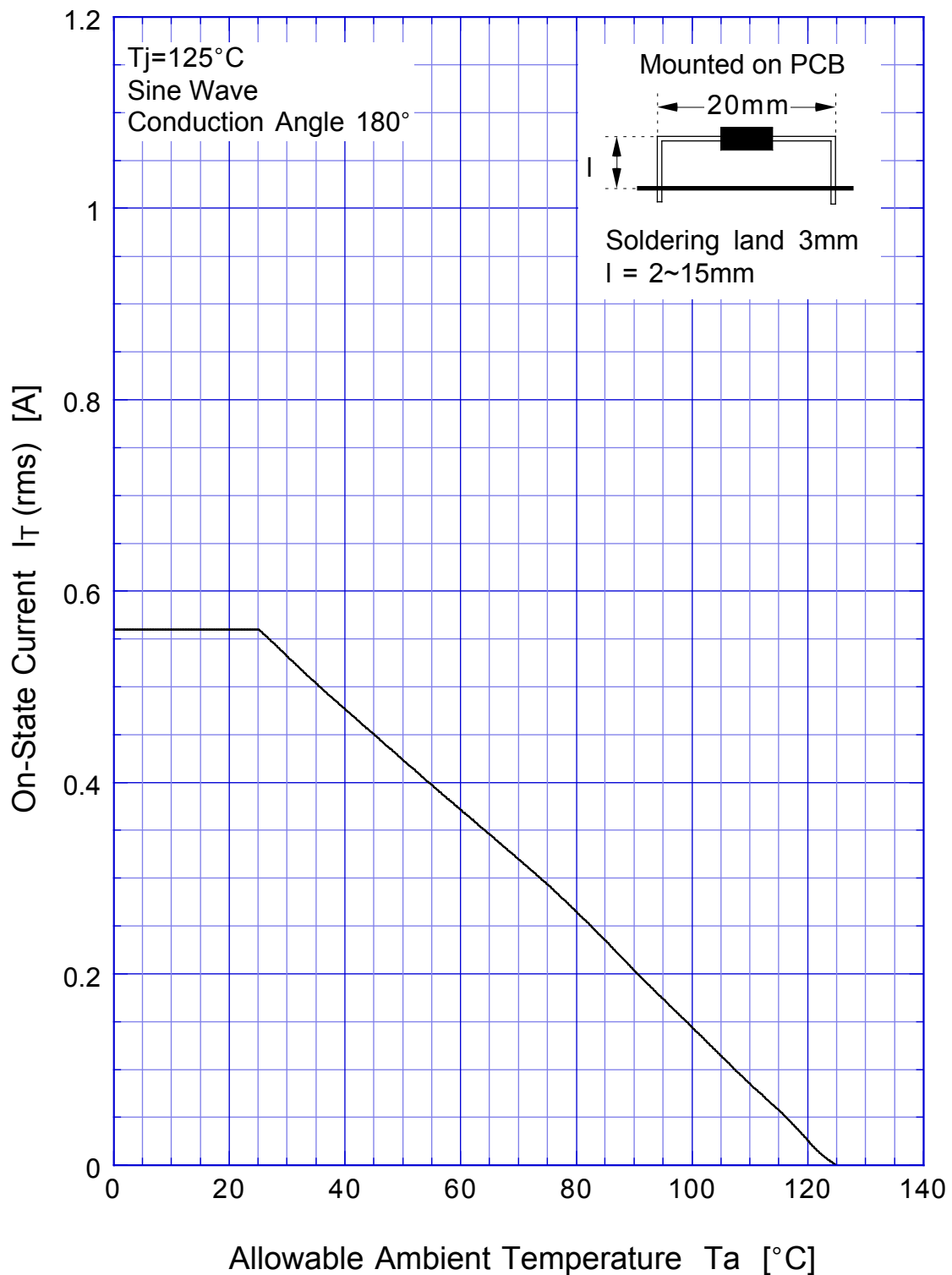

K1V33(W)  
K1V34(W)  
K1V36(W)  
K1V38(W)

Maximum Surge On-State Current

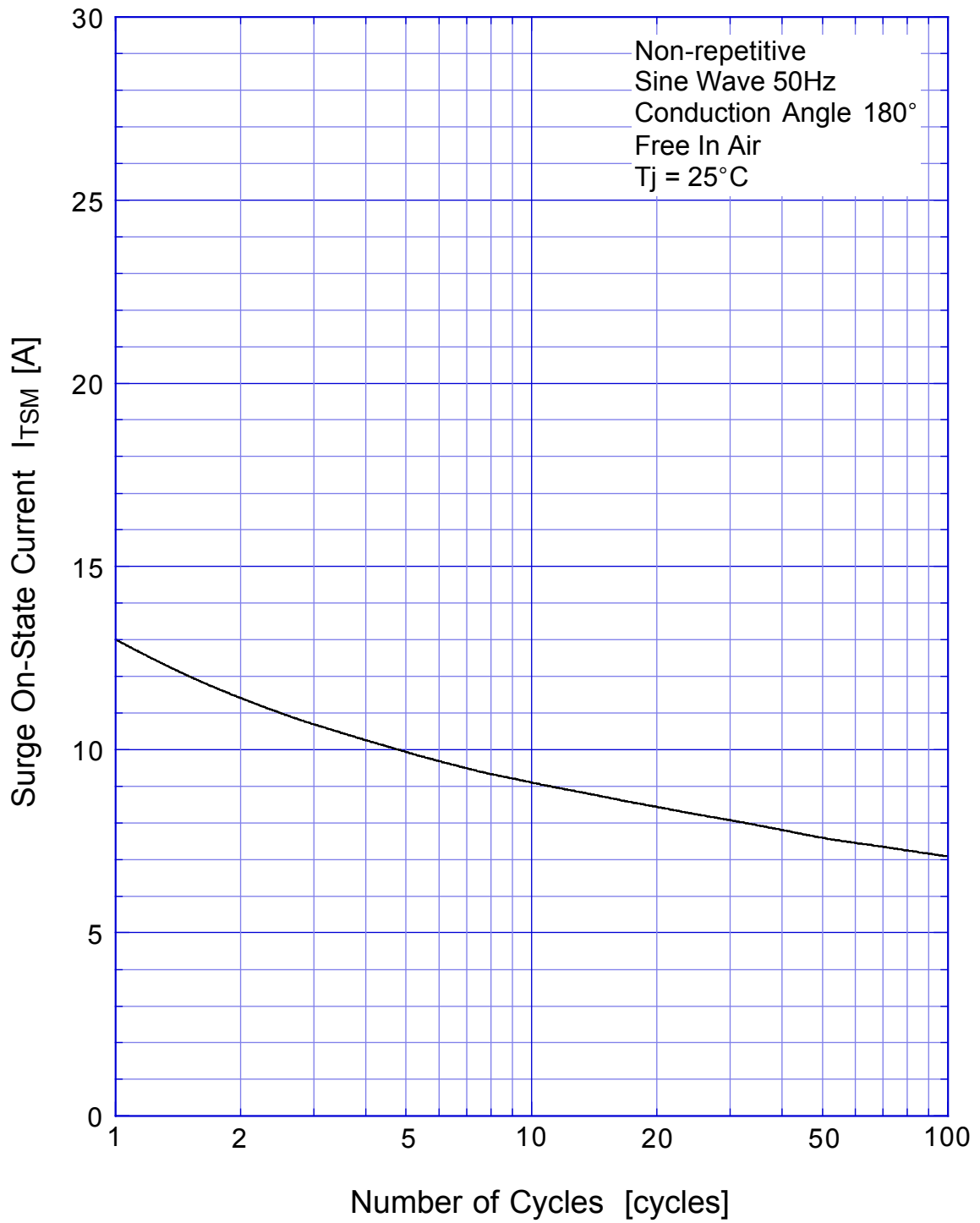



K1V33(W)  
K1V34(W)  
K1V36(W)  
K1V38(W)

### Pulse On-State Current Rating

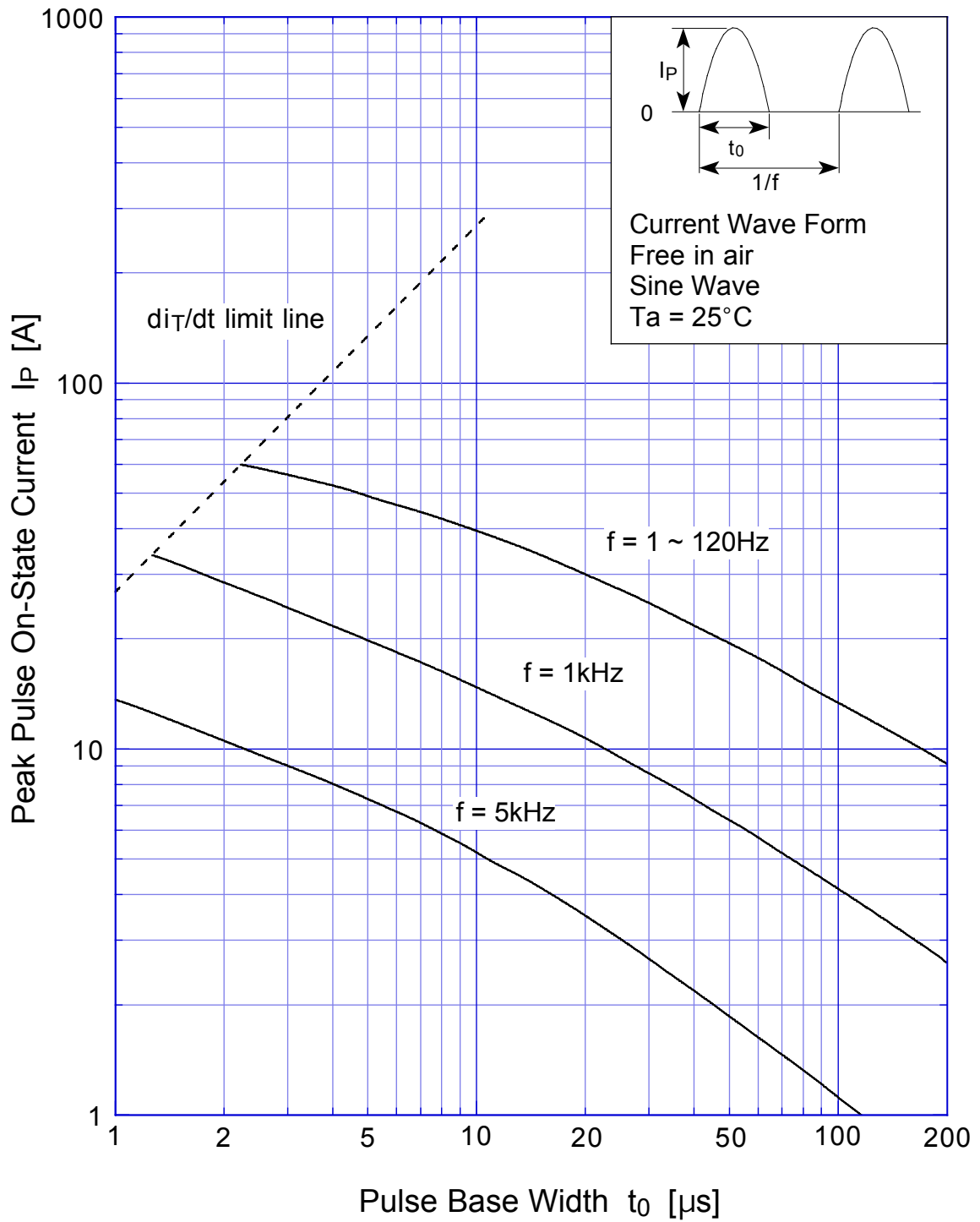

K1V33(W)

K1V34(W)

K1V36(W)

K1V38(W)

Pulse On-State Current Derating

