

# ST03D-82

### OUTLINE DIMENSIONS

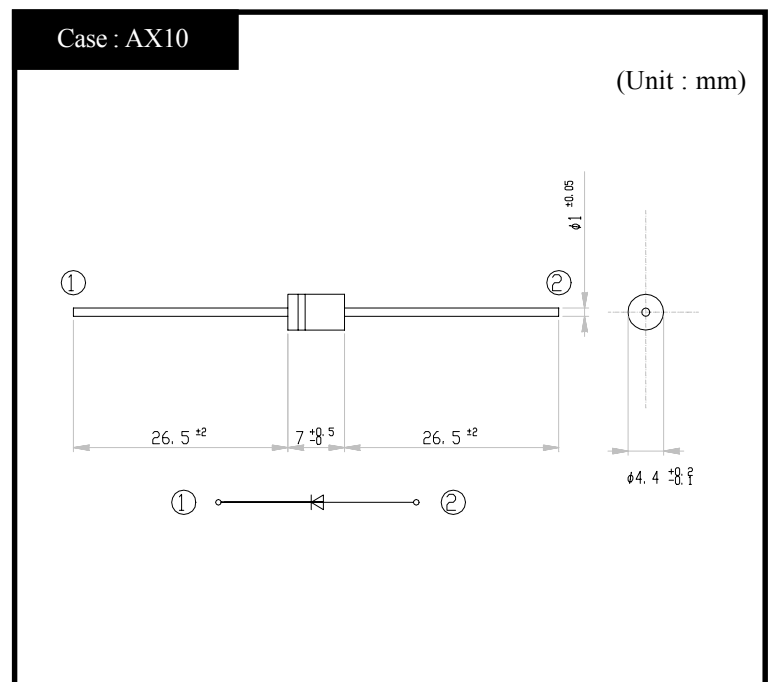

### RATINGS

#### ● Absolute Maximum Ratings (Tl=25°C)

Item	Symbol	Conditions	ZD	Di	Unit
Storage Temperature	T <sub>stg</sub>		-40~150	-40~150	°C
Junction Temperature	T <sub>j</sub>		150	150	°C
Peak Surge Reverse Power	P <sub>RSM</sub>	10/1000 μ s, Non-repetitive	300	-	W
Peak Surge Reverse Current	I <sub>RSM</sub>	10/1000 μ s, Non-repetitive	2.5	-	A
Maximum Reverse Voltage	V <sub>RM</sub>		67	600	V

#### ● Electrical Characteristics (Tl=25°C)

Item	Symbol	Conditions	ZD	Di	Unit
Movement Start Voltage	V <sub>BR</sub>	I <sub>R</sub> = 1mA	MIN 74 TYP 82 MAX 90	-	V
Restriction Voltage	V <sub>CL</sub>	I <sub>PP</sub> = 2.5A	MAX 118	-	V
Leak Current	I <sub>R</sub>	V <sub>R</sub> = V <sub>RM</sub>	MAX 5	MAX 5	μ A
Reverse Recovery Time	t <sub>rr</sub>	I <sub>F</sub> /I <sub>R</sub> =0.1A/0.3A	-	MAX 500	ns
Thermal Resistance	θ <sub>jL</sub>	Junction to lead	MAX 13	MAX 13	°C/W

# ST03D-82 Breakdown Voltage

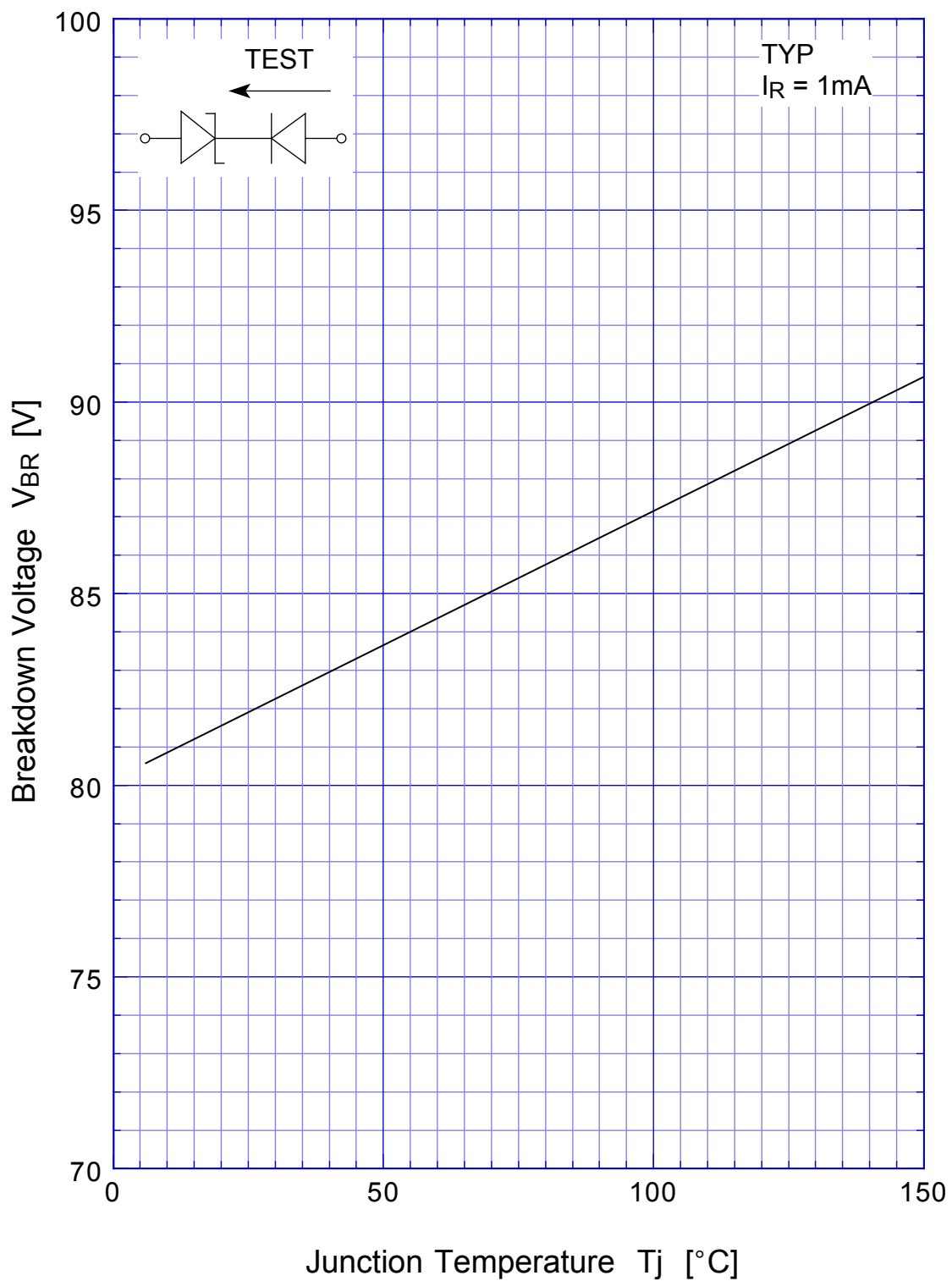

# ST03D-82

## Reverse Current

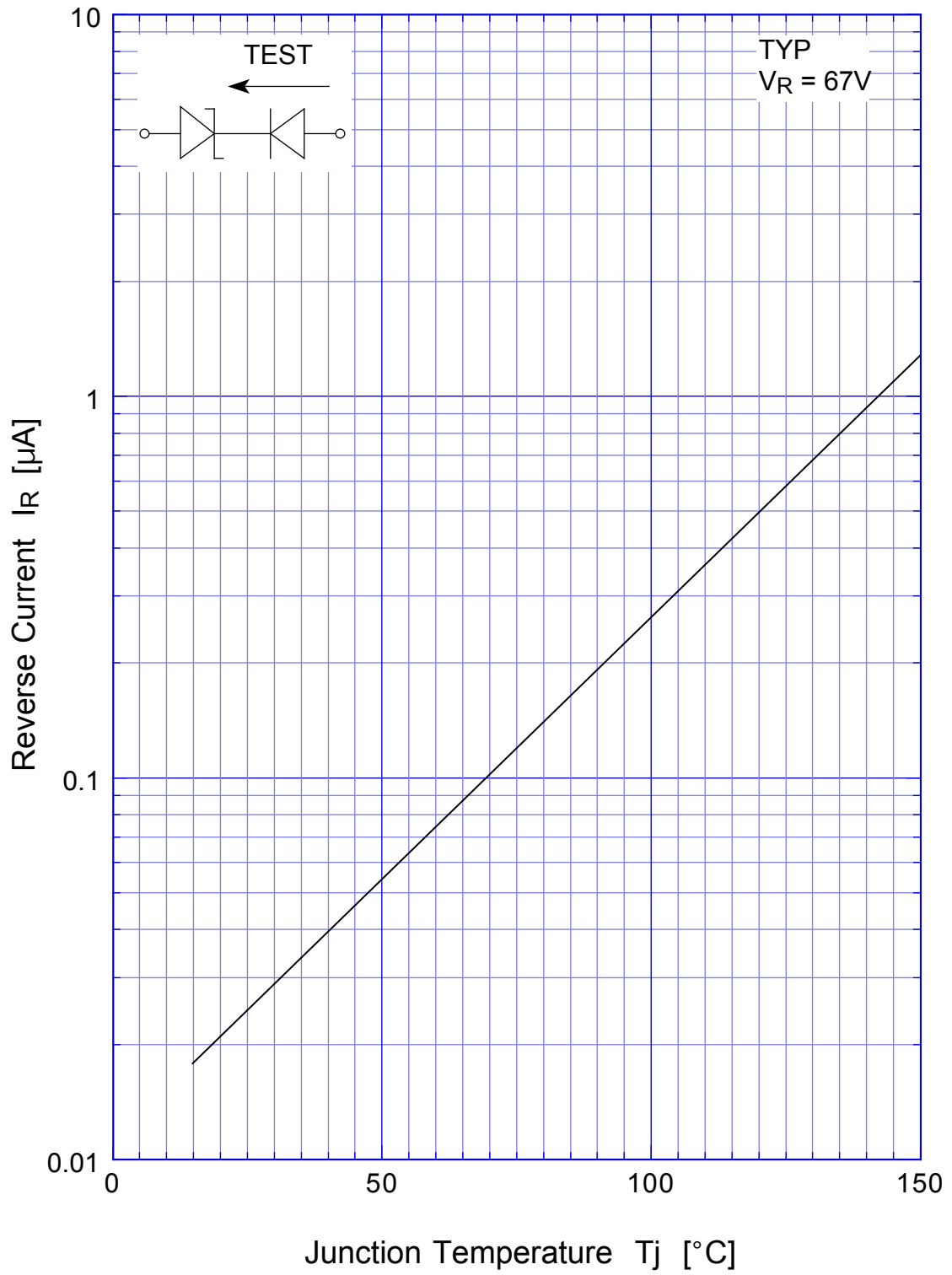

# ST03D-82 Reverse Current

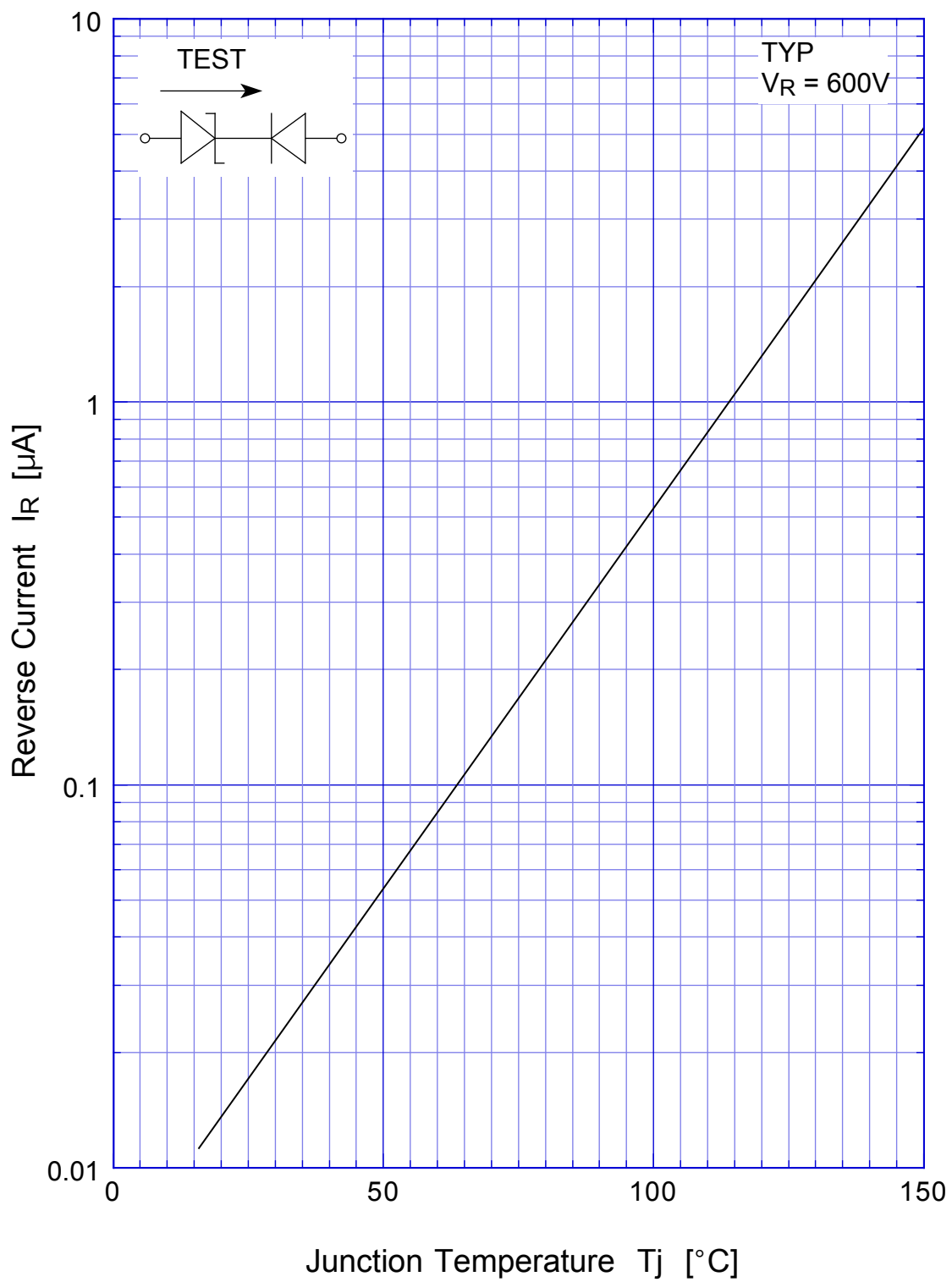

# ST03D-82

# Peak Surge Reverse Power

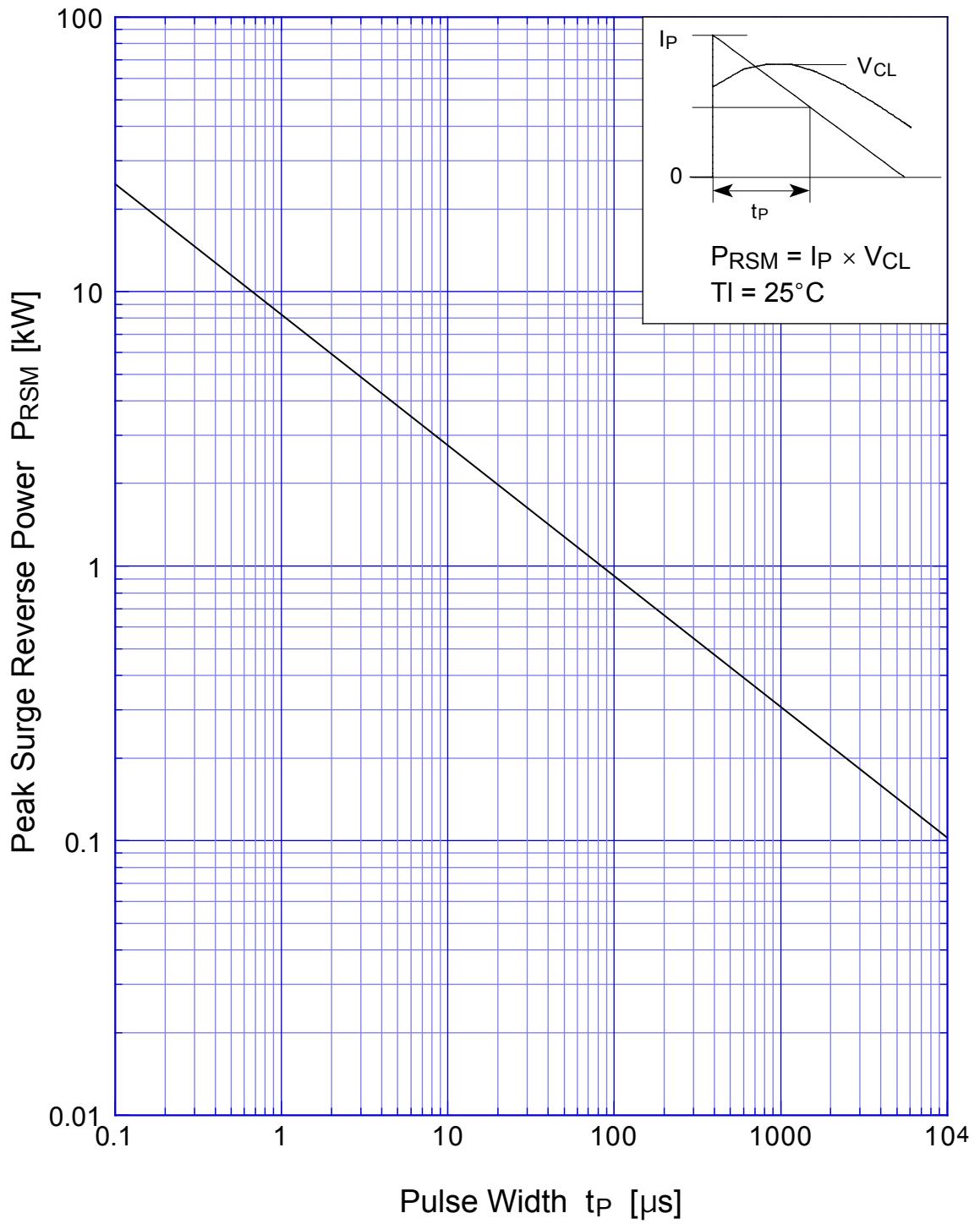

# ST03D-82 Junction Capacitance

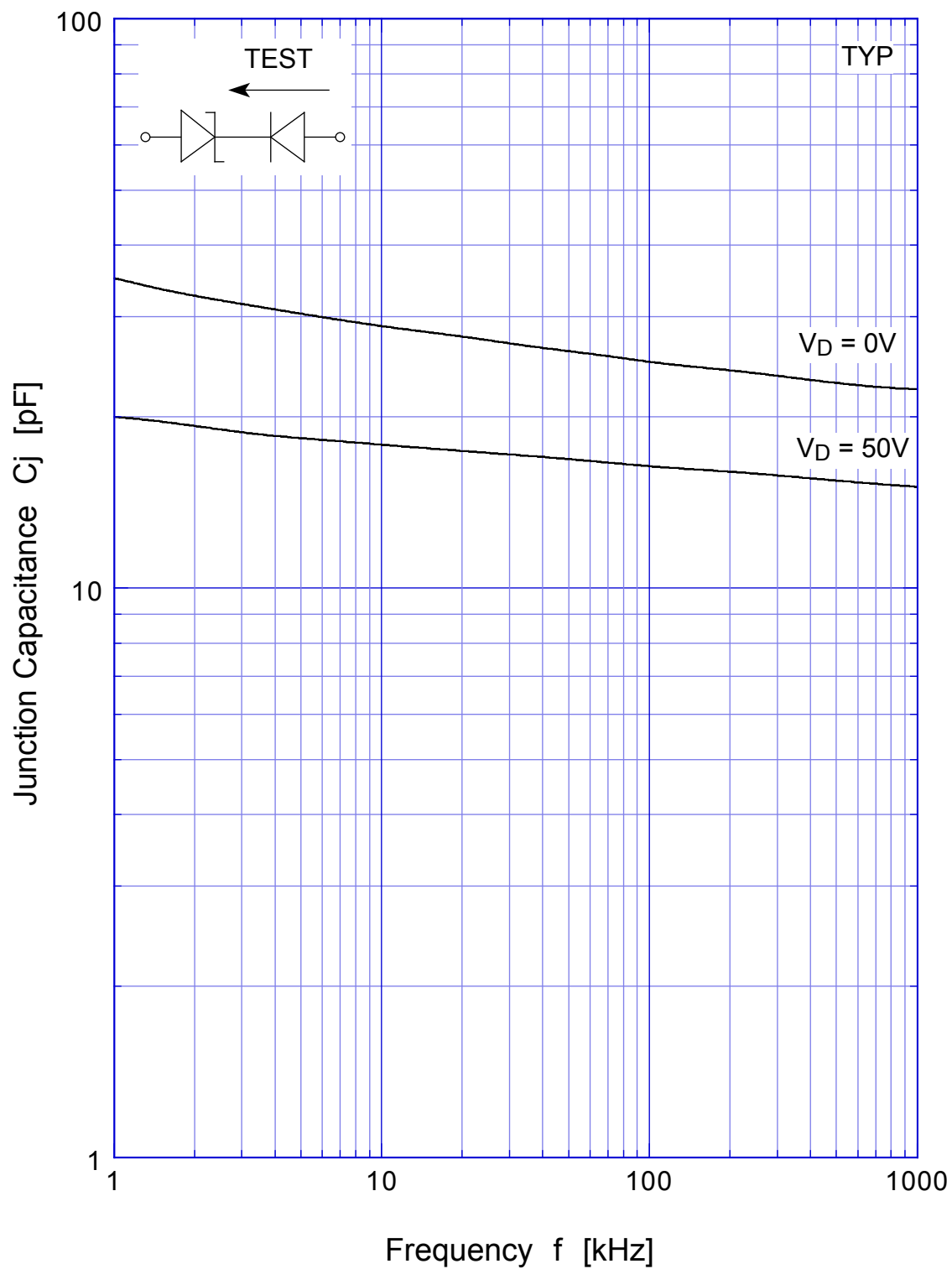

# ST03D-82 Junction Capacitance

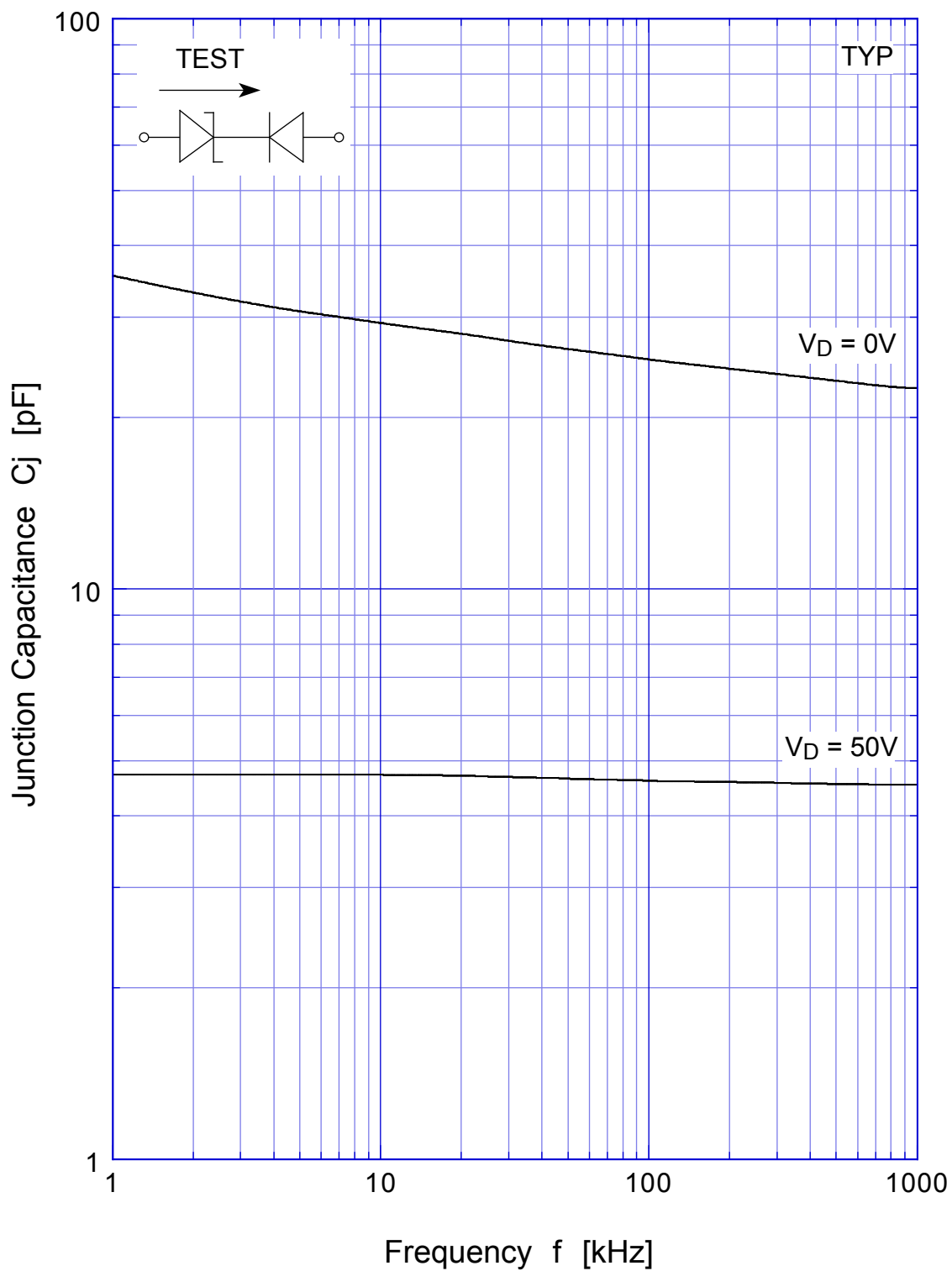

# ST03D-82

# Junction Capacitance

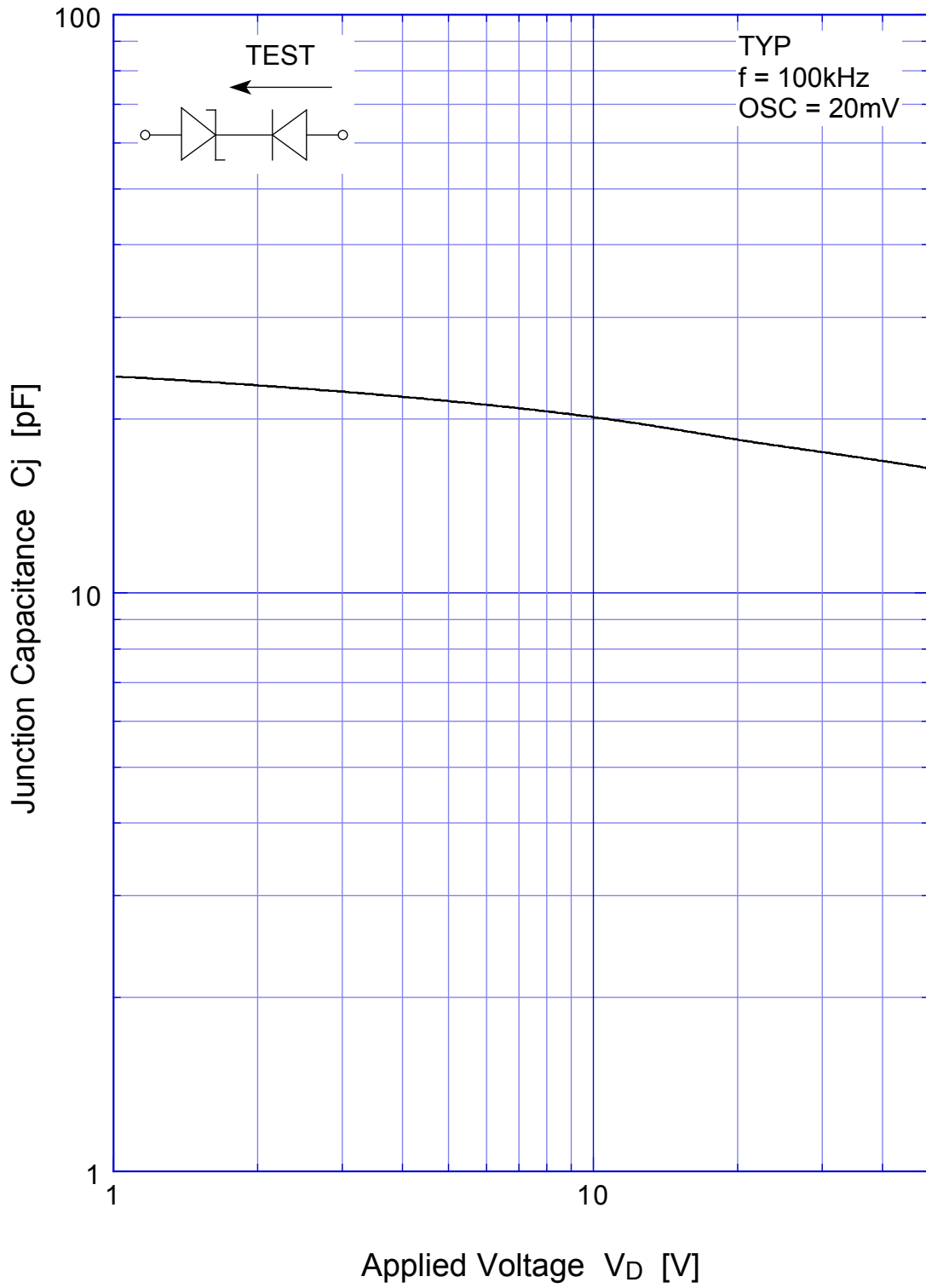



# ST03D-82

# Junction Capacitance

