

The S-24 Series is a non-volatile CMOS RAM, composed of a CMOS static RAM and a non-volatile electrically erasable and programmable memory (E²PROM) to backup the SRAM. The organization is 16-word×16-bit (total 256 bits) for the S-24H45 and the S-24S45, and 8-word×8-bit (total 64 bits) for the S-24H30 and the S-24S30.

■ Features

- 256 bits
 - S-24H45: TTL input, compatible with the X2444 of Xicor
 - S-24S45: Schmitt input for STORE and RECALL pins
- 64 bits
 - S-24H30: TTL input
 - S-24S30: Schmitt input for STORE and RECALL pins
- Non-volatile functions can be controlled by software and hardware
- Erroneous store protection : = 3.5 V
- All inputs and outputs are compatible with TTL
 - * Except STORE and RECALL pins for the S-24S Series
- +5-V single power supply (+5 V ± 10%)
- Low current consumption
 - Operating: 5 mA typ.
 - Standby : 1 μA max.
- E²PROM store cycles : 10⁵ times
- E²PROM data retention: 10 years
- 8-pin DIP/SOP package

■ Pin Assignment

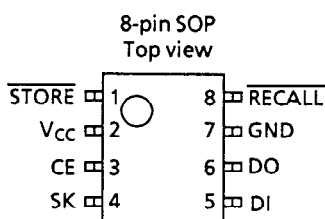
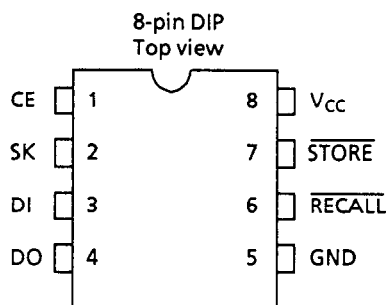

CE	Chip enable
SK	Serial clock
DI	Serial data input
DO	Serial data output
<u>RECALL</u>	Recall
<u>STORE</u>	Store
GND	Ground
V _{cc}	Power supply voltage (+ 5 V)

Figure 1

SERIAL NON-VOLATILE RAM S-24 Series

■ Block Diagram

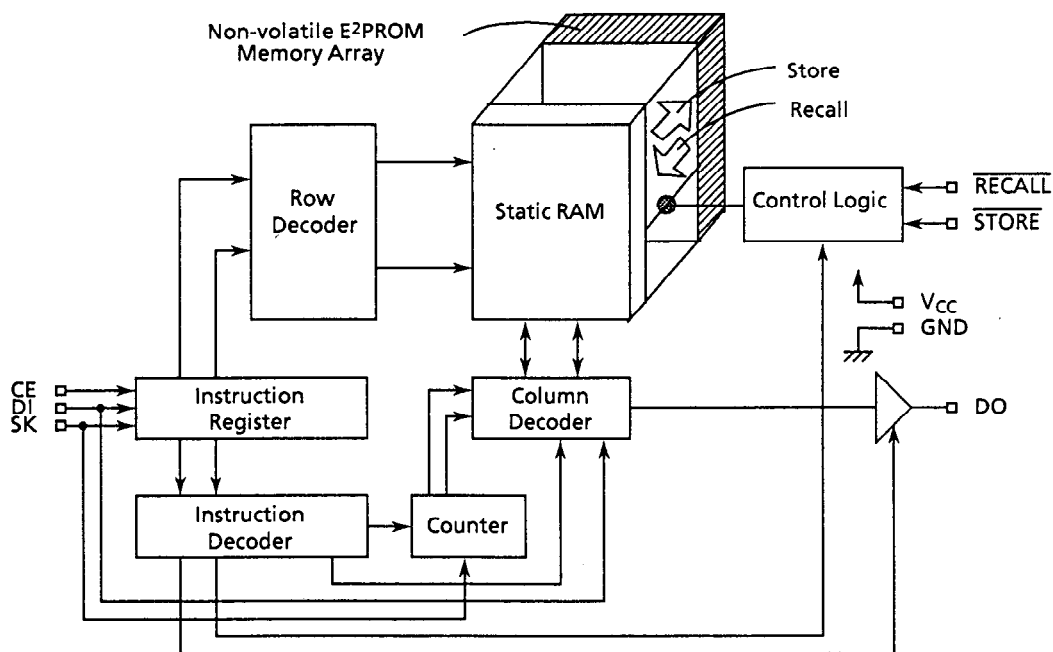

Figure 2

■ Absolute Maximum Ratings

Table 1

Parameter	Symbol	Ratings	Unit
Power supply voltage	V_{CC}	-0.3 to +6.0	V
Input voltage	V_{IN}	-0.3 to $V_{CC} + 0.3$	V
Output voltage	V_{OUT}	0.0 to V_{CC}	V
Storage temperature under bias	T_{bias}	-50 to +95	°C
Storage temperature	T_{stg}	-65 to +150	°C

■ Recommended Operating Conditions

Table 2

Parameter	Symbol	Conditions	Min.	Typ.	Max.	Unit
Power supply voltage	V_{CC}		4.5	5.0	5.5	V
High level input voltage 1	V_{IH}	S-24H Series : All inputs S-24S Series : CE, SK and DI	2.0	—	V_{CC}	V
High level input voltage 2	V_{IHS}	S-24S Series : \overline{STORE} and \overline{RECALL}	3.4	—	V_{CC}	V
Low level input voltage 1	V_{IL}	S-24H Series : All inputs S-24S Series : CE, SK and DI	0.0	—	0.8	V
Low level input voltage 2	V_{ILS}	S-24S Series : \overline{STORE} and \overline{RECALL}	0.0	—	0.8	V
Operating temperature	T_{opr}		-40	—	+85	°C

■ Pin Capacitance

Table 3

($T_a = 25^\circ\text{C}$, $f = 1.0\text{ MHz}$, $V_{CC} = 5\text{ V}$)

Parameter	Symbol	Conditions	Min.	Typ.	Max.	Unit
Input capacitance	C_{IN}	$V_{IN} = 0\text{ V}$	—	—	6	pF
Output capacitance	C_{OUT}	$V_{OUT} = 0\text{ V}$	—	—	8	pF

■ DC Electrical Characteristics

Table 4

(Ta = -40°C to 85°C, V_{CC} = +5 V ± 10%)

Parameter	Symbol	Conditions	Min.	Typ.	Max	Unit
Operating current consumption	I _{CC}	DO unloaded	—	5	10	mA
Sleep current	I _{SL}	All inputs are V _{CC}	—	—	1	μA
Standby current	I _{SB}	CE = GND, Other inputs are V _{CC}	—	—	1	μA
Store current	I _{STO}		—	5	10	mA
Input leakage current	I _{LI}	V _{IN} = GND to V _{CC}	—	0.1	1	μA
Output leakage current	I _{LO}	V _{OUT} = GND to V _{CC}	—	0.1	1	μA
Low level output voltage	V _{OL}	CMOS : I _{OL} = 100 μA	—	—	0.1	V
		TTL : I _{OL} = 2.1 mA	—	—	0.4	V
High level output voltage	V _{OH}	CMOS : I _{OH} = -100 μA	V _{CC} -0.1	—	—	V
		TTL : I _{OH} = -400 μA	2.4	—	—	V
Store inhibition voltage	V _{WI}		—	3.5	4.2	V
Schmitt width	V _{WD}	S-24S Series : STORE and RECALL	0.4	—	—	V

■ Data Hold Characteristics

Table 5

Parameter	Symbol	Conditions	Min.	Typ.	Max	Unit
Data hold voltage	V _{DH}	CE ≤ 0.2V, RECALL ≥ V _{CC} -0.2V	1.5	—	5.5	V
Data hold setup time	t _{CDH}		50	—	—	ns
Recovery time	t _R		300	—	—	ns

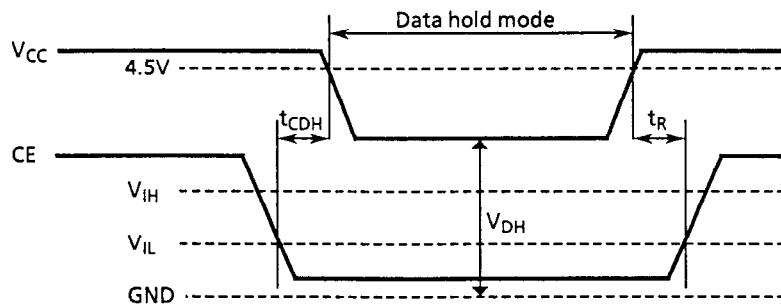

Figure 3 Data hold timing chart

■ AC Electrical Characteristics

Table 6 Measuring conditions

Parameter	Conditions	
Input pulse voltage	S-24H Series : All inputs	0.0 to 3.0 V
	S-24S Series : CE, SK and DI	
	S-24S Series : STORE and RECALL	0.0 to 4.0 V
Input pulse rise/fall time		10 ns
I/O reference voltage		1.5 V
Output load		1TTL + 100pF

1. Data input/output timing

Table 7

Parameter	Symbol	Min.	Typ.	Max	Unit
SK frequency	f_{SK}	—	—	1	MHz
SK high level pulse width	t_{SKH}	0.4	—	—	μs
SK low level pulse width	t_{SKL}	0.4	—	—	μs
Input data setup time	t_{DS}	0.4	—	—	μs
Input data hold time	t_{DH}	0.08	—	—	μs
SK data valid time	t_{PD}	—	—	0.3	μs
Output disable time	t_{HZ}	—	—	1.0	μs
CE setup time	t_{CES}	0.8	—	—	μs
CE hold time	t_{CEH}	0.4	—	—	μs
CE deselect time	t_{CDS}	0.8	—	—	μs

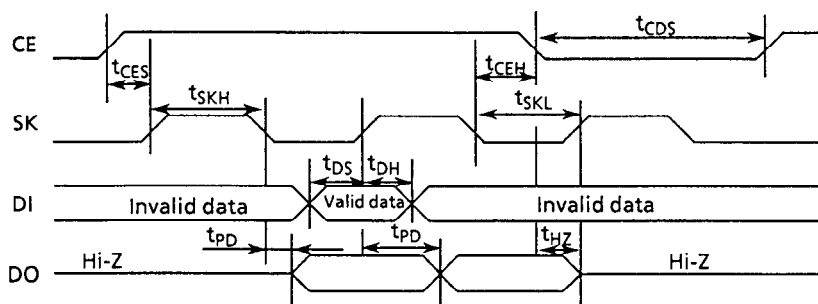

- CE must be kept high during instructions.
- When SK rises after selecting CE, the first 1 is taken into DI input and the fetch of an instruction starts. All previous 0 is ignored.

Figure 4 Control data timing

2. Recall Cycle

Table 8

Parameter	Symbol	Min.	Typ.	Max	Unit
Recall cycle time	t_{RCC}	2500	—	—	ns
Recall pulse width	t_{RCP}	500	—	—	ns
Recall disable time	t_{RCZ}	—	—	500	ns
Recall enable time	t_{ORC}	10	—	—	ns
Recall data access time	t_{ARC}	—	—	1000	ns

* Recall times are not limited.

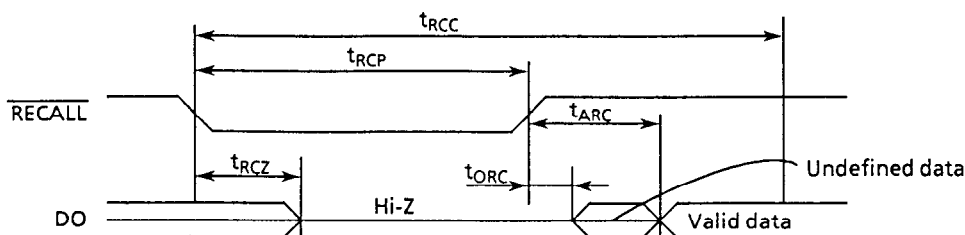

Figure 5 Hardware recall

3. Store Cycle

Table 9

Parameter	Symbol	Min.	Typ.	Max	Unit
Store time	t_{ST}	—	—	10	ms
Store pulse width	t_{STP}	0.2	—	—	μs
Store disable time	t_{STZ}	—	—	1.0	μs

Store times: 10^5 times
Data retention : 10 years

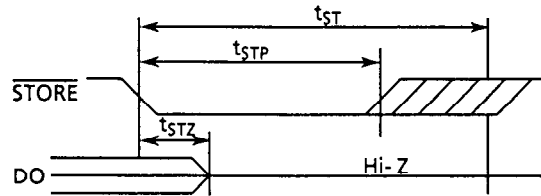

Figure 6 Hardware store

■ **Instruction Set**

Table 10

Instruction	Symbol	Format $l_2 l_1 l_0$	Function
Write enable latch reset	WRDS	1XXXX000	Reset write enable latch (Disable write and store)
Write enable latch set	WREN	1XXXX100	Set write enable latch (Enable write and store)
Read	READ	1AAAA11X	Read data from RAM address AAAA
Write	WRITE	1AAAA011	Write data into RAM address AAAA
Store	STO	1XXXX001	Store RAM data in E ² PROM
Recall	RCL	1XXXX101	Recall E ² PROM data into RAM
Sleep	SLEEP	1XXXX010	Enter sleep mode

X : Don't care
A : Address bit

- The format is composed of a start bit(1), address($A_3 A_2 A_1 A_0$) and an instruction($l_2 l_1 l_0$).
- Address A_0 is "X" for the S-24H30 and the S-24S30.

■ **Operation**

1. Internal latches

The S-24 Series has two latches, one of which controls write operation of the SRAM, and both of which control permission/inhibition of store operation of the E2PROM.

1.1 Previous recall latch

The previous recall latch controls permission/inhibition of store operation of E2PROM. It is reset when the power is turned on, and it inhibits store operation of the E2PROM. It is set by executing the software recall instruction or hardware recall, and it permits store operation of the E2PROM.

1.2 Write enable latch

The write enable latch controls permission/inhibition of both store operation of the E2PROM and write operation of the SRAM. It is reset when the power is turned on or by executing WRDS instruction, and it inhibits both store operation of the E2PROM and write operation of the SRAM.

It is set by executing WREN instruction, and it permits both store operation of the E2PROM and write operation of the SRAM.

When store operation of the E2PROM is completed, the write enable latch is automatically reset. Therefore, in order to execute store operation again, it is necessary to execute WREN instruction and to set the write enable latch.

1.3 Both the previous recall latch and the write enable latch must be set for permission of store operation.

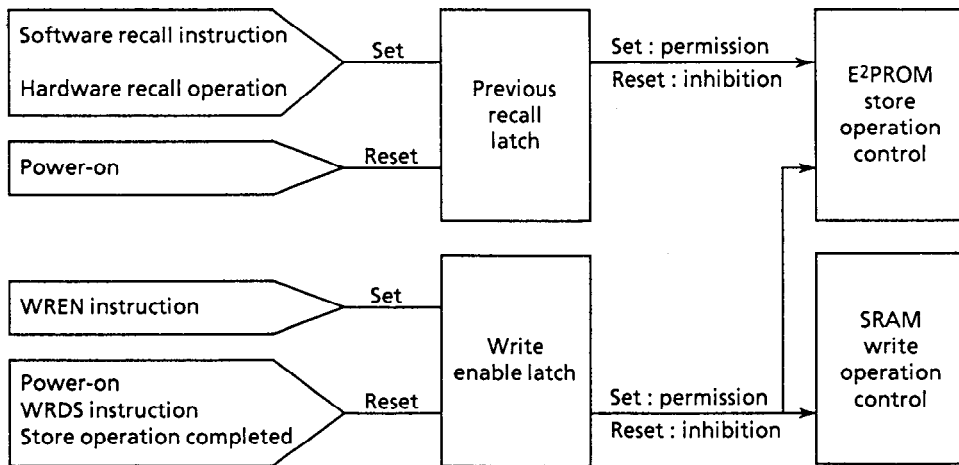

Figure 7 Internal latch

2. SRAM mode

2.1 Read

The data is read from the SRAM through READ instruction. Inputting a start bit, address and instruction code causes data output on DO. In the S-24 Series, a bi-directional serial interface can be made by connecting DI and DO. See Figures 8 and 9 for the timing.

2.2 Write

The data is written into the SRAM through WRITE instruction. Input data on DI after a start bit, address and instruction code. See Figures 10 and 11 for the timing. The write enable latch must be set before WRITE instruction.

3. E2PROM mode

Data is input to and output from the E2PROM through the SRAM.

3.1 Store

The SRAM data is copied into the E2PROM when STO instruction is executed or $\overline{\text{STORE}}$ goes low. The SRAM data does not change after STO instruction. Since the data stored in the E2PROM is non-volatile, it is retained even if power is turned off. In the case that store operation is performed while data is output on DO and during read operation of the SRAM, DO becomes high-impedance. During store operation, all other operations are inhibited.

Both the previous recall latch and the write enable latch must be set before store operation.

3.2 Recall

The E2PROM data is recopied into the SRAM when $\overline{\text{RECALL}}$ goes low or RCL instruction is executed. In the case that recall operation is performed while data is output on DO and during read operation of SRAM, DO becomes high-impedance. During recall operation, all other operations are inhibited.

4. Sleep mode

Executing SLEEP instruction disables operation of the SRAM. The E2PROM data is retained. The sleep mode can be released by recall operation.

Since the S-24 Series is in standby status and the current consumption is low when CE is at GND level, it is not necessary to execute SLEEP instruction in order to reduce the current consumption while not operating.

5. Operation timing

After CE rose, when SK clock rises and DI goes high, a start bit is recognized and the fetch of an instruction starts. Data is fetched to DI terminal at the rise of SK clock.

5.1 Read

DO is output at the fall of the 8th clock, and others are output at the rise of the clock.

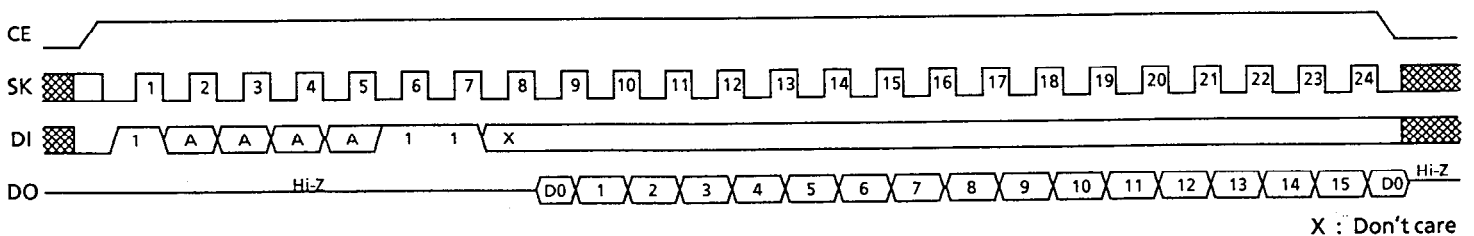

Figure 8 Read mode timing(S-24H45, S-24S45)

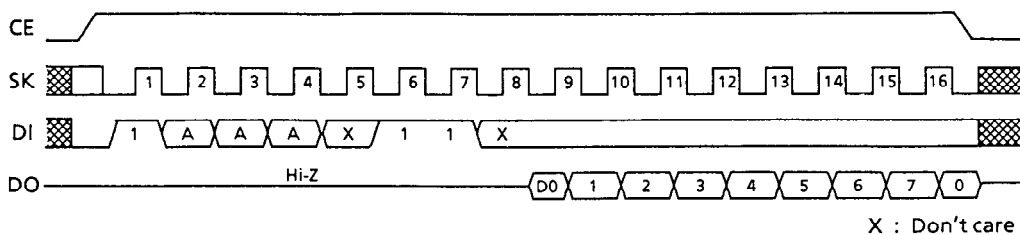

Figure 9 Read mode timing(S-24H30, S-24S30)

SERIAL NON-VOLATILE RAM S-24 Series

5.2 Write

Data is written to the SRAM at the rise of SK clock.

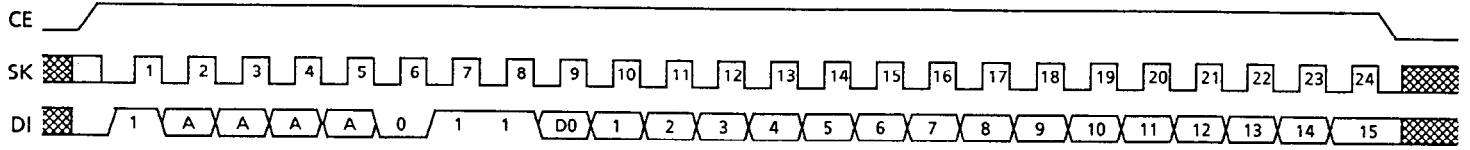

Figure 10 Write mode timing(S-24H45, S-24S45)

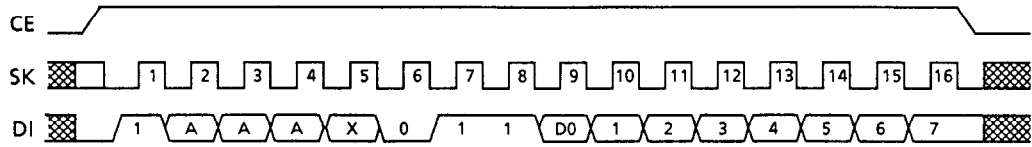

Figure 11 Write mode timing(S-24H30, S-24S30)

5.3 Other operation modes

CE must be low between instructions.

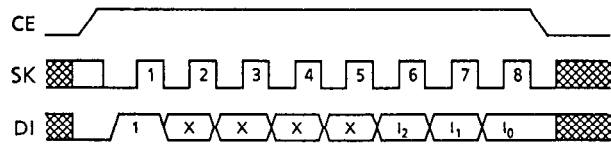

Figure 12 Other operation modes timing

Interface with CPU with Serial Port

- When SK and DI are high at the rise of CE, high of DI is regarded as a start bit and the clock 1 generates and the high of DI is fetched. When DI is low, DI is not regarded as a start bit until DI becomes high at the rise of SK.
- After power on or after an instruction is performed, DI must be set 1 for preparing the fetch of the start bit of the next instruction.

Figures 13 to 17 show the timings of write/read, and other operation modes, and interfacing examples are shown in Figures 18 to 20.

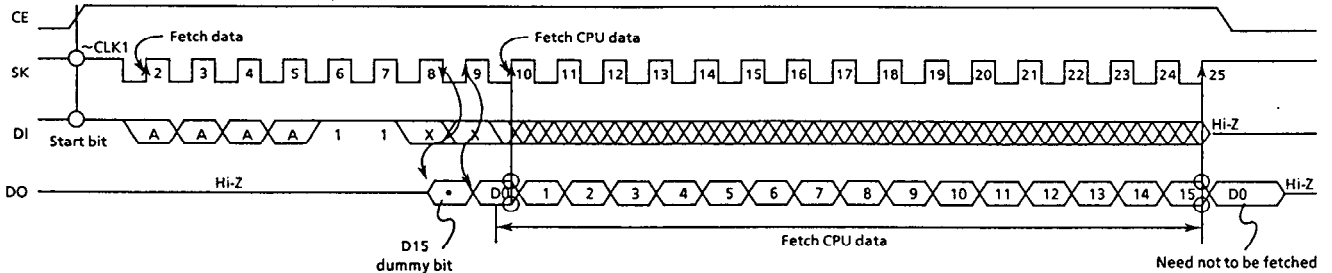

Figure 13 Read mode timing(S-24H45, S-24S45)

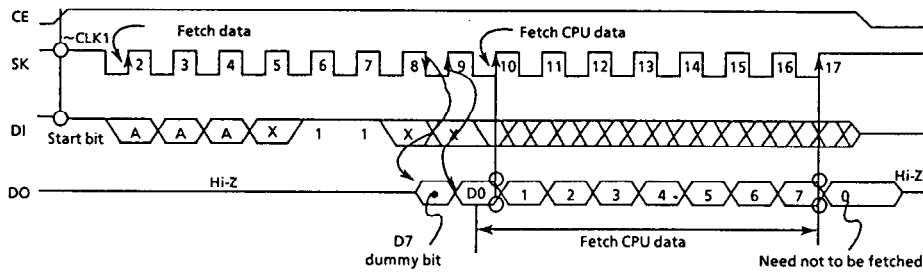

Figure 14 Read mode timing(S-24H30, S-24S30)

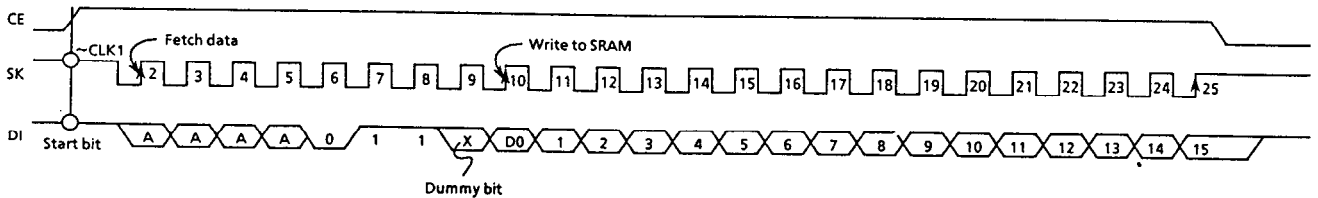

Figure 15 Write mode timing(S-24H45, S-24S45)

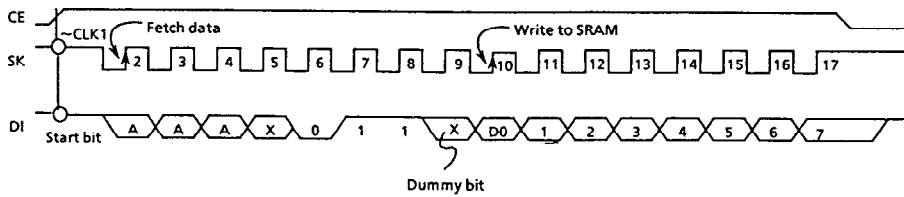
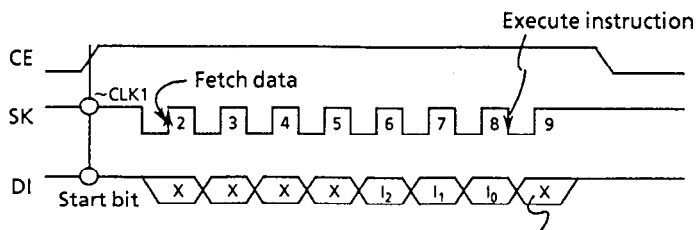

Figure 16 Write mode timing(S-24H30, S-24S30)



Dummy bit: Recommended to be set to 1 for fetching the start bit of next instruction

Figure 17 Other operation mode timing

SERIAL NON-VOLATILE RAM S-24 Series

Interfacing example 1 : With Intel 8051, 8052

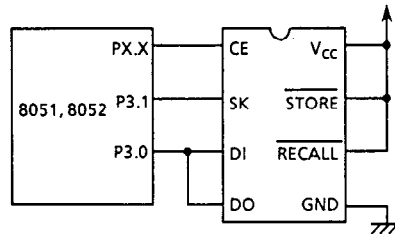

Figure 18

Interfacing example 2 : With other CPU

When the S-24 Series is connected to CPU other than Intel 8051 and 8052, delay circuit should be set by a capacitor and a resistor at DO terminal (Figure 19), delaying the signal more than 200 ns as in Figure 20 to assure the data hold time (t_{DHU}) and the data setup time (t_{DSU}) of CPU.

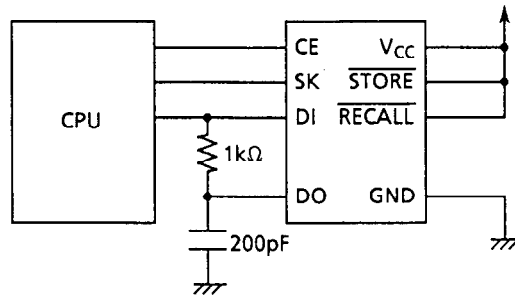

Figure 19

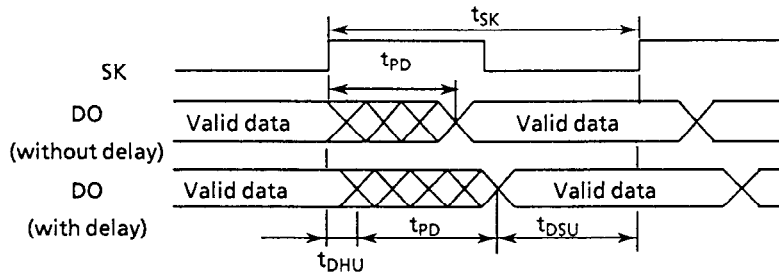

Figure 20

The maximum speed of the SK clock (f_{SKMAX}) is expressed by the following formula:

$$f_{SKMAX} = \frac{1}{t_{SK}} = \frac{1}{t_{DSU} + t_{DHU} + t_{PD\ max}}$$

For example, when interfacing with NEC μ PD75XX series, f_{SKMAX} is as follows:

μ PD75XX series t_{DSU} : 300 ns min.

t_{DHU} : 450 ns min.

S-24 Series t_{PD} : 0 ns min. , 300 ns max.

$$f_{SKMAX} = \frac{1}{t_{SK}} = \frac{1 \times 10^9}{300 + 450 + 300} = \frac{1}{1.05 \mu s} = 952 \text{ kHz}$$

■ Dimensions (Unit:mm)

1. 8-pin DIP

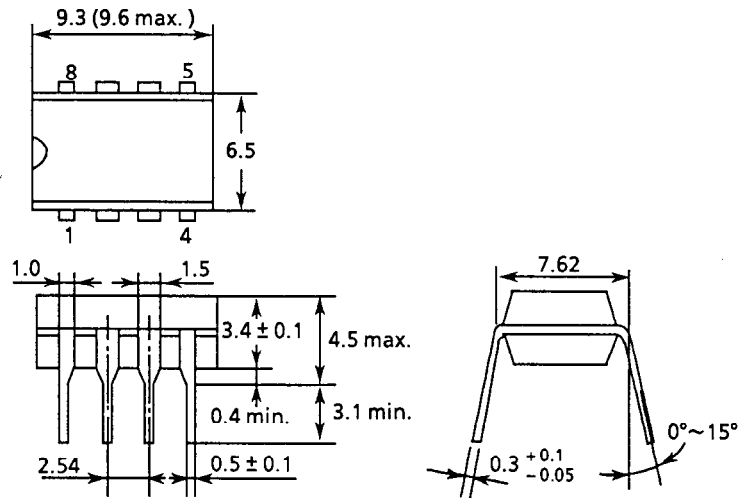

Figure 21

2. 8-pin SOP

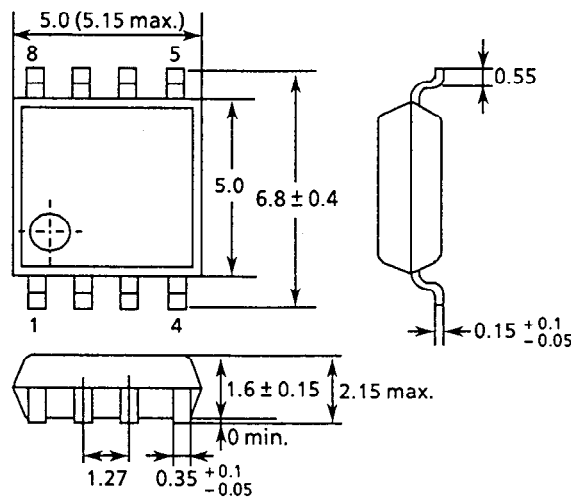

Figure 22

■ Ordering Information

S-24	XX	X	X	XX	
					Rewriting times
					Package
					Temperature
					Memory size
					Input level
					10 : 10 ⁵ times
					Blank: DIP
					F : SOP
					I : -40°C to 85°C
					30 : 64-bit
					45 : 256-bit
					H : All pins TTL compatible
					S : Schmitt input for <u>STORE</u> and <u>RECALL</u>

**SERIAL NON-VOLATILE RAM
S-24 Series**

■ **Characteristics**

1. DC Characteristics

1.1 Operating current consumption I_{CC} — Ambient temperature T_a

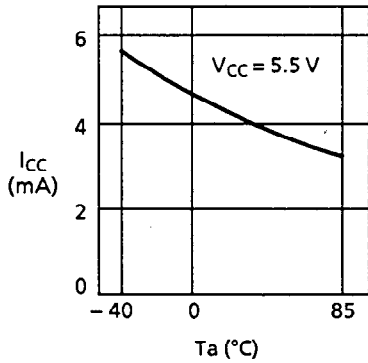

1.2 Operating current consumption I_{CC} — Power supply voltage V_{CC}

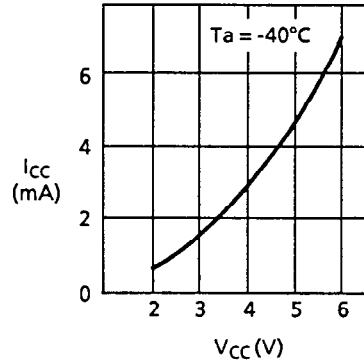

1.3 Operating current consumption I_{CC} — SK frequency f_{SK}

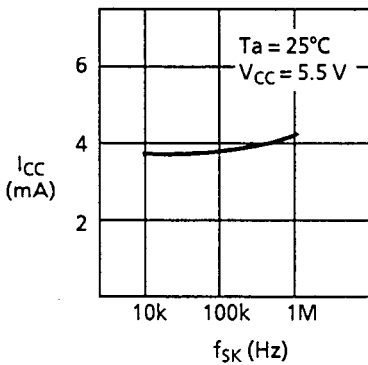

1.4 Sleep/standby current consumption I_{SL}/I_{SB} — Ambient temperature T_a

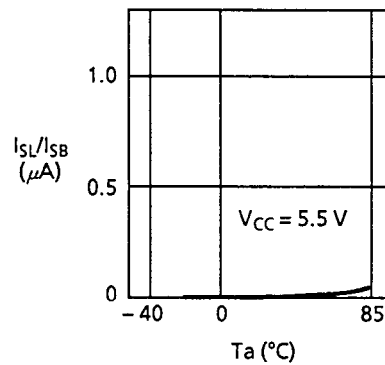

1.5 Store current consumption I_{STO} — Ambient temperature T_a

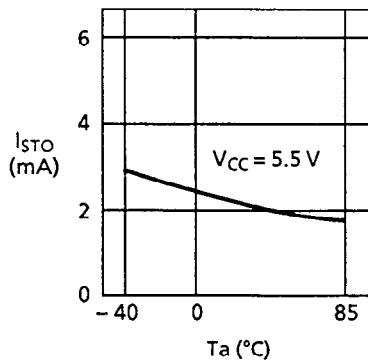

1.6 Store current consumption I_{STO} — Power supply voltage V_{CC}

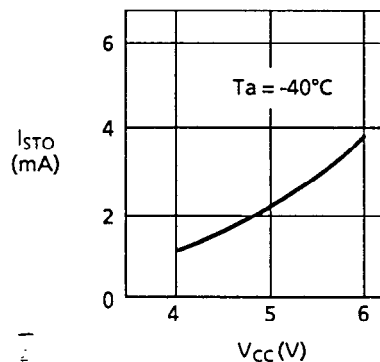

1.7 Store inhibition voltage V_{WI} — Ambient temperature T_a

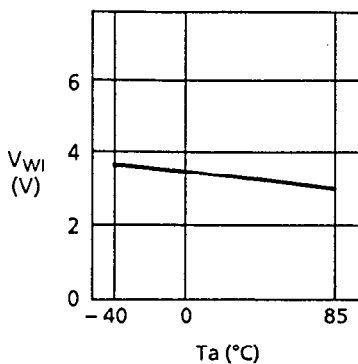

1.8 Input voltage V_{IN} — Ambient temperature T_a
S-24H Series : All inputs
S-24S Series : CE, SK and DI

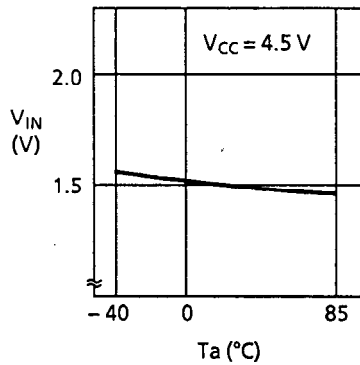

1.9 Input voltage V_{IN} — Power supply voltage V_{CC}
S-24H Series : All inputs
S-24S Series : CE, SK and DI

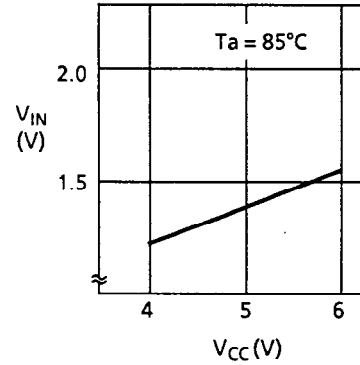

1.10 Input voltage V_{IN} — Ambient temperature T_a
S-24S Series : STORE and RECALL

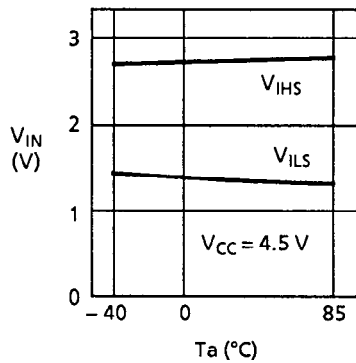

1.11 Input voltage V_{IN} — Power supply voltage V_{CC}
S-24S Series : STORE and RECALL

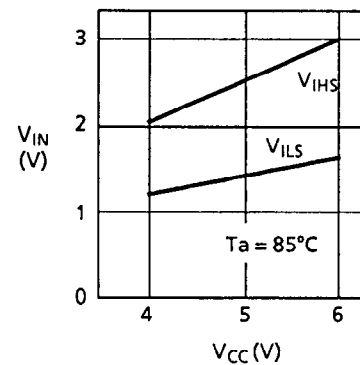

1.12 High level output current I_{OH} — Ambient temperature T_a

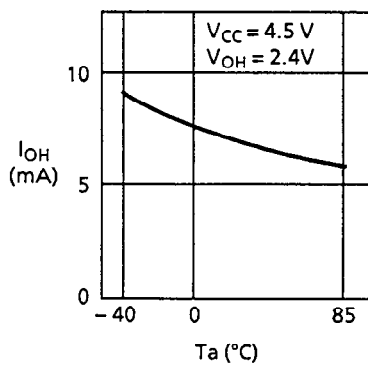

1.13 Low level output current I_{OL} — Ambient temperature T_a

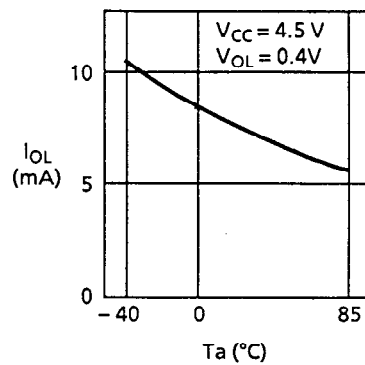

1.14 High level output voltage V_{OH} — Ambient temperature T_a

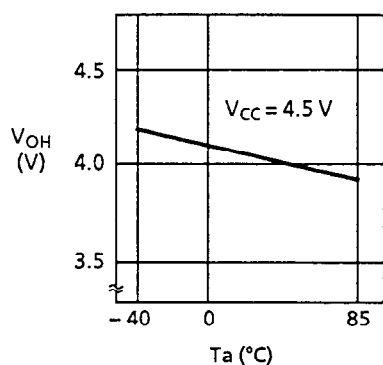

1.15 Low level output voltage V_{OL} — Ambient temperature T_a

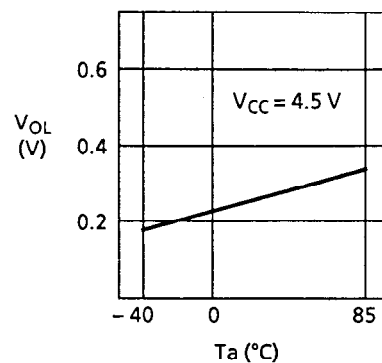

SERIAL NON-VOLATILE RAM
S-24 Series

2. AC Characteristics

2.1 SK pulse width t_{SK} —
 Ambient temperature T_a

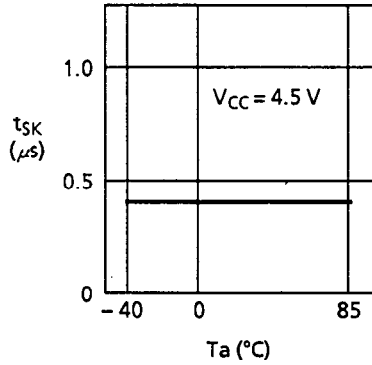

2.2 SK pulse width t_{SK} —
 Power supply voltage V_{CC}

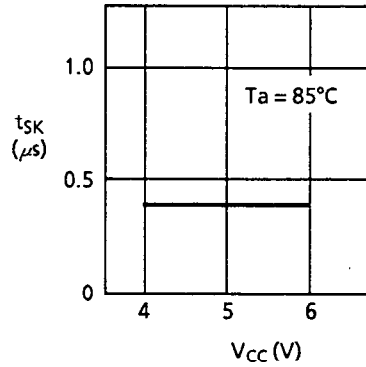

2.3 Input data setup time t_{DS} —
 Ambient temperature T_a

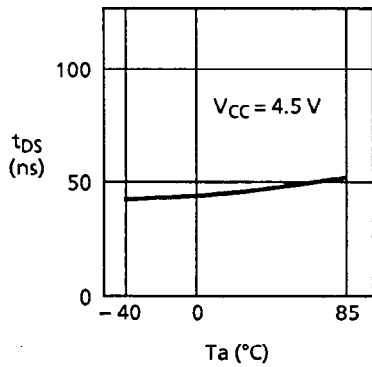

2.4 Input data hold time t_{DH} —
 Ambient temperature T_a

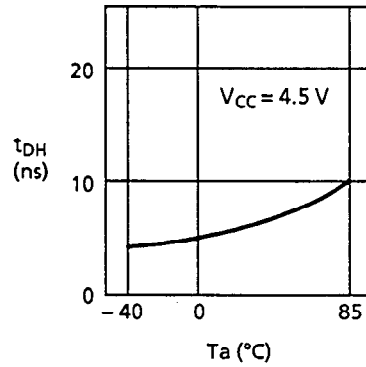

2.5 SK data valid time t_{PD} —
 Ambient temperature T_a

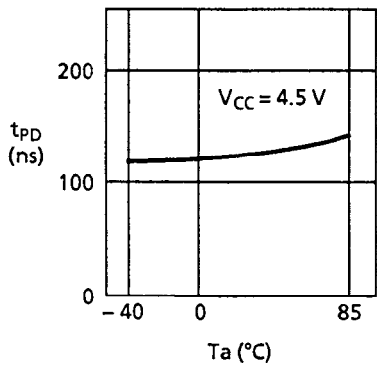

2.6 Recall pulse width t_{RCP} —
 Ambient temperature T_a

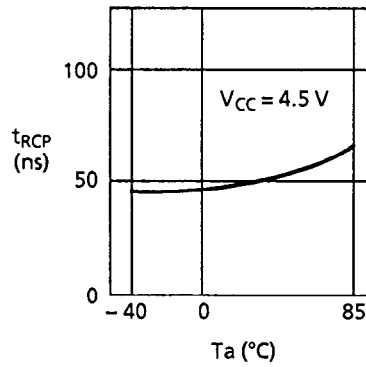

2.7 Recall cycle time t_{RCC} —
 Ambient temperature T_a

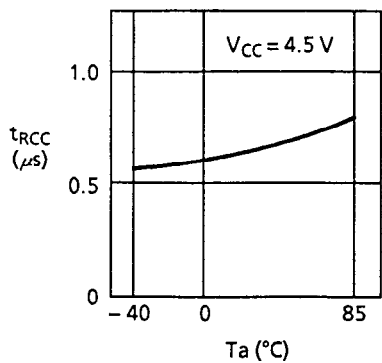

2.8 Store time t_{ST} —
 Ambient temperature T_a

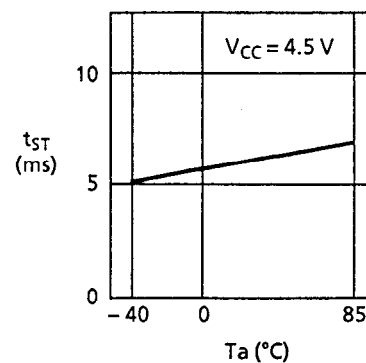

3. Rewriting Characteristics

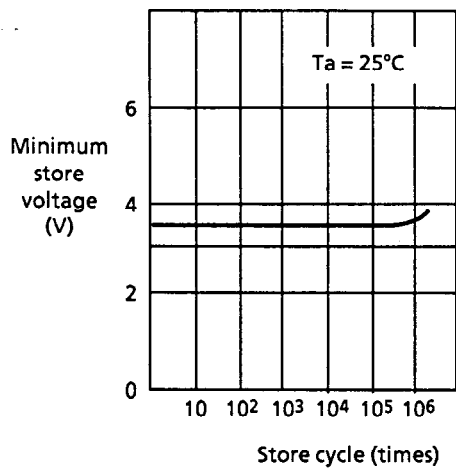

- The information herein is subject to change without notice.
- Seiko Instruments Inc. is not responsible for any problems caused by circuits or other diagrams described herein whose industrial properties, patents or other rights belong to third parties. The application circuit examples explain typical applications of the products, and do not guarantee any mass-production design.
- When the products described herein include Strategic Products (or service) subject to COCOM regulations, they should not be exported without authorization from the appropriate governmental authorities.
- The products described herein cannot be used as part of any device or equipment which influences the human body, such as physical exercise equipment or medical equipment, without prior written permission of Seiko Instruments Inc.