

Contents

Features	1
Block Diagram	1
Pin Arrangement	1
Dimensions	2
Absolute Maximum Ratings	2
Electrical Characteristics	2
Definition of Terms	3
Application Temperature Switch	4
Characteristics	5

The S-8100BF is a high-precision temperature compensation IC, integrated on a single chip with a linear output voltage of -8.1mV/K . It is composed of a temperature sensor, a constant current circuit, and an operational amplifier. Its temperature range is from -40°C to $+100^\circ\text{C}$. The S-8100BF has much better linearity than other temperature sensors such as thermistors. It can be used for a wide application range of temperature controls.

■ Features

- Linear output voltage : $-8.1\text{mV/K} (-8.1\text{mV}/^\circ\text{C})$
 $T_a = -20^\circ\text{C} : 1.900\text{V}$
 $T_a = +30^\circ\text{C} : 1.497\text{V}$
 $T_a = +80^\circ\text{C} : 1.085\text{V}$
- Linearity : $\pm 1.0\%$ (-20°C to $+80^\circ\text{C}$)
- Repeatability : $\pm 0.3\%$
- V_{SS} standard output
- Built-in operational amplifier
- Current consumption : $10\mu\text{A}$ (25°C) typ.
- Compact 3-pin plastic package

■ Block Diagram

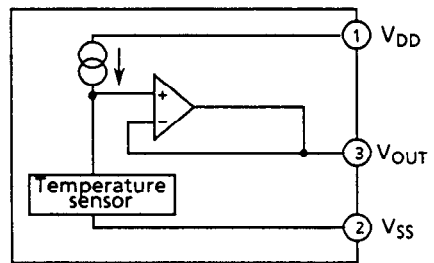

Figure 1

■ Pin Arrangement

SOT-89-3

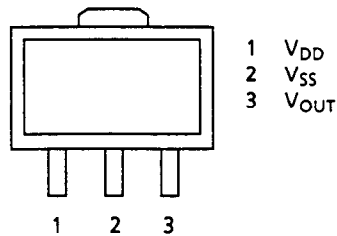
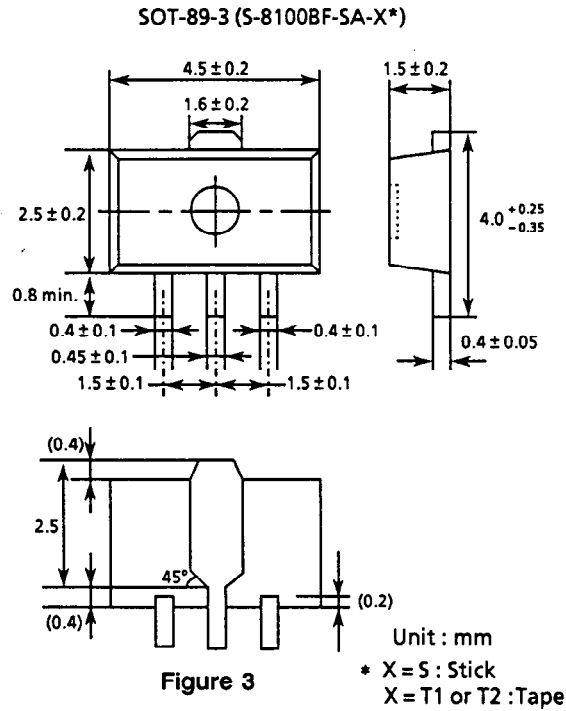

Figure 2

CMOS TEMPERATURE COMPENSATION IC S-8100BF

■ Dimensions



■ Absolute Maximum Ratings

Table 1

Parameter	Symbol	Ratings	Unit
Power supply voltage ($V_{SS} = 0V$)	V_{DD}	6	V
Input/output voltage	V_{IN} , V_{OUT}	V_{SS} to V_{DD}	V
Operating temperature	T_{opr}	-40 to +100	°C
Storage temperature	T_{stg}	-55 to +125	°C

■ Electrical Characteristics

Table 2

($-40^{\circ}C \leq T_a \leq +100^{\circ}C$, $V_{DD} = 5.0V$)

Parameter	Symbol	Conditions	Min.	Typ.	Max.	Unit
Power supply voltage	V_{DD}		3.0	5.0	5.5	V
Temperature sensitivity	V_{SE}	$-20^{\circ}C \leq T_a \leq +80^{\circ}C$	—	-8.14	—	mV/°C
Output voltage	V_{OUT}	$T_a = -20^{\circ}C$	1.852	1.900	1.964	V
		$T_a = +30^{\circ}C$	1.452	1.497	1.564	V
		$T_a = +80^{\circ}C$	1.039	1.085	1.151	V
Linearity	ΔNL	$-20^{\circ}C$ to $+80^{\circ}C$	—	—	± 1.0	%
Reproducibility	ΔV_{OUT}		—	—	± 0.3	%
Operating temperature	T_{opr}	$\Delta NL \leq \pm 2.0\%$	-40	—	100	°C
Current consumption	I_{DD}	$T_a = +25^{\circ}C$	—	10	20	μA
Output resistance	R_o	$T_a = +25^{\circ}C$	—	50	—	k Ω

■ Definition of Terms

1. Deviation of V_{OUT}

Maximum output voltage difference at -20°C , 30°C , and 80°C

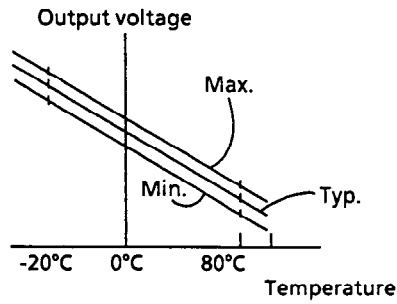

2. Linearity (ΔNL)

$$\Delta\text{NL} = \frac{a}{b}$$

a : Maximum output voltage difference between (A) and (B)

b : Output voltage

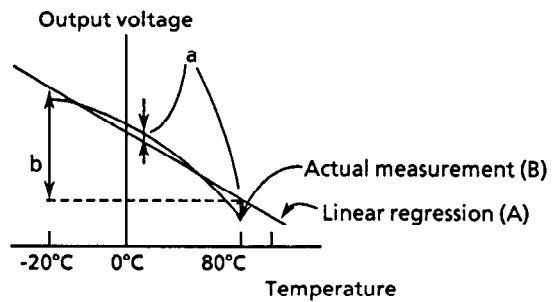

3. Reproducibility (ΔV_{OUT})

$$\Delta V_{OUT} = \frac{c}{b}$$

Maximum output voltage difference between before and after long-term reliability tests (1000H, high temperature and high humidity, etc.)

(Long-term reliability test at high temperature and under high humidity)

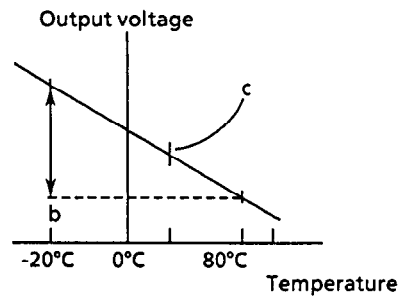

4. Output resistance (R_O)

$$R_O = \frac{\Delta V_O}{\Delta I_O}$$

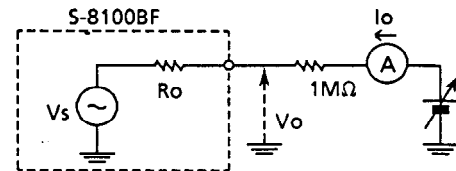

■ Application Temperature Switch

- Block Diagram

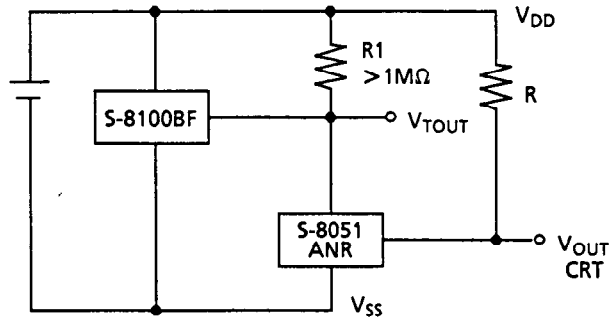
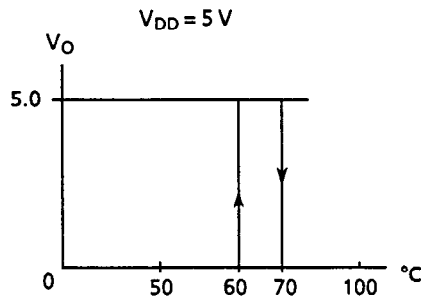

Figure 4

- Any desired temperature can be detected by combining the S-8100BF with a Seiko Instruments voltage detector and operating within the temperature range of the voltage detector.

- Output waveform



For the S-8051ANR, this becomes the 70°C temperature switch.

Figure 5

Note: Because the output impedance of the S-8100BF's CMOS output buffer is high, the output voltage level may fall because of contact with external circuits. If this happens, apply pull-up resistance, as shown in Figure 6.

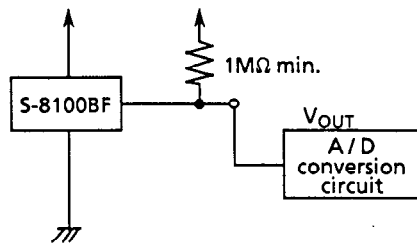
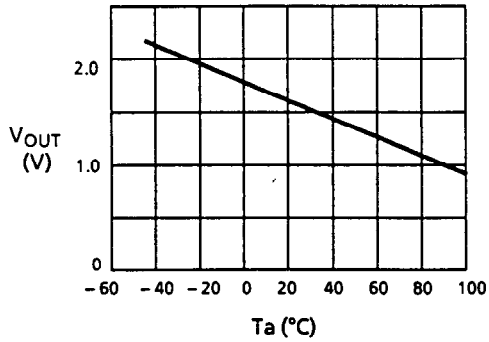

Figure 6

■ Characteristics

1. Ambient temperature (T_a)
- Output voltage (V_{OUT})



2. Ambient temperature (T_a)
- Current consumption (I_{DD})

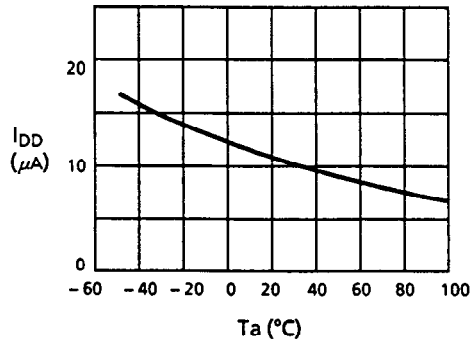

3. Power supply voltage (V_{DD})
- Output voltage (V_{OUT})

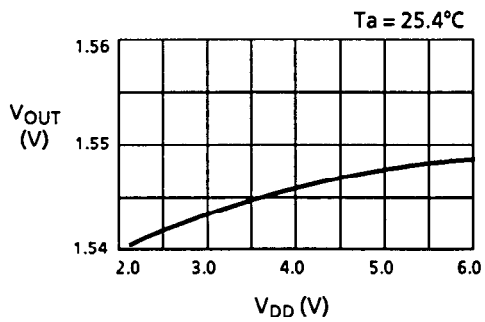

4. Power supply voltage (V_{DD})
- Current consumption (I_{DD})

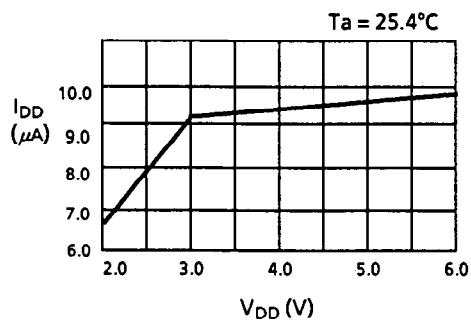

5. Heat response

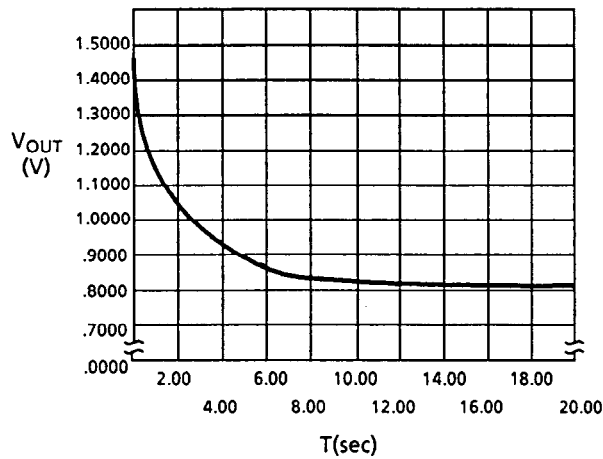

25°C → 100°C

$T_1 = 8$ sec

$T_2 = 2$ sec

T_1 : Time required for output voltage to reach 95% of attainable voltage when a package is put into 100°C of water from 25°C of air.

T_2 : Time required for output voltage to reach 65% of attainable voltage when a package is put into 100°C of water from 25°C of air.