

Electroluminescent Lamp Driver Low Voltage Applications

- Low Voltage, Single Battery Operation
($V_{\text{BATTERY}} \geq 1.1 \text{ VDC}$)
- DC to AC Inverter for EL Backlit
Display Panels
- Externally Adjustable Internal Oscillator
- Low Current Standby Mode

APPLICATIONS

- Pagers
- Digital Watches
- Backlit LCD Displays

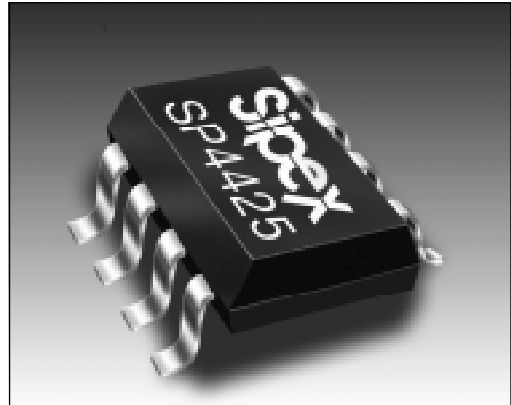

DESCRIPTION

The **SP4425** is a high voltage output DC-AC converter that can operate from a single 1.5 VDC power supply. The **SP4425** is capable of supplying up to 220 V_{pp} signals, making it ideal for driving electroluminescent lamps. The device features 1 μA (typical) standby current for use in low power portable products. One external inductor is required to generate the high voltage charge and one external capacitor is used to select the oscillator and lamp frequencies. The **SP4425** is offered in both an 8-pin narrow SOIC and 8-pin micro SOIC package. For delivery in die form, please consult the factory.

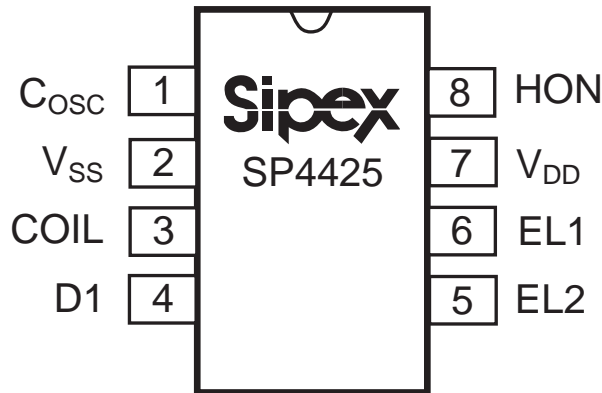

SP4425 Block Diagram

ABSOLUTE MAXIMUM RATINGS

These are stress ratings only and functional operation of the device at these ratings or any other above those indicated in the operation sections of the specifications below is not implied. Exposure to absolute maximum rating conditions for extended periods of time may affect reliability.

V_{DD}	5V
Input Voltages/Currents	
HON (pin1).....	-0.5V to ($V_{DD} + 0.5V$)
COIL (pin3).....	100mA
Lamp Outputs.....	230V _{PP}
Storage Temperature.....	-65°C to +150°C
Power Dissipation Per Package	
8-pin NSOIC (derate 6.14mW/°C above +70°C).....	500mW
8-pin μ SOIC (derate 4.85mW/°C above +70°C).....	390mW

The information furnished herein by Sipex has been carefully reviewed for accuracy and reliability. Its application or use, however, is solely the responsibility of the user. No responsibility for the use of this information is assumed by Sipex, and this information shall not explicitly or implicitly become part of the terms and conditions of any subsequent sales agreement with Sipex. Specifications are subject to change without prior notice. By the sale or transfer of this information, Sipex assumes no responsibility for any infringement of patents or other rights of third parties which may result from its use. No license or other proprietary rights are granted by implication or otherwise under any patent or patent rights of Sipex Corporation.

SPECIFICATIONS

($T = 25^\circ\text{C}$; $V_{DD} = 1.5\text{V}$; Lamp Capacitance = 8200pF with 1 00 Ω Series resistance; Coil = 470 μH at 4 Ohms; $C_{OSC} = 180\text{pF}$ unless otherwise noted); $C_{INT} = 1800\text{pF}$

PARAMETER	MIN.	TYP.	MAX.	UNITS	CONDITIONS
Supply Voltage, V_{DD}	1.1	1.5	1.7	V	
Supply Current, $I_{COIL} + I_{DD}$		30	60	mA	$V_{HON} = V_{DD} = 1.5\text{V}$
Coil Voltage, V_{COIL}	V_{DD}		1.7	V	
HON Input Voltage, V_{HON} LOW: EL off HIGH: EL on	-0.25 $V_{DD} - 0.25$	0 V_{DD}	0.25V $V_{DD} + 0.25$	V	
HON Current, EL on		3	15	μA	internal pulldown, $V_{HON} = V_{DD} = 1.5\text{V}$
Shutdown Current, $I_{SD} = I_{COIL} + I_{DD}$		1	5	μA	$V_{HON} = 0\text{V}$
INDUCTOR DRIVE					
Coil Frequency, $f_{COIL} = f_{LAMP} \times 64$		25.6		kHz	
Coil Duty Cycle		90		%	
Peak Coil Current, $I_{PK-COIL}$			90	mA	Guaranteed by design.
EL LAMP OUTPUT					
EL Lamp Frequency, f_{LAMP}	300	400	500	Hz	$T_{AMB} = +25^\circ\text{C}$, $V_{DD} = 1.5\text{V}$ $T_{AMB} = -40^\circ\text{C}$ to $+85^\circ\text{C}$, $V_{DD} = 1.5\text{V}$
Peak to Peak Output Voltage	120 90	160		V_{PP}	$T_{AMB} = +25^\circ\text{C}$, $V_{DD} = 1.5\text{V}$ $T_{AMB} = -40^\circ\text{C}$ to $+85^\circ\text{C}$, $V_{DD} = 1.5\text{V}$

(T= 25°C; V_{DD} = 3.0V; Lamp Capacitance = 4nF with 100Ω Series resistance; Coil = 2mH/44ohms; C_{OSC} = 180pF, C_{INT} = 470pF unless otherwise noted)

PARAMETER	MIN.	TYP.	MAX.	UNITS	CONDITIONS
Supply Voltage, V _{DD}	2.2	3.0	3.3	V	
Supply Current, I _{COIL} +I _{DD}		28	35	mA	V _{HON} =V _{DD} =3V
Coil Voltage, V _{COIL}	V _{DD}		3.3	V	
HON Input Voltage, V _{HON} LOW: EL off HIGH: EL on	-0.25 V _{DD} -0.25	0 V _{DD}	0.25V V _{DD} +0.25	V	
HON Current, EL on		5	20	μA	internal pulldown, V _{HON} =V _{DD} =3V
Shutdown Current, I _{SD} =I _{COIL} +I _{DD}		1	8	μA	V _{HON} =0V
INDUCTOR DRIVE					
Coil Frequency, f _{COIL} =f _{LAMP} x64		28.8		kHz	
Coil Duty Cycle		90		%	
Peak Coil Current, I _{PK-COIL}			90	mA	Guaranteed by design.
EL LAMP OUTPUT					
EL Lamp Frequency, f _{LAMP}	350 275	450	550 775	Hz	T _{AMB} =+25°C, V _{DD} =3.0V T _{AMB} =-40°C to +85°C, V _{DD} =3.0V
Peak to Peak Output Voltage	120 170 120	150 190		V _{PP}	T _{AMB} =+25°C, V _{DD} =2.2V T _{AMB} =+25°C, V _{DD} =3.0V T _{AMB} =-40°C to +85°C, V _{DD} =3.0V

This data sheet specifies environmental parameters, final test conditions and limits as well suggested operating conditions. For applications which require performance beyond the specified condition and or limits please consult the factory.

Bonding Diagram:

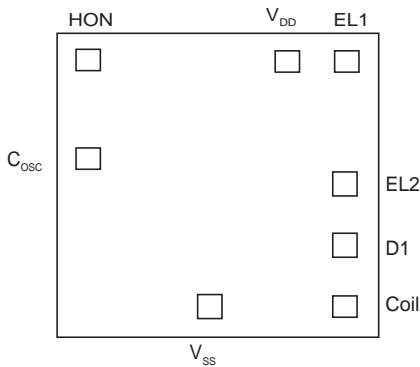

PAD	X	Y
V _{DD}	261.0	427.0
EL1	813.0	429.0
EL2	813.0	28.0
D1	813.0	-172.0
COIL	767.0	-381.0
V _{SS}	143.5	-412.0
C _{OSC}	-790.0	-157.5
HON	-785.5	402.0

NOTES:

1. Dimensions are in Microns unless otherwise noted.
2. Bonding pads are 125x125 typical.
3. Outside dimensions are maximum, including scribe area.
4. Die thickness is 10 mils +/- 1.
5. Pad center coordinates are relative to die center.
6. Die size 74 x 44 mils.

PIN DESCRIPTION

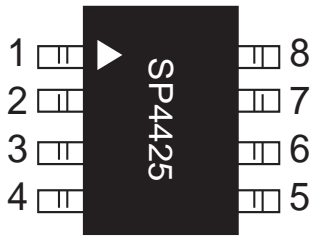

Pin 1 – C_{OSC} - Capacitor input 1, connect Capacitor from V_{SS} to Pin 1 to set C_{OSC} frequency.

Pin 2 – V_{SS} - Power supply common, connect to ground.

Pin 3 – Coil- Coil input, connect coil from V_{DD} to pin 3.

Pin 4 – D1- Diode Cathode connection.

– C_{INT} - Integrator capacitor, connect capacitor from pin 4 to ground to minimize coil glitch energy.

Pin 5 – Lamp- Lamp driver output2, connect to EL lamp.

Pin 6 – Lamp- Lamp driver output1, connect to EL lamp.

Pin 7 – V_{DD} - Power supply for driver, connect to system V_{DD} .

Pin 8 – HON- Enable for driver operation, high = active; low = inactive.

THEORY OF OPERATION

The **SP4425** is made up of three basic circuit elements, an oscillator, coil, and switched H-bridge network. The oscillator provides the device with an on-chip clock source used to control the charge and discharge phases for the coil and lamp. An external capacitor connected between pins 1 and V_{SS} allows the user to vary the oscillator frequency. For a given choice of coil inductance there will be an optimum C_{OSC} Capacitor value that gives the maximum light output.

The suggested oscillator frequency is 25.6kHz ($C_{OSC}=180\text{pF}$). The oscillator output is internally divided to create the control signal for f_{LAMP} . The oscillator output is internally divided down by 6 flip flops, a 25.6kHz signal will be divided into 6 frequency levels: 12.8kHz, 6.4kHz, 3.2kHz, 1.6kHz, 800Hz, and 400Hz. The oscillator output (25.6kHz) is used to drive the coil (see **figure 2** on **page 11**) and the sixth flip flop output (300Hz) is used to drive the lamp. Although the oscillator frequency can be varied to optimize the lamp output, the ratio of f_{COIL}/f_{LAMP} will always equal 64.

The coil is an external component connected from $V_{BATTERY}$ to pin 3 of the **SP4425**. $V_{BATTERY}=1.5\text{VDC}$ with a $470\mu\text{H}/4\Omega$ coil are typical conditions. Energy is stored in the coil according to the equation $E_L=1/2LI^2$, where I is the peak current flowing in

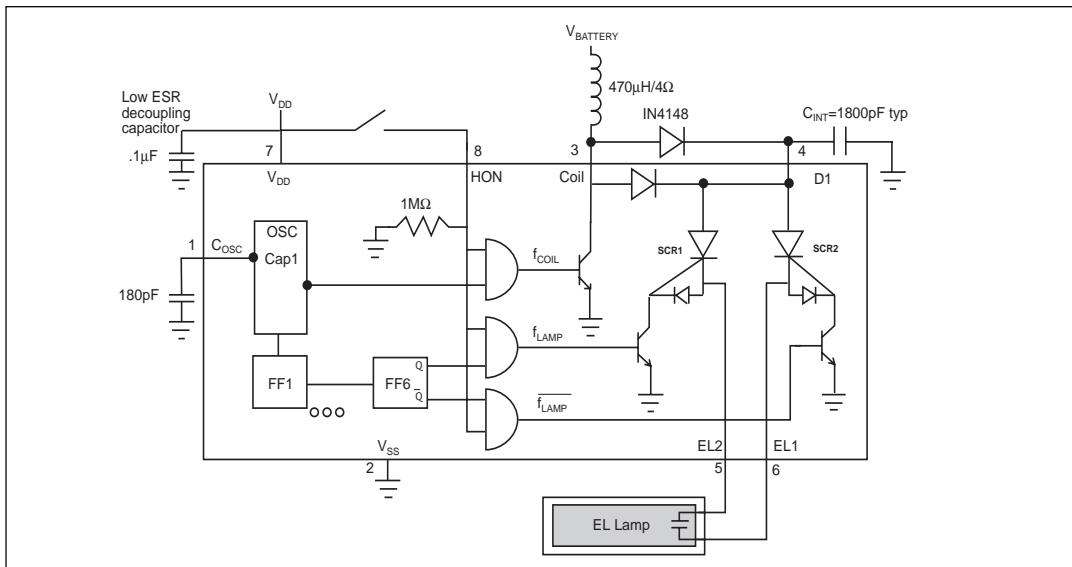

SP4425 Schematic

the inductor. The current in the inductor is time dependent and is set by the "ON" time of the coil switch: $I=(V_L/L)t_{ON}$, where V_L is the voltage across the inductor. At the moment the switch closes, the current in the inductor is zero and the entire supply voltage (minus the V_{SAT} of the switch) is across the inductor. The current in the inductor will then ramp up at a linear rate. As the current in the inductor builds up, the voltage across the inductor will decrease due to the resistance of the coil and the "ON" resistance of the switch: $V_L=V_{BATTERY}-IR_L-V_{SAT}$. Since the voltage across the inductor is decreasing, the current ramp-rate also decreases which reduces the current in the coil at the end of t_{ON} the energy stored in the inductor per coil cycle and therefore the light output. The other important issue is that maximum current (saturation current) in the coil is set by the design and manufacturer of the coil. If the parameters of the application such as $V_{BATTERY}$, L , R_L or t_{ON} cause the current in the coil to increase beyond its rated I_{SAT} , excessive heat will be generated and the power efficiency will decrease with no additional light output.

The majority of the current goes through the coil and typically less than 2mA is required for V_{DD} of the **SP4425**. V_{DD} can range from 1.5V to 3.0V; it is not necessary that $V_{DD}=V_{BATTERY}$. Coils are also a function of the core material and winding used -- performance variances may be noticeable from different coil suppliers. The Sipex **SP4425** is final tested at 1.5V using a 470 μ H/4 Ω coil from Toko, and a 2mH/44 Ω coil from Matsushita at 3V. For suggested coil sources see *page 12*.

The f_{COIL} signal controls a switch that connects the end of the coil at pin 3 to ground or to open circuit. The f_{COIL} signal is a 90% duty cycle signal switching at the oscillator frequency. During the time when the f_{COIL} signal is high, the coil is connected from $V_{BATTERY}$ to ground and a charged magnetic field is created in the coil. During the low part of f_{COIL} , the ground connection is switched open, the field collapses and the energy in the inductor is forced to flow toward the lamp. f_{COIL} will send 32 of these charge pulses (see *figure 2 on page 11*) lamp, each pulse increases the voltage drop across the lamp in discrete steps. As the voltage potential approaches its maximum, the steps become smaller (see *figure 1 on page 11*).

The H-bridge consists of two SCR structures that act as high voltage switches. These two switches control the polarity of how the lamp is charged. The SCR switches are controlled by the f_{LAMP} signal which is the oscillator frequency divided by 64. For a 25.6kHz oscillator, $f_{LAMP}=400$ Hz.

When the energy from the coil is released, a high voltage spike is created triggering the SCR switches. The direction of current flow is determined by which SCR is enabled. One full cycle of the H-bridge will create a voltage step from ground to 80V (typical) on pins 5 and 6 which are 180 degrees out of phase with each other (see *figure 3 on page 11*). A differential view of the outputs is shown in *figure 4 on page 11*.

Layout Considerations

The **SP4425** circuit board layout must observe careful analog precautions. For applications with noisy power supply voltages, a 0.1 μ F low ESR decoupling capacitor must be connected from Vdd to ground. Any high voltage traces should be isolated from any digital clock traces or enable lines. A solid ground plane connection is strongly recommended. All traces to the coil or to the high voltage outputs should be kept as short as possible to minimize capacitive coupling to digital clock lines and to reduce EMI emissions.

Integrator Capacitor

An integrating capacitor must be placed from pin 4 (D1) to ground in order to minimize glitches associated with switching the coil. A capacitor at this point will collect the high voltage spikes and will maximize the peak to peak voltage output. High resistance EL lamps will produce more pronounced spiking on the EL output waveform; adding the C_{INT} capacitor will minimize the peaking and increase the voltage output at each coil step. The value of the integrator capacitor is application specific typical values can range from 500pF to 0.1 μ F. No integrator capacitor or very small values (500pF) will have a minor effect on the output, whereas a 0.1 μ F capacitor will cause the output to charge and discharge rapidly creating a square wave output. For most applications an 1800pF integrator capacitor is suitable.

Electroluminescent Technology

What is electroluminescence?

An EL lamp is basically a strip of plastic that is coated with a phosphorous material which emits light (fluoresces) when a high voltage (>40V) which was first applied across it, is removed or reversed. Long periods of DC voltages applied to the material tend to breakdown the material and reduce its lifetime. With these considerations in mind, the ideal signal to drive an EL lamp is a high voltage sine wave. Traditional approaches to achieving this type of waveform included discrete circuits incorporating a transformer, transistors, and several resistors and capacitors. This approach is large and bulky, and cannot be implemented in most hand held equipment. **Sipex** now offers low power single chip driver circuits specifically designed to drive small to medium sized electroluminescent panels if all that is required is one external inductor fast recovery diode and two capacitors.

Electroluminescent backlighting is ideal when used with LCD displays, keypads, or other backlit readouts. Its main use is to illuminate displays in dim to dark conditions for momentary periods of time. EL lamps typically consume less than LEDs or bulbs making them ideal for battery powered products. Also, EL lamps are able to evenly light an area without creating "hot spots" in the display.

The amount of light emitted is a function of the voltage applied to the lamp, the frequency at which it is applied, the lamp material used and its size, and lastly, the inductor used. Both voltage and frequency are directly related to light output. In other words as the voltage or the frequency of the EL output is increased the light output will also increase. The voltage has a much larger impact on light output than the frequency does. For example, an output signal of 168V_{pp} with a frequency of 500Hz can yield 15Cd/m², in the same application a different EL driver could produce 170V_{pp} with a frequency of 450Hz and can also yield 15Cd/m². Variations in peak to peak voltage and variations in lamp frequency are to be expected, light output will also vary from device to device however typical light output variations are usually not visually noticeable.

There are many variables which can be optimized for specific applications. **Sipex** supplies characterization charts to aid the designer in selecting the optimum circuit configuration (see *page 7* and *8*).

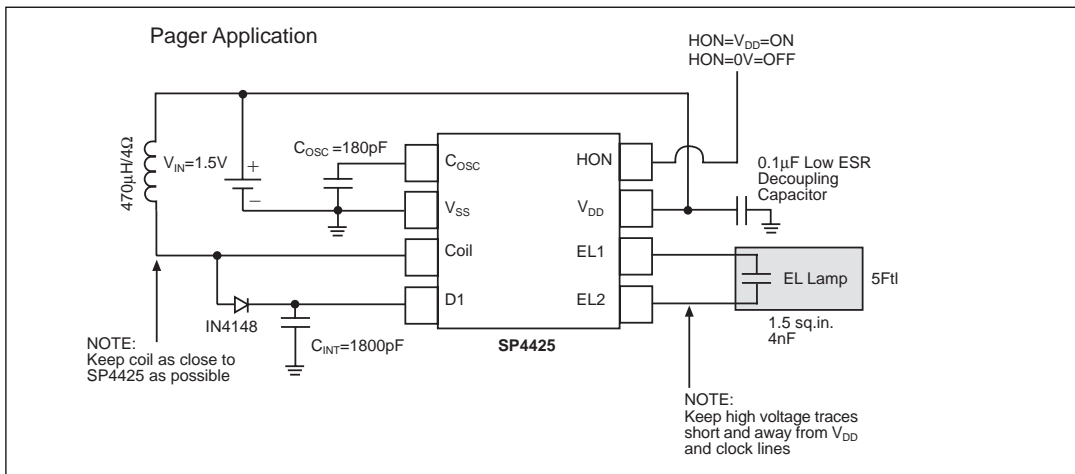

Typical SP4425 Application Circuit

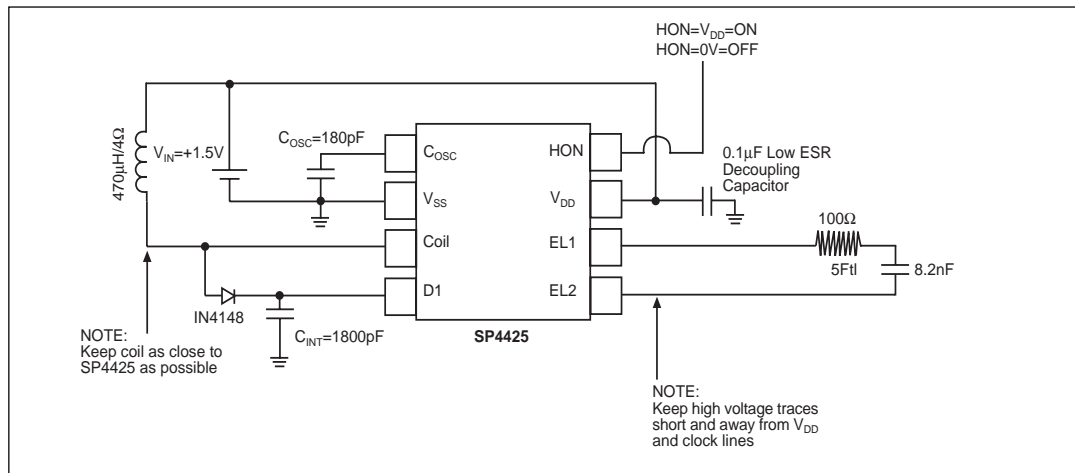

SP4425 1.5V Test Circuit

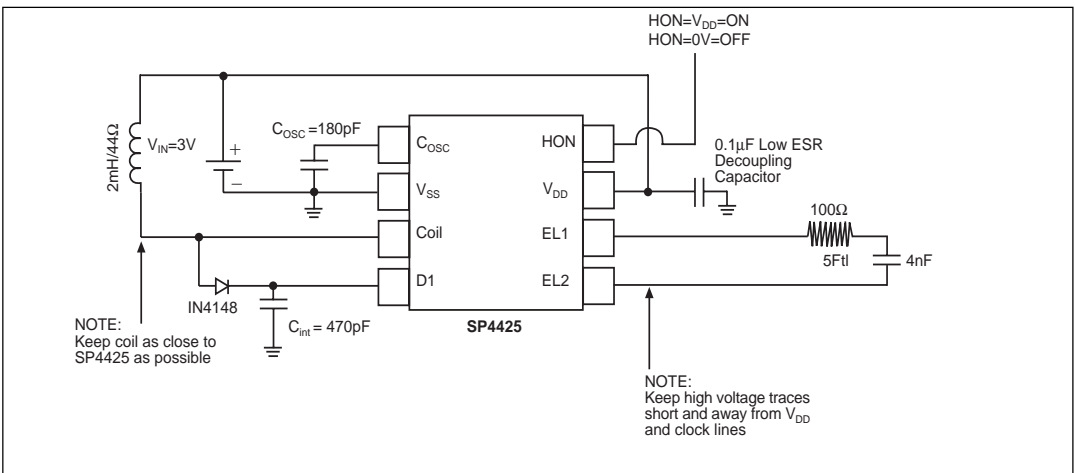

SP4425 3V Test Circuit

The following performance curves are intended to give the designer a relative scale from which to optimize specific applications. Absolute measurements may vary depending upon the brand of components chosen.

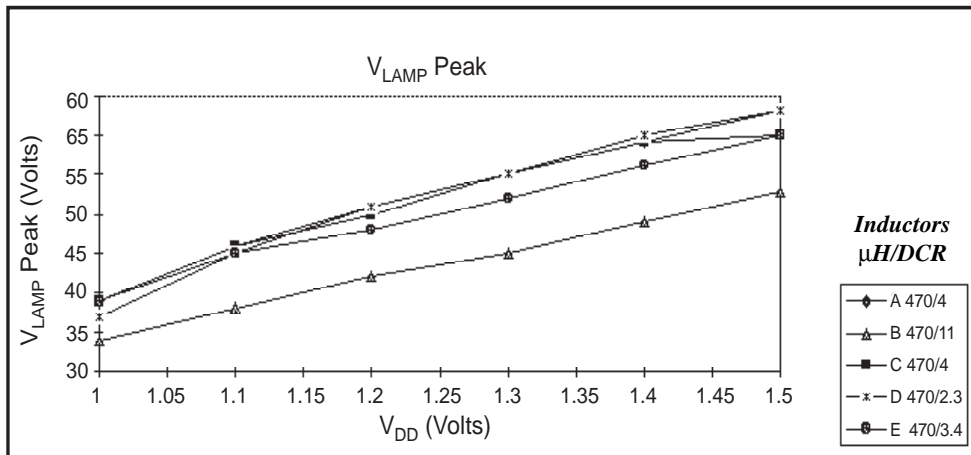

Lamp = 1.5 sq. in., C1 = 0.1 μ F, C2 = 180pF, D1 = DIN4148

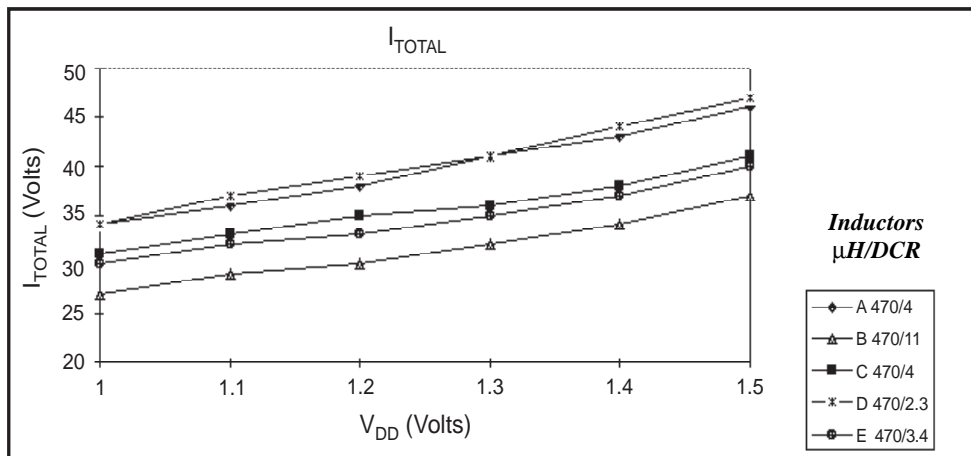

Lamp = 1.5 sq. in., C1 = 0.1 μ F, C2 = 180pF, D1 = DIN4148

The following performance curves are intended to give the designer a relative scale from which to optimize specific applications. Absolute measurements may vary depending upon the brand of components chosen.

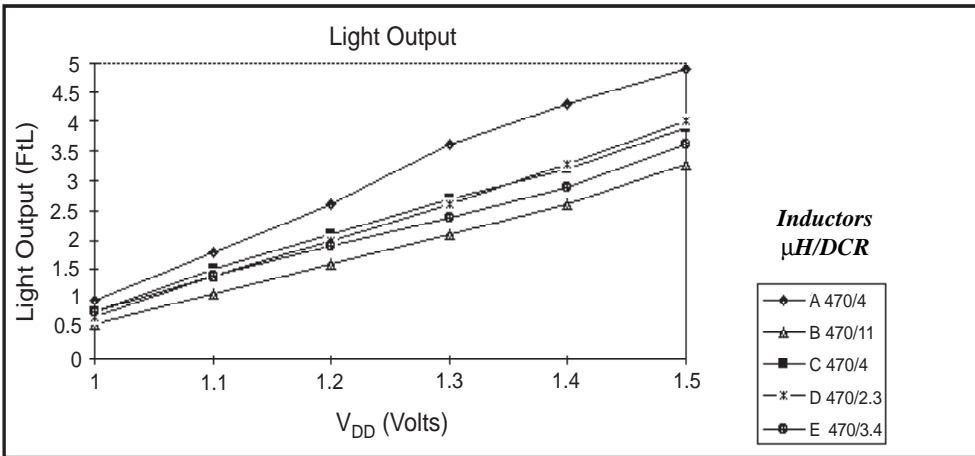

Lamp = 1.5 sq. in., $C1 = 0.1\mu F$, $C2 = 180pF$, $D1 = DIN4148$

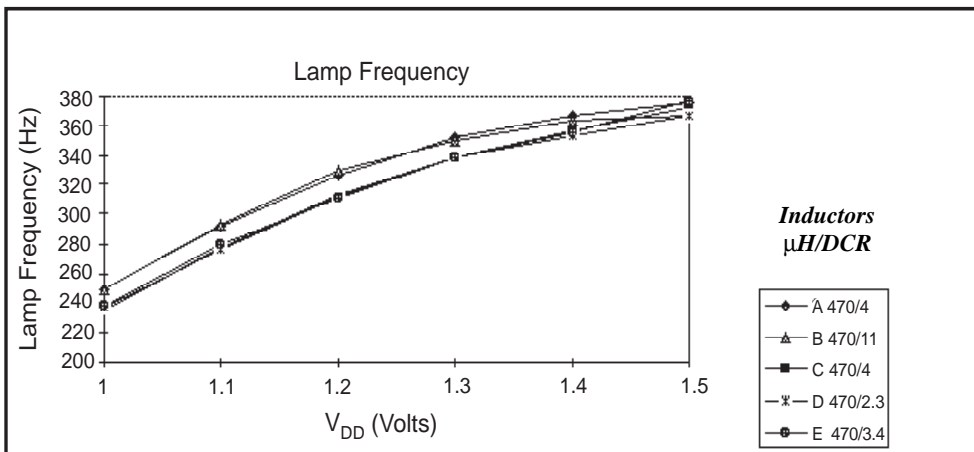

Lamp = 1.5 sq. in., $C1 = 0.1\mu F$, $C2 = 180pF$, $D1 = DIN4148$

The following performance curves are intended to give the designer a relative scale from which to optimize specific applications. Absolute measurements may vary depending upon the brand of components chosen.

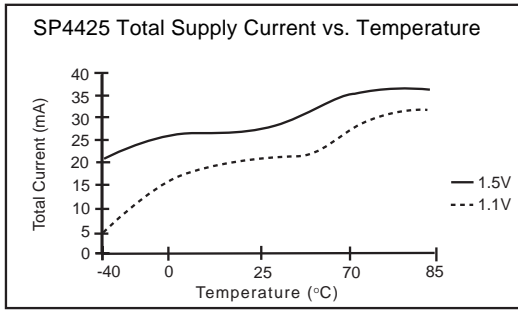

Coil=470μH/4Ω; C_{OSC}=180pF;
C_{INT}=1800pF; C_{LOAD}=4.7nF

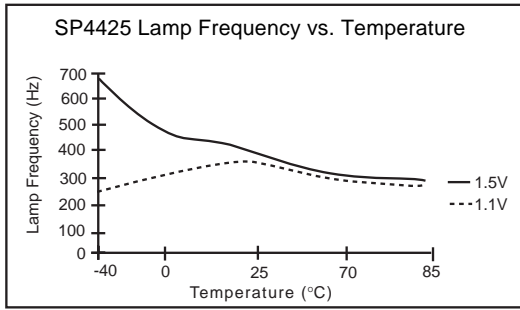

Coil=470μH/4Ω; C_{OSC}=180pF;
C_{INT}=1800pF; C_{LOAD}=4.7nF

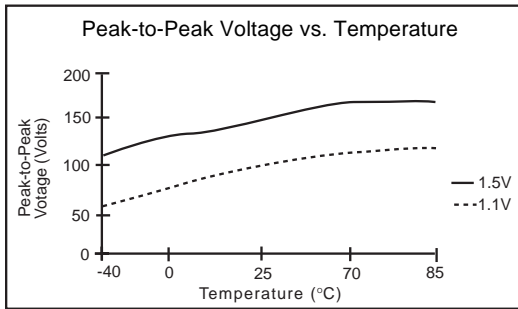

Coil=470μH/4Ω; C_{OSC}=180pF;
C_{INT}=1800pF; C_{LOAD}=4.7nF

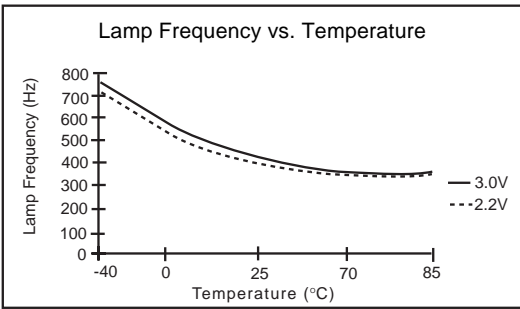

Coil=2mH/44Ω; C_{OSC}=180pF;
C_{INT}=470pF; C_{LOAD}=4nF

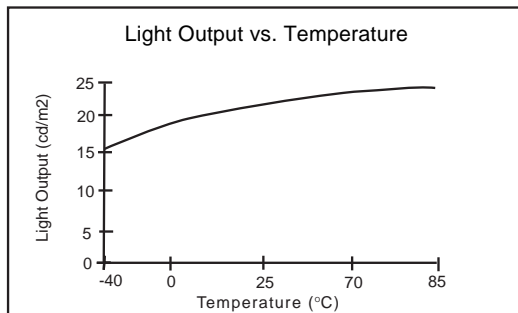

Coil=2mH/44Ω; C_{OSC}=180pF;
C_{INT}=470pF; V_{DD}=3.0V; Load=3 sq.in.

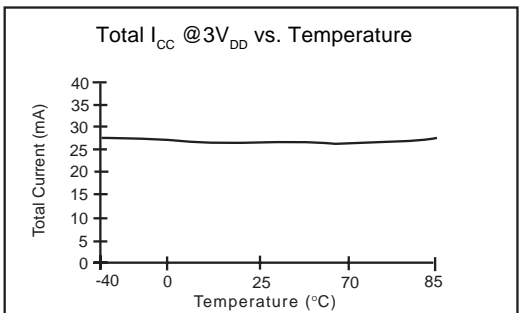

Coil=2mH/44Ω; C_{OSC}=180pF;
C_{INT}=470pF; C_{LOAD}=4nF

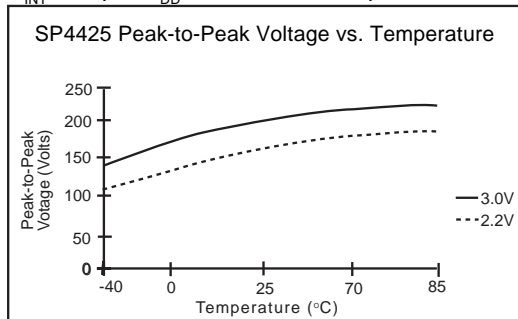

Coil=2mH/44Ω; C_{OSC}=180pF;
C_{INT}=470pF; C_{LOAD}=4nF

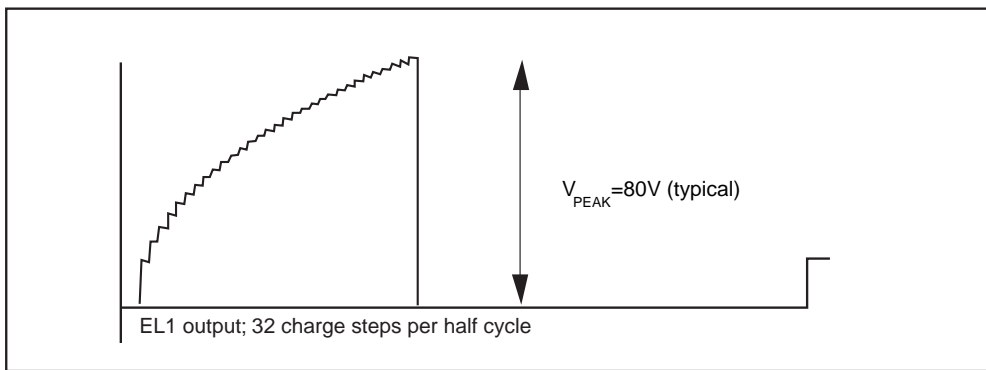

Figure 1. EL output voltage in discrete steps at EL1 output

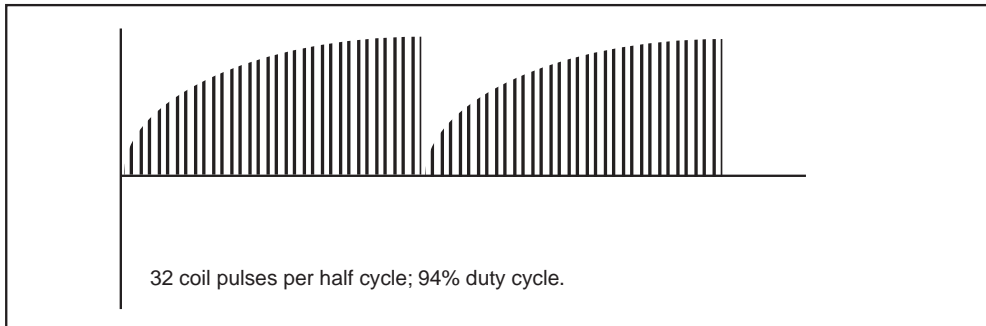

Figure 2. Voltage pulses released from the coil to the EL driver circuitry

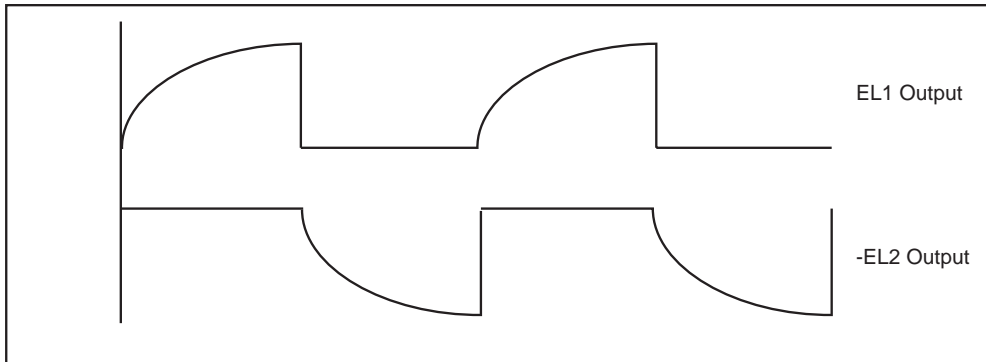

Figure 3. EL voltage waveforms from the EL1 and EL2 outputs

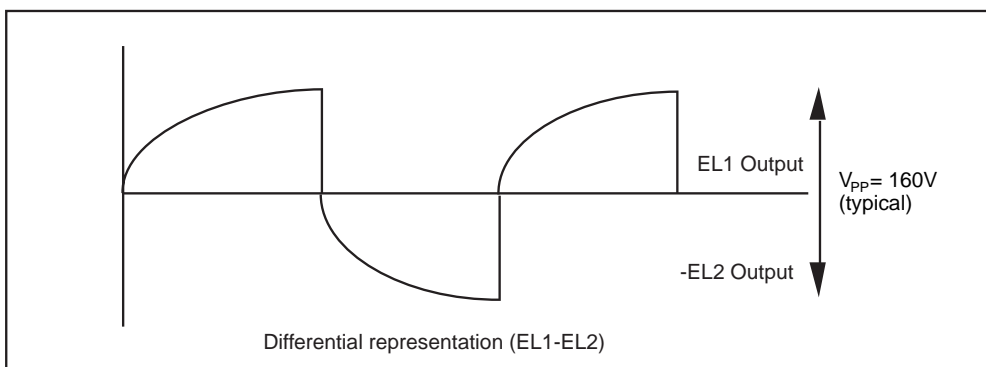

Figure 4. El differential output waveform of the EL1 and EL2 outputs

The coil part numbers presented in this data sheet have been qualified as being suitable for the SP4425 product. Contact Sipex for applications assistance in choosing coil values not listed in this data sheet.

Coil Manufacturers

Coilcraft USA
Ph: (847) 639-6400
Fax: (847) 639-1469

Coilcraft Taiwan
Ph: 886/2/264-3646
Fax: 886/2/270-0294

Coilcraft Hong Kong
Ph: 852 770-9428
Fax: 852 770-0729

Coilcraft Europe
Ph: 44 01236 730595
Fax: 44 01236 730627

Coil Craft Singapore
Ph: 65 296-6933
Fax: 465 296-4463 #382

Part No. DO1608C-474
470µH, 3.60 ohm

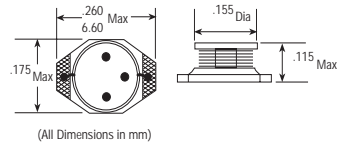

muRata USA
Ph: (770) 436-1300
Fax: (770) 436-3030

muRata Taiwan Electronics
Ph: 011 88642914151
Fax: 011 88644252929

muRata Hong Kong
Ph: 011-85223763898
Fax: 011 85223755655

muRata Europe
Ph: 011-4991166870
Fax: 011-49116687225

muRata Electronics Singapore
Ph: 011 657584233
Fax: 011 657536181

Part No. LQN4N471K04
470µH, 11.5 ohm

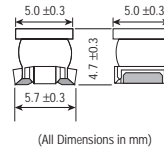

KOA Speer Electronics, Inc.
Ph: 814-362-5536
Fax: 814-362-8883

Part No. LPC4045TE471K
470µH, 4.55 ohm

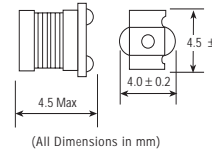

Sumida Electric Co., LTD. USA
Ph: (847) 956-0666
Fax: (847) 956-0702

Sumida Electric Co., LTD. Singapore
Ph: 2963388
Fax: 2963390

Sumida Electric Co., LTD. Japan
Ph: 03-3607-5111
Fax: 03-3607-5144

Sumida Electric Co., LTD. Hong Kong
Ph: 28806688
Fax: 25659600

Part No. CDRH74-471MC
470µH, 3.01 ohm

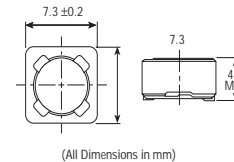

Toko America Inc. USA
Ph: (847) 297-0070
Fax: (847) 699-7864

Toko Inc. Japan
Ph: 03 3727 1161
Fax: 03 3727 1176

Toko Inc. Hong Kong
Ph: 2342-8131
Fax: 2341-9570

Toko Inc. Europe
Ph: (0211) 680090
Fax: (0211) 679-9567

Toko Inc. Singapore
Ph: (255) 4000
Fax: (250) 8134

Part No. 667MA471N
470µH, 1.90 ohm

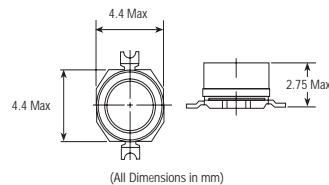

EL polarizers/translector manufacturers

Nitto Denko
San Jose, CA
Phone: (510) 445-5400

Astra Products
Baldwin, NJ
Phone: (516) 223-7500
Fax: (516) 868-2371

EL Lamp manufacturers

Metro Mark/Leading Edge
Minnetonka, MN
Phone: (800) 680-5556
Fax: (612) 935-5718

Midori Mark Ltd.
1-5 Komagata 2-Chome
Taita-Ku 111-0043 Japan
Phone: 81-03-3848-2011

Luminescent Systems Inc. (LSI)
4 Lucent Drive
Lebanon, NH 03766
Phone: (603) 643-7766
Fax: (603) 643-5947

NEC Corporation
Tokyo, Japan
Phone: (03) 3798-9572
Fax: (03) 3798-6134

Seiko Precision
Chiba, Japan
Phone: (03) 5610-7089
Fax: (03) 5610-7177

Gunze Electronics
2113 Wells Branch Parkway
Austin, TX 78728
Phone: (512) 752-1299
Fax: (512) 252-1181

All package dimensions in inches

8-pin NSOIC

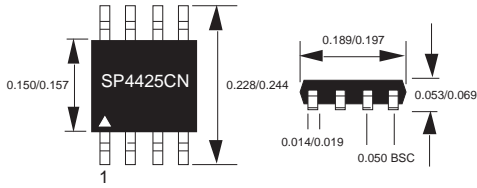

8-pin μ SOIC

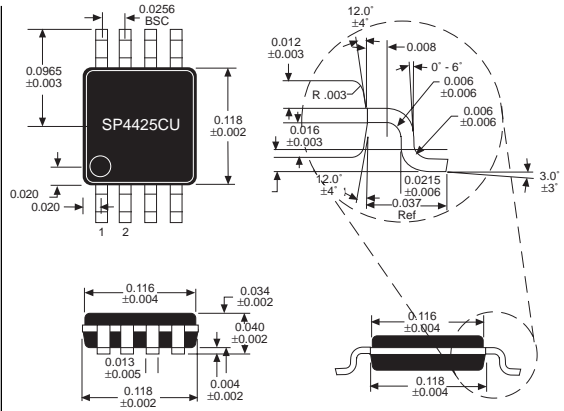

95 SP4425CN per tube, no minimum quantity



50 SP4425CU per tube

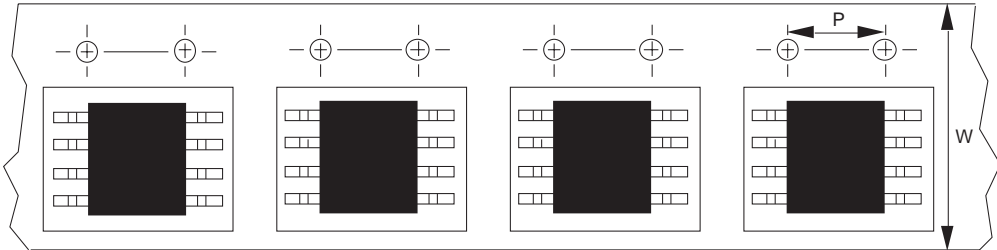

NSOIC-8 13" reels: P=8mm, W=12mm μ SOIC-8 13" reels: P=8mm, W=12mm			
Pkg.	Minimum qty per reel	Standard qty per reel	Maximum qty per reel
CN	500	2500	3000
CU	500	2500	3000

ORDERING INFORMATION

Model	Operating Temperature Range	Package Type
SP4425CN	-40°C to +85°C	8-Pin NSOIC
SP4425CU	-40°C to +85°C	8-Pin μ SOIC
SP4425CX	-40°C to +85°C	Die
SP4425NEB	N/A	NSOIC Evaluation Board
SP4425UEB	N/A	μ SOIC Evaluation Board

Please consult the factory for pricing and availability on a Tape-On-Reel option.



SIGNAL PROCESSING EXCELLENCE

Sipex Corporation

Headquarters and Sales Office

22 Linnell Circle
Billerica, MA 01821
TEL: (978) 667-8700
FAX: (978) 670-9001
e-mail: sales@sipex.com

Sales Office

233 South Hillview Drive
Milpitas, CA 95035
TEL: (408) 934-7500
FAX: (408) 935-7600

Sipex Corporation reserves the right to make changes to any products described herein. Sipex does not assume any liability arising out of the application or use of any product or circuit described hereing; neither does it convey any license under its patent rights nor the rights of others.