

Electroluminescent Lamp Driver

High Drive Capability for Low Voltage Applications

- Low Power +1.1V to +1.7V Single Cell Operation
- Low-Cost EL Driver Ideal for Backlighting
- DC-to-AC Inverter Generates High Voltage AC to Drive EL Lamps
- Externally Adjustable Oscillator
- Low Current Standby Mode

APPLICATIONS

- Pagers
- Watches
- Backlit LCD Displays

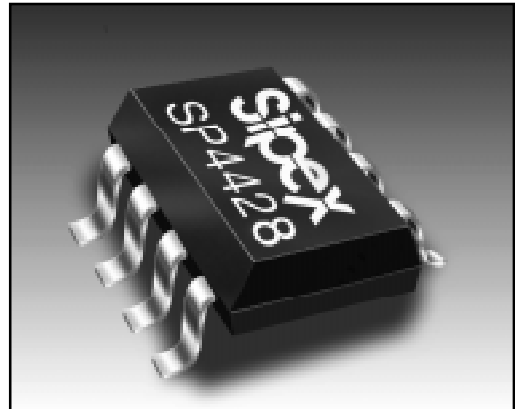

DESCRIPTION

The **SP4428** is a high voltage output DC-AC converter that can operate from a single 1.5 VDC power supply. The **SP4428** is capable of supplying 200 V_{pp} (typical), making it ideal for driving electroluminescent lamps. The device features 1μA (typical) standby current, for use in low power portable products. One external inductor is required to generate the high voltage charge, and one external capacitor is used to produce a clock signal that generates the coil and lamp frequencies. The **SP4428** is ideal for PDAs, pagers, and other low power portable applications using LCDs in dim or low light environments. The **SP4428** is offered in an 8-pin narrow SOIC. For delivery in die form, please consult the factory.

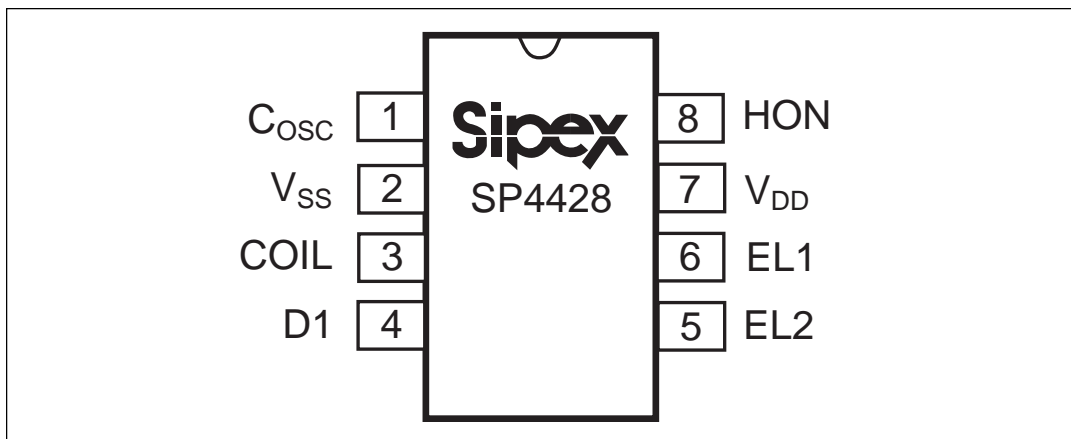

Block Diagram

ABSOLUTE MAXIMUM RATINGS

These are stress ratings only and functional operation of the device at these ratings or any other above those indicated in the operation sections of the specifications below is not implied. Exposure to absolute maximum rating conditions for extended periods of time may affect reliability.

TA= +25°C unless otherwise noted	
V _{DD}	5V
Input Voltages/Currents	
HON (pin1).....	-0.5V to (V _{DD} +0.5V)
COIL (pin3).....	100mA
Lamp Outputs.....	230V _{pp}
Storage Temperature.....	-65°C to +150°C
Power Dissipation Per Package	
8-pin NSOIC (derate 6.14mW/°C above +70°C).....	500mW

The information furnished herein by Sipex has been carefully reviewed for accuracy and reliability. Its application or use, however, is solely the responsibility of the user. No responsibility for the use of this information is assumed by Sipex, and this information shall not explicitly or implicitly become part of the terms and conditions of any subsequent sales agreement with Sipex. Specifications are subject to change without prior notice. By the sale or transfer of this information, Sipex assumes no responsibility for any infringement of patents or other rights of third parties which may result from its use. No license or other proprietary rights are granted by implication or otherwise under any patent or patent rights of Sipex Corporation.

SPECIFICATIONS

(T= 25°C; V_{DD} = 1.5V; Lamp Capacitance = 4.7nF; Coil = 470μH at 4.9 Ohms; C_{OSC} = 180pF unless otherwise noted) C_{INT} = 1800pF

PARAMETER	MIN.	TYP.	MAX.	UNITS	CONDITIONS
Supply Voltage, V _{DD}	1.1	1.5	1.7	V	
Supply Current, I _{COIL} +I _{DD}		35 45	50 80	mA	V _{DD} =1.1V, V _{HON} =1.1V V _{DD} =1.5V, V _{HON} =1.5V
Coil Voltage, V _{COIL}	V _{DD}		1.7	V	
HON Input Voltage, V _{HON} LOW: EL off HIGH: EL on	-0.25 V _{DD} -0.25	0 V _{DD}	0.25V V _{DD} +0.25	V	
HON Current, EL on		3	15	μA	internal pulldown, V _{HON} =V _{DD} =1.5V
Shutdown Current, I _{SD} =I _{COIL} +I _{DD}		0.5	10	μA	V _{HON} =0V
INDUCTOR DRIVE					
Coil Frequency, f _{COIL}		28.8		kHz	
Coil Duty Cycle		90		%	
Peak Coil Current, I _{PK-COIL}			100	mA	Guaranteed by design.
EL LAMP OUTPUT					
EL Lamp Frequency, f _{LAMP}	150 300 150	450	500 550 750	Hz	T _{AMB} =+25°C, V _{DD} =1.1V T _{AMB} =+25°C, V _{DD} =1.5V T _{AMB} =-40°C to +85°C, V _{DD} =1.5V
Peak to Peak Output Voltage	90 120	120 160		V _{PP}	V _{DD} =1.1V V _{DD} =1.5V

PIN DESCRIPTION

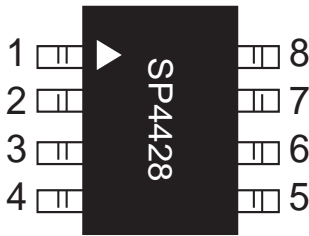

Pin 1 – C_{OSC} - Connect CAP from V_{SS} to Pin 1 to set Oscillator frequency.

Pin 2 – V_{SS} - Power supply common, connect to ground.

Pin 3 – Coil- Coil input, connect coil from $V_{BATTERY}$ to Pin 3.

Pin 4 – D1- Diode cathode connection.

Pin 5 – EL2- Lamp driver output1, connect to EL lamp.

Pin 6 – EL1- Lamp driver output2, connect to EL lamp.

Pin 7 – V_{DD} - Power supply for driver, connect to system V_{DD} .

Pin 8 – HON- Enable for driver operation, high = active; low = inactive.

THEORY OF OPERATION

The **SP4428** is made up of three basic circuit elements, an oscillator, coil, driver and switched H-bridge network. The oscillator provides the device with an on-chip clock source used to control the charge and discharge phases for the coil and lamp. An external capacitor connected between pins 1 and V_{SS} allows the user to vary the oscillator frequency. For a given choice of coil inductance there will be an optimum C_{OSC} Capacitor value that gives the maximum light output in a given lamp.

The suggested oscillator frequency is 28.8kHz ($C_{OSC}=180\text{pF}$). The oscillator output is internally divided to create the control signal f_{LAMP} . The oscillator output is internally divided down by 6 flip flops, a 28.8kHz signal will be divided into 6 frequency levels; 14.4kHz, 7.2kHz, 3.6kHz, 1.8kHz, 900Hz, and 450Hz. The oscillator output (28.8kHz) is used to drive the coil (see **figure 2** on **page 7**) and the sixth flip flop output (300Hz) is used to drive the lamp. Although the oscillator frequency can be varied to optimize the lamp output, the ratio of f_{COIL}/f_{LAMP} will always equal 64.

The coil is an external component connected from $V_{BATTERY}$ to pin 3 of the **SP4428**. Energy is developed in the coil according to the equation $E_L = 1/2LI^2$ where the current I is defined as $I = (V_{BATTERY} - IR - V_{OL})/R_T$. In order to maximize the

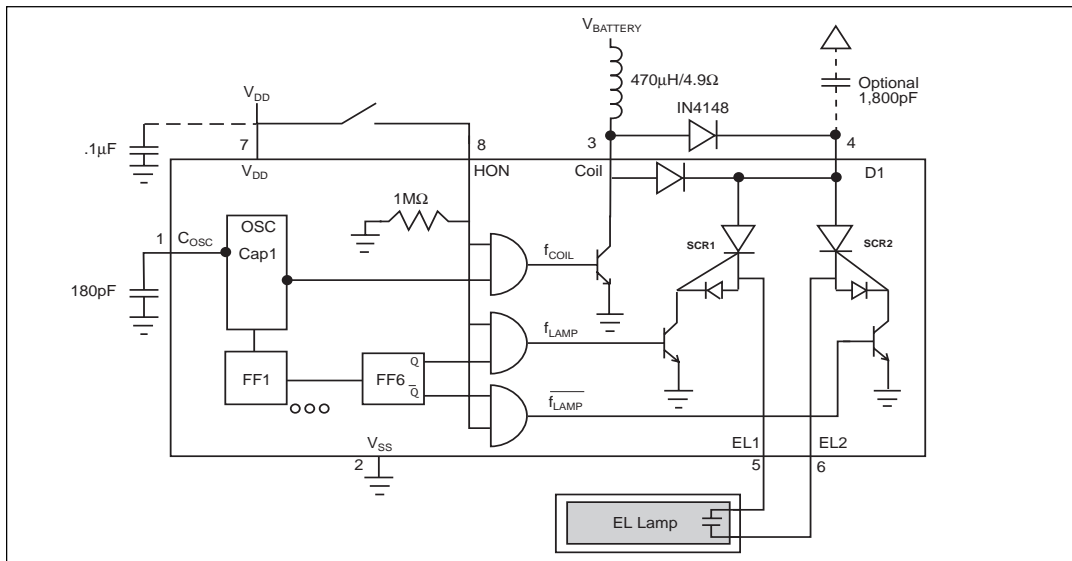

SP4428 Schematic

energy produced by the coil V_{BATTERY} should represent the largest voltage in the system (up to the maximum tolerance of the coil) and the coil should have low resistance; $V_{\text{BATTERY}} = 1.5 \text{ VDC}$ with a $470\mu\text{H}/4.9\Omega$ coil are typical. The majority of the current goes through the coil and typically less than 1mA is required for V_{DD} of the **SP4428**. V_{DD} can range from 1.5V to 1.7V ; it is not necessary that $V_{\text{DD}} = V_{\text{BATTERY}}$. Coils are also a function of the core material and winding used -- performance variances may be noticeable from different coil suppliers. The Sipex **SP4428** is final tested using a $470\mu\text{H}/4.9\Omega$ coil from Sumida. For suggested coil sources see [page 9](#).

The f_{COIL} signal controls a switch that connects the end of the coil at pin 3 to ground or to open circuit. The f_{COIL} signal is a 90% duty cycle signal switching at the oscillator frequency. During the time when the f_{COIL} signal is high, the coil is connected from V_{BATTERY} to ground and a charged magnetic field is created in the coil. During the low part of f_{COIL} , the ground connection is switched open, the field collapses and the energy in the inductor is forced to flow toward the lamp. f_{COIL} will send 32 of these charge pulses every half cycle (see [figure 2](#) on [page 7](#)) to the lamp, each pulse increases the voltage drop across the lamp in discrete steps. As the voltage potential approaches its maximum, the steps become smaller (see [figure 1](#) on [page 7](#)).

The H-bridge consists of two SCR structures that act as high voltage switches. These two switches control the polarity of how the lamp is charged. The SCR switches are controlled by the f_{LAMP} signal which is the oscillator frequency divided by 64. For a 20kHz oscillator, $f_{\text{LAMP}} = 300\text{Hz}$.

When the energy from the coil is released, a high voltage spike is created triggering the SCR switches. The direction of current flow is determined by which SCR is enabled. One full cycle of the H-bridge will create a voltage step from ground to 80V (typical) on pins 5 and 6 which are 180 degrees out of phase with each other (see [figure 3](#) on [page 7](#)). A differential view of the outputs is shown in [figure 4](#) on [page 7](#). If Line Noise is of concern it is advisable to add a decoupling cap at V_{DD} .

Electroluminescent Technology

What is electroluminescence?

An EL lamp is basically a strip of plastic that is coated with a phosphorous material which emits light (fluoresces) when a high voltage ($>40\text{V}$) which was first applied across it, is removed or reversed. Long periods of DC voltages applied to the material tend to breakdown the material and reduce its lifetime. With these considerations in mind, the ideal signal to drive an EL lamp is a high voltage sine wave. Traditional approaches to achieving this type of waveform included discrete circuits incorporating a transformer, transistors, and several resistors and capacitors. This approach is large and bulky, and cannot be implemented in most hand held equipment. **Sipex** now offers low power single chip driver circuits specifically designed to drive small to medium sized electroluminescent panels if all that is required is one external inductor fast recovery diode and two capacitors.

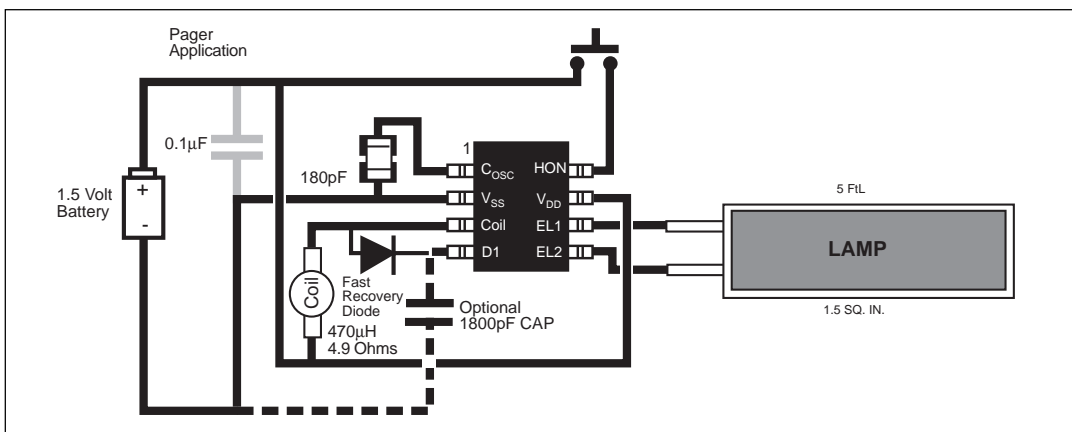

Typical SP4428 Application Circuit

Electroluminescent backlighting is ideal when used with LCD displays, keypads, or other backlit readouts. Its main use is to illuminate displays in dim to dark conditions for momentary periods of time. EL lamps typically consume less than LEDs or bulbs making them ideal for battery powered products. Also, EL lamps are able to evenly light an area without creating "hot spots" in the display.

The amount of light emitted is a function of the voltage applied to the lamp, the frequency at which it is applied, the lamp material used and its size. There are many variables which can be optimized for specific applications. **Sipex** supplies characterization charts to aid the designer in selecting the optimum circuit configuration (see *page 6* and *7*).

The following performance curves are intended to give the designer a relative scale from which to optimize specific applications. Absolute measurements may vary depending upon the brand of components chosen.

$V_{DD} = V_{COIL} = 1.5V$; coil = $470\mu H/4ohm$; $C_{OSC} = 180pf$; $C_{INT} = 1800pf$; $C_{LOAD} = 4.7nF$

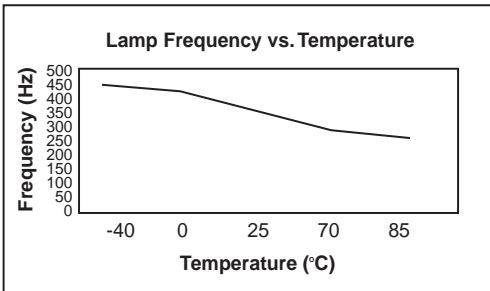
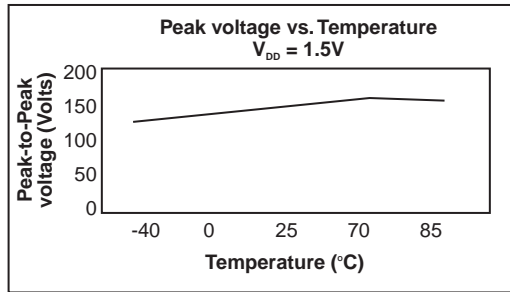
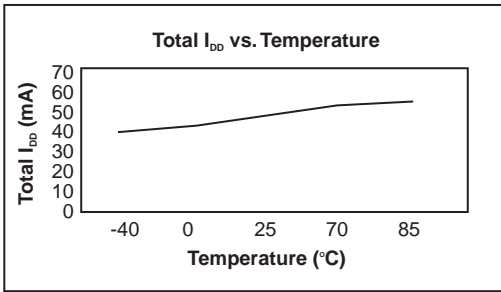

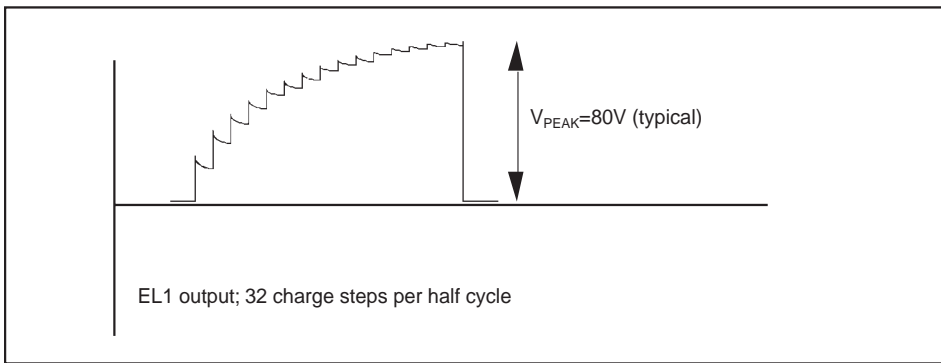

Figure 1. EL output voltage in discrete steps at EL1 output

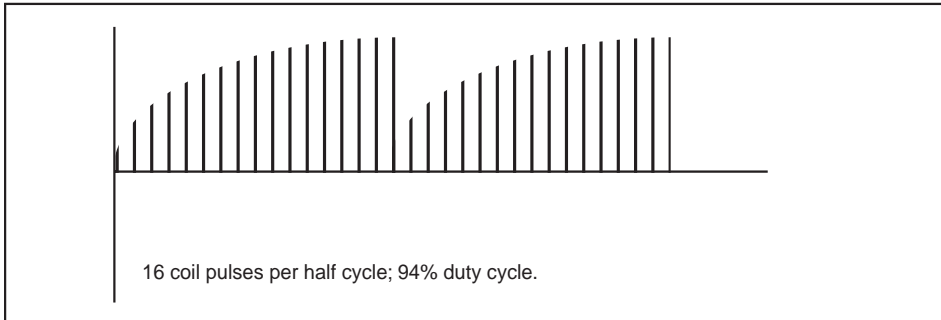

Figure 2. Voltage pulses released from the coil to the EL driver circuitry

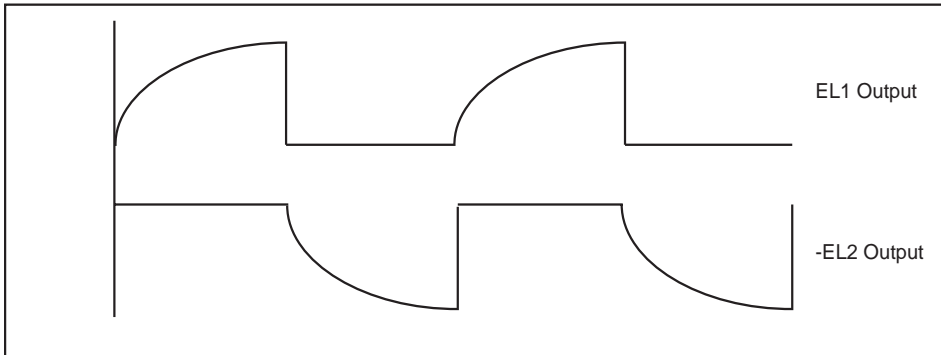

Figure 3. EL voltage waveforms from the EL1 and EL2 outputs

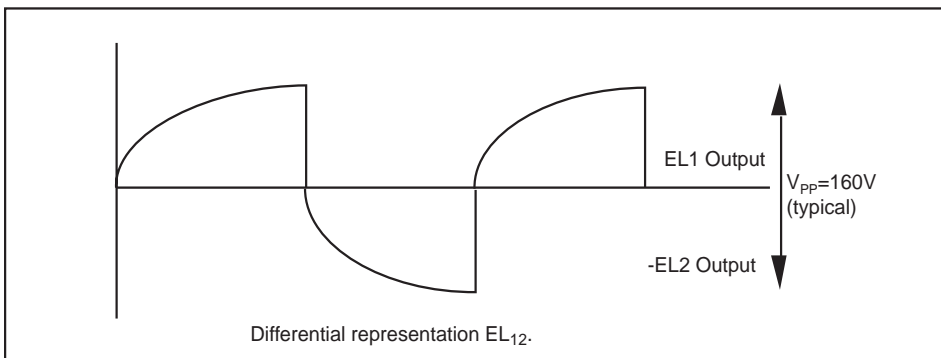
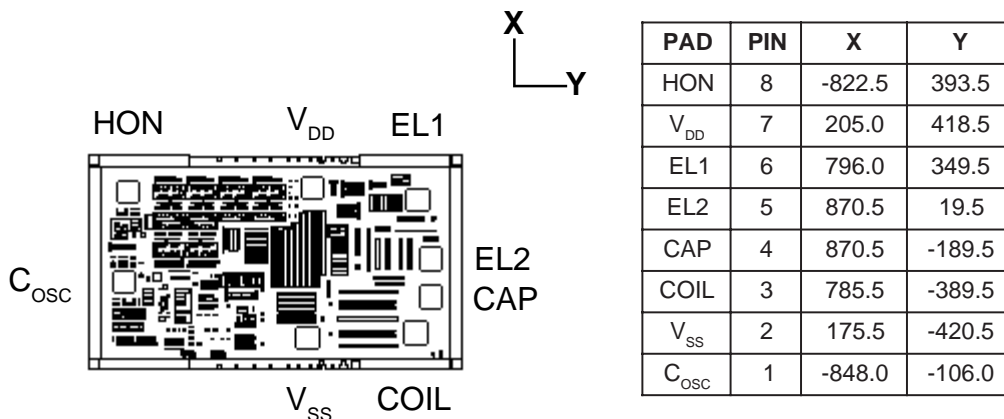

Figure 4. EL differential output waveform of the EL1 and EL2 outputs

BONDING DIAGRAM



NOTES:

1. Dimensions are in Microns unless otherwise noted.
2. Bonding pads are 125 X 125 typical.
3. Outside dimensions are maximum, including scribe area.
4. Die thickness is 380 ± 25 microns.
5. Pad center coordinates are relative to die center.
6. Die size (step size): 81 X 46 mils

Figure 5. Bonding Diagram

Coil Manufacturers

New Coils

Coilcraft USA

Ph: (847) 639-6400
Fax: (847) 639-1469

Coilcraft Taiwan

Ph: 886/2/264-3646
Fax: 886/2/270-0294

Coilcraft Hong Kong

Ph: 852 770-9428
Fax: 852 770-0729

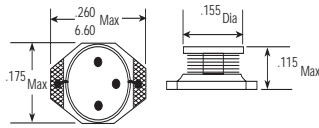

(All Dimensions in mm)

Coilcraft Europe

Ph: 44 01236 730595
Fax: 44 01236 730627

Coil Craft Singapore

Ph: 65 296-6933
Fax: 465 296-4463 #382

Part No. DO1608C-474
470µH, 3.60 ohm

muRata USA

Ph: (770) 436-1300
Fax: (770) 436-3030

muRata Taiwan Electronics

Ph: 011 88642914151
Fax: 011 88644252929

muRata Hong Kong

Ph: 011-85223763898
Fax: 011 852237555655

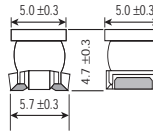

(All Dimensions in mm)

muRata Europe

Ph: 011-4991166870
Fax: 011-49116687225

muRata Electronics Singapore

Ph: 011 657584233
Fax: 011 657536181

Part No. LQN4N471K04
470µH, 11.5 ohm

KOA Speer Electronics, Inc.

Ph: 814-362-5536
Fax: 814-362-8883

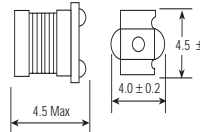

(All Dimensions in mm)

Part No. LPC4045TE471K
470µH, 4.55 ohm

Sumida Electric Co., LTD. USA

Ph: (847) 956-0666
Fax: (847) 956-0702

Sumida Electric Co., LTD. Singapore

Ph: 2963388
Fax: 2963390

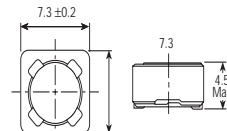

(All Dimensions in mm)

Sumida Electric Co., LTD. Japan

Ph: 03-3607-5111
Fax: 03-3607-5144

Sumida Electric Co., LTD. Hong Kong

Ph: 28806688
Fax: 25659600

Part No. CDRH74-471MC
470µH, 3.01 ohm

Toko America Inc. USA

Ph: (847) 297-0070
Fax: (847) 699-7864

Toko Inc. Japan

Ph: 03 3727 1161
Fax: 03 3727 1176

Toko Inc. Hong Kong

Ph: 2342-8131
Fax: 2341-9570

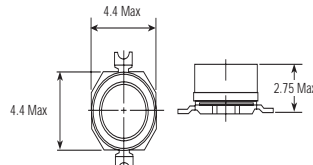

(All Dimensions in mm)

Toko Inc. Europe

Ph: (0211) 680090
Fax: (0211) 679-9567

Toko Inc. Singapore

Ph: (255) 4000
Fax: (250) 8134

Part No. 667MA471N
470µH, 1.90 ohm

EL polarizers/translector manufacturers

Nitto Denko
Yoshi Shinozuka
Bayside Business Park 48500
Fremont, CA 94538
Phone: 510 445-5400
Fax: 510 445-5480

Top Polarizer- NPF F1205DU
Bottom - NPF F4225
or (F4205) P3 w/translector

Translector Material
Astra Products
Mark Bogin
P.O. Box 479
Baldwin, NJ 11510
Phone (516)-223-7500
Fax (516)-868-2371

EL Lamp manufacturers

Leading Edge Ind. Inc.
11578 Encore Circle
Minnetonka, MN 55343
Phone 1-800-845-6992

Midori Mark Ltd.
1-5 Komagata 2-Chome
Taita-Ku 111-0043 Japan
Phone: 81-03-3848-2011

Luminescent Systems inc. (LSI)
101 Etna Road
Lebanon, NH. 03766-9004
Phone: (603) 448-3444
Fax: (603) 448-33452

NEC Corporation
Yumi Saskai
7-1, Shiba 5 Chome, Minato-ku,
Tokyo 108-01, Japan
Phone: (03) 3798-9572
Fax: (03) 3798-6134

Seiko Precision
Shuzo Abe
1-1, Taihei 4-Chome,
Sumida-ku, Tokyo, 139 Japan
Phone: (03) 5610-7089
Fax: (03) 5610-7177

Gunze Electronics
2113 Wells Branch Parkway
Austin, TX 78728
Phone: (512) 752-1299
Fax: (512) 252-1181

All package dimensions in inches
8-pin NSOIC

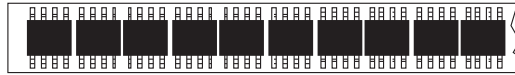
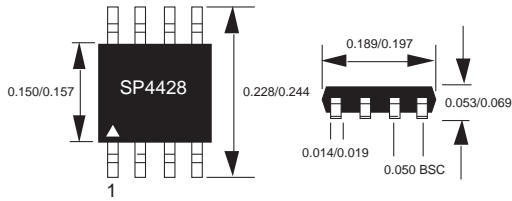

95 NSOIC SP4428 per tube, no minimum quantity

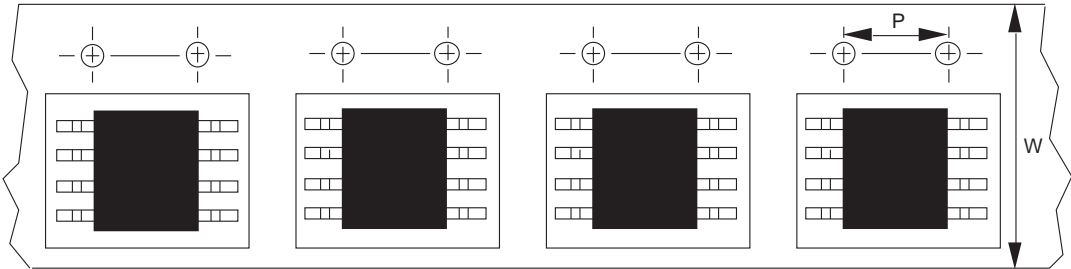

NSOIC-8 13" reels: P=8mm, W=12mm			
Pkg.	Minimum qty per reel	Standard qty per reel	Maximum qty per reel
CN	500	2500	3000

ORDERING INFORMATION

Model	Temperature Range	Package Type
SP4428CN	0°C to +70°C	8-Pin NSOIC
SP4428NEB		NSOIC Evaluation Board

Please consult the factory for pricing and availability on a Tape-On-Reel option.



SIGNAL PROCESSING EXCELLENCE

Sipex Corporation

Headquarters and Sales Office

22 Linnell Circle
Billerica, MA 01821
TEL: (978) 667-8700
FAX: (978) 670-9001
e-mail: sales@sipex.com

Sales Office

233 South Hillview Drive
Milpitas, CA 95035
TEL: (408) 934-7500
FAX: (408) 935-7600

Sipex Corporation reserves the right to make changes to any products described herein. Sipex does not assume any liability arising out of the application or use of any product or circuit described herein; neither does it convey any license under its patent rights nor the rights of others.