



SDU/D3055L2

N-Channel Enhancement Mode Field Effect Transistor

PRODUCT SUMMARY		
V _{DSS}	I _D	R _{DS(ON)} (mΩ) TYP
20V	15A	34 @ V _{GS} = 4.5V
		45 @ V _{GS} = 2.5V

FEATURES

- Super high dense cell design for low R_{DS(ON)}.
- Rugged and reliable.
- TO-252 and TO-251 Package.

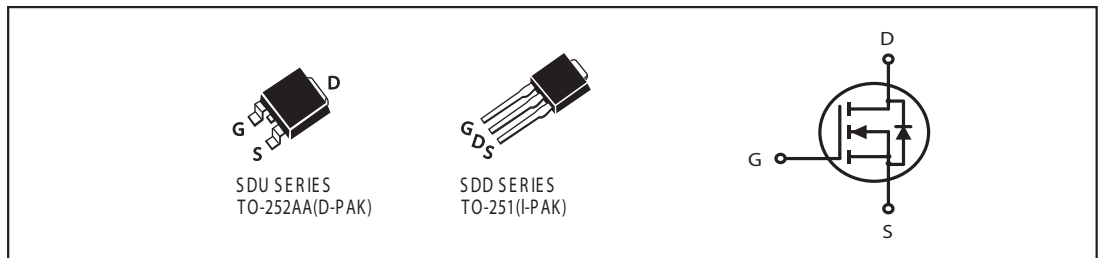

ABSOLUTE MAXIMUM RATINGS (T_A=25 °C unless otherwise noted)

Parameter	Symbol	Limit	Unit
Drain-Source Voltage	V _{DS}	20	V
Gate-Source Voltage	V _{GS}	±12	V
Drain Current-Continuous ^a @ T _J =125 °C -Pulsed ^b (300ms Pulse Width)	I _D	15	A
	I _{DM}	45	A
Drain-Source Diode Forward Current ^a	I _S	15	A
Maximum Power Dissipation ^a	P _D	50	W
Operating Junction and Storage Temperature Range	T _J , T _{STG}	-55 to 150	°C

THERMAL CHARACTERISTICS

Thermal Resistance, Junction-to-Case	R _{θJC}	3	°C/W
Thermal Resistance, Junction-to-Ambient	R _{θJA}	50	°C/W

SDU/D3055L2

ELECTRICAL CHARACTERISTICS (T_A =25 °C unless otherwise noted)

Parameter	Symbol	Condition	Min	Typ ^c	Max	Unit
OFF CHARACTERISTICS						
Drain-Source Breakdown Voltage	BV _{DSS}	V _{GS} =0V, I _D =250uA	20			V
Zero Gate Voltage Drain Current	I _{DSS}	V _{DS} =20V, V _{GS} =0V			1	uA
Gate-Body Leakage	I _{GSS}	V _{GS} =± 8V, V _{DS} =0V			±100	nA
ON CHARACTERISTICS^b						
Gate Threshold Voltage	V _{GS(th)}	V _{DS} =V _{GS} , I _D = 250uA	0.7			V
Drain-Source On-State Resistance	R _{DS(ON)}	V _{GS} =4.5V, I _D = 6.0A		34	60	m-ohm
		V _{GS} =2.5V, I _D = 5.2A		45	70	m-ohm
On-State Drain Current	I _{D(ON)}	V _{DS} = 5V, V _{GS} = 4.5V	20			A
Forward Transconductance	g _{FS}	V _{DS} = 10V, I _D =6.0A		17		S
DYNAMIC CHARACTERISTICS^c						
Input Capacitance	C _{ISS}	V _{DS} =8V, V _{GS} = 0V f =1.0MHz		705		pF
Output Capacitance	C _{OSS}			280		pF
Reverse Transfer Capacitance	C _{RSS}			65		pF
SWITCHING CHARACTERISTICS^c						
Turn-On Delay Time	t _{D(ON)}	V _{DD} = 10V, I _D = 1A, V _{GEN} = 4.5V, R _L = 10 ohm R _{GEN} = 6 ohm		10	20	ns
Rise Time	t _r			15	30	ns
Turn-Off Delay Time	t _{D(OFF)}			35	60	ns
Fall Time	t _f			20	40	ns
Total Gate Charge	Q _g	V _{DS} =10V, I _D =6A, V _{GS} =10V		25	30	nC
		V _{DS} =10V, I _D =6A, V _{GS} =4.5V		9.3	11.5	nC
Gate-Source Charge	Q _{gs}	V _{DS} =10V, I _D = 6A, V _{GS} =10V		2		nC
Gate-Drain Charge	Q _{gd}			2		nC

S DU/D3055L 2

ELECTRICAL CHARACTERISTICS ($T_A=25^\circ\text{C}$ unless otherwise)

Parameter	Symbol	Condition	Min	Typ ^c	Max	Unit
DRAIN-SOURCE DIODE CHARACTERISTICS^b						
Diode Forward Voltage	V_{SD}	$V_{GS} = 0V, I_s = 1.7A$		0.72	1.2	V

Notes

- a. Surface Mounted on FR4 Board, $t \leq 10\text{sec}$.
- b. Pulse Test: Pulse Width $\leq 300\mu\text{s}$, Duty Cycle $\leq 2\%$.
- c. Guaranteed by design, not subject to production testing.

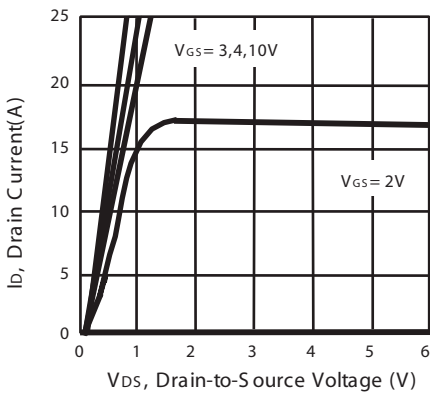

Figure 1. Output Characteristics

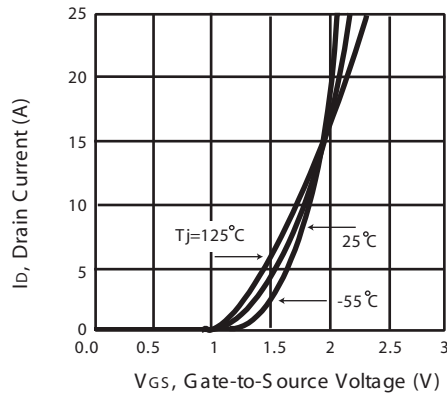

Figure 2. Transfer Characteristics

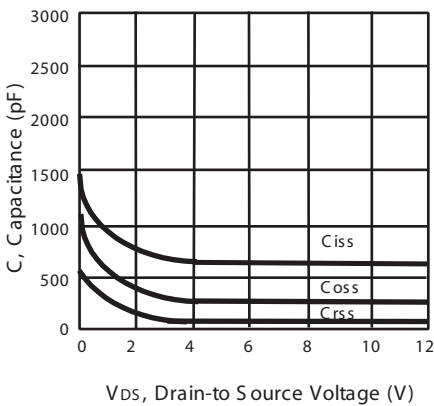

Figure 3. Capacitance

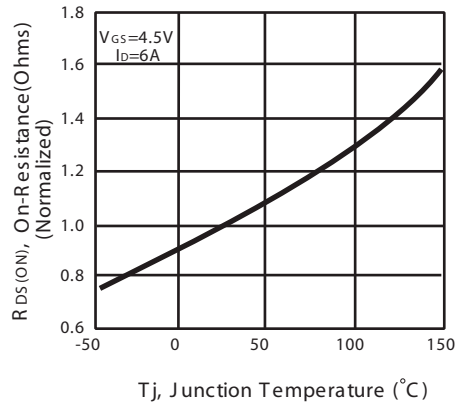

Figure 4. On-R resistance Variation with Temperature

SDU/D3055L2

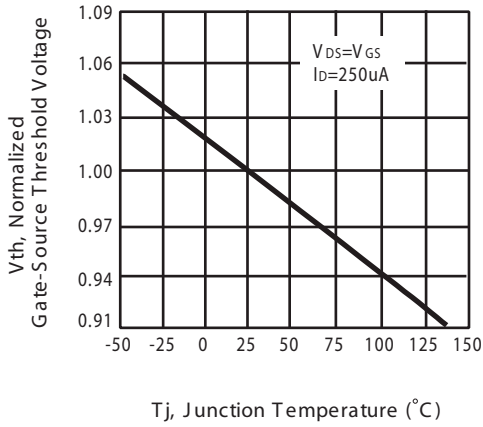

Figure 5. Gate Threshold Variation with Temperature

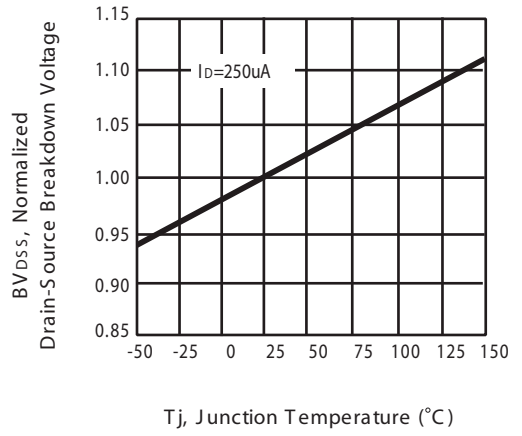

Figure 6. Breakdown Voltage Variation with Temperature

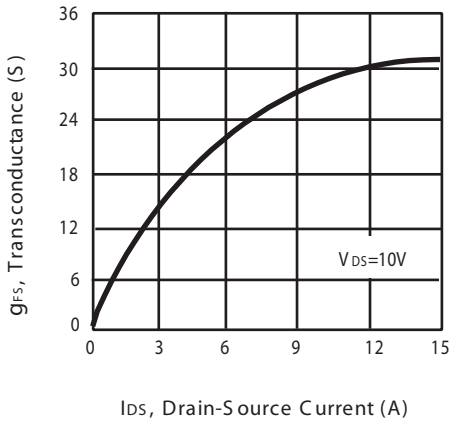

Figure 7. Transconductance Variation with Drain Current

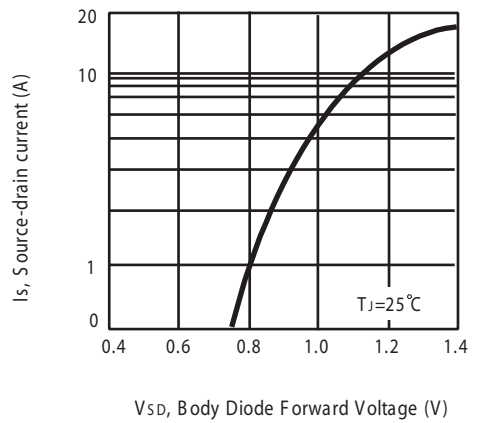

Figure 8. Body Diode Forward Voltage Variation with Source Current

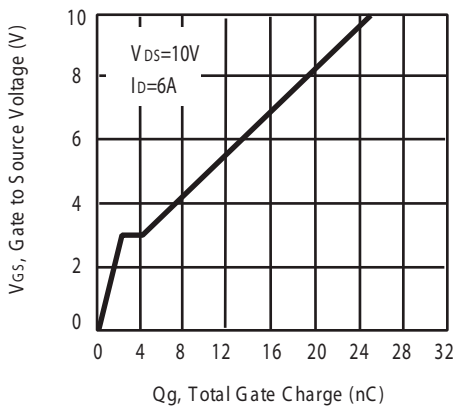

Figure 9. Gate Charge

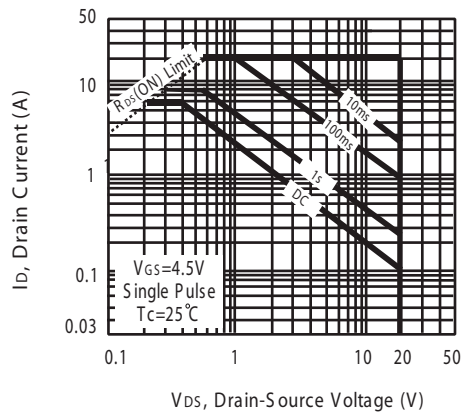

Figure 10. Maximum Safe Operating Area

S DU/D3055L 2

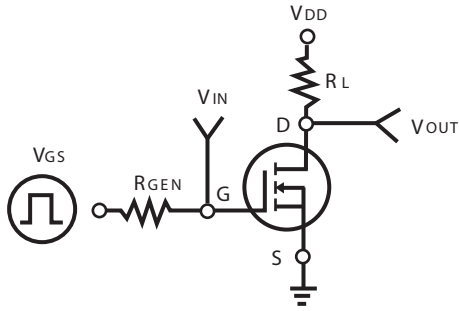

Figure 11. Switching Test Circuit

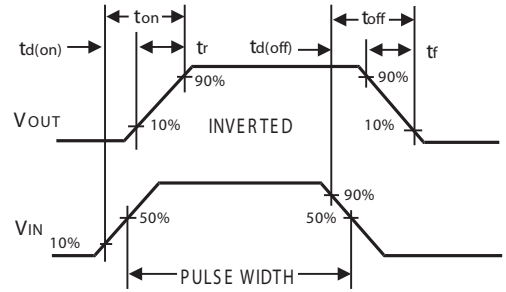

Figure 12. Switching Waveforms

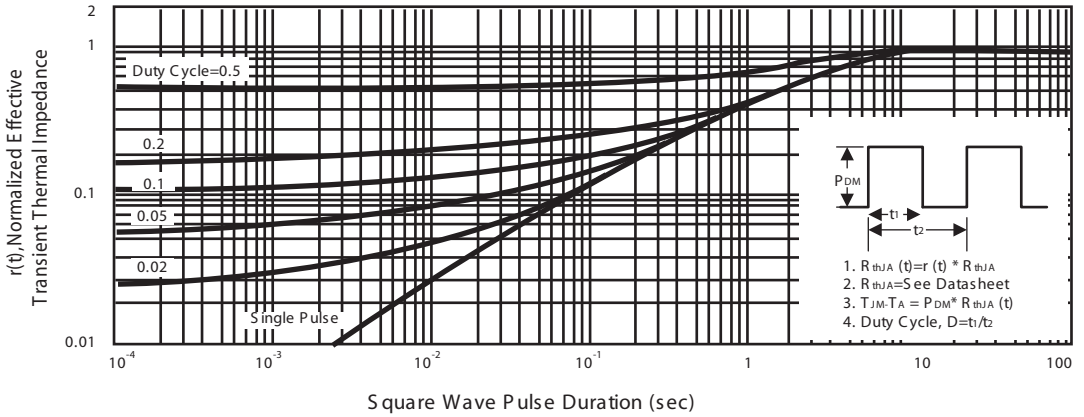

Figure 13. Normalized Thermal Transient Impedance Curve