



## GENERAL DESCRIPTION

SM5172 is a remote control decoder paired with SM5162 utilizing CMOS Technology. It has 12-bit tri-state address pins providing a maximum of 531,411 (or 3<sup>12</sup>) address codes; thereby, drastically reducing any code collision and unauthorized code scanning possibilities. SM5172 is available in several options to suit every application needs : variable number of data output pins, latch or momentary output type.

## FEATURES

- \* CMOS Technology
- \* Low power consumption
- \* Very high noise immunity
- \* Up to 12 tri-State code address pins
- \* Up to 6 data pins
- \* Wide range of operating voltage:  
Vcc= 3 ~ 12 Volts
- \* Single resistor oscillator
- \* Latch or momentary output type
- \* Available in DIP and SOP package

## APPLICATIONS

- \* Car security
- \* Garage door
- \* Home security/Automation system
- \* Toys
- \* Remote control for industrial use

## BLOCK DIAGRAM

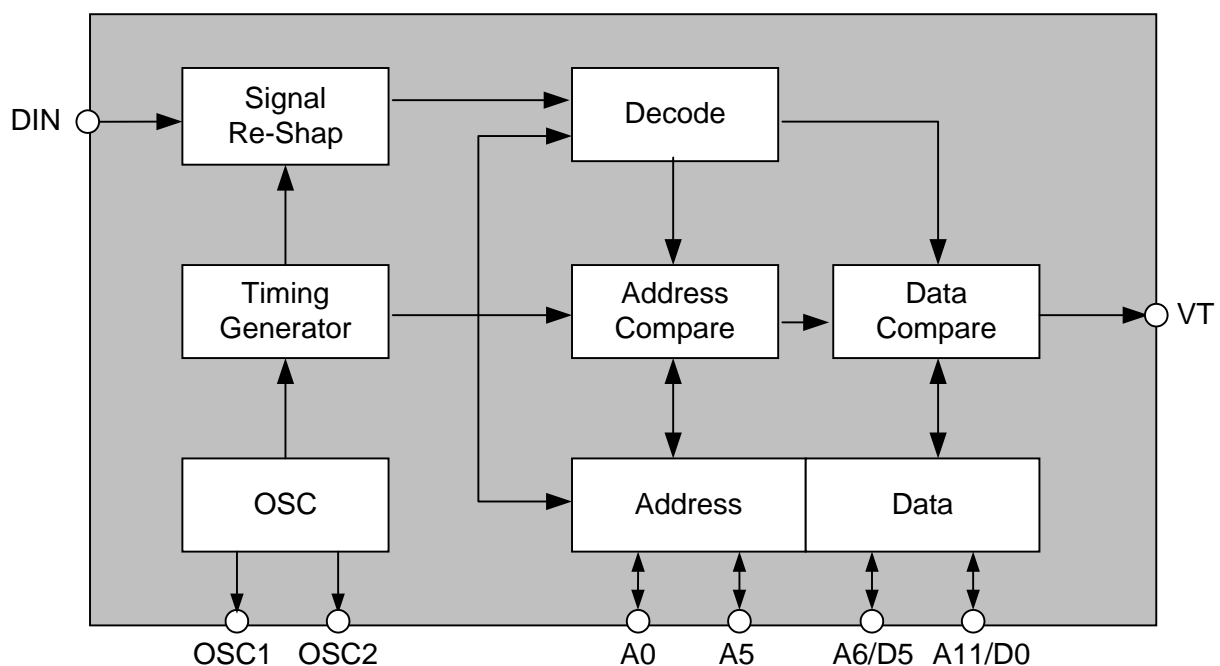



PIN ASSIGNMENTS ( DIP )

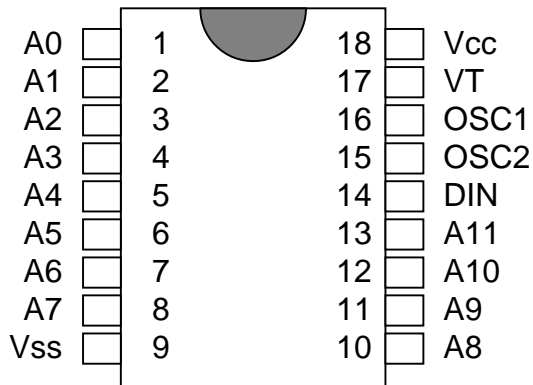

SM5172

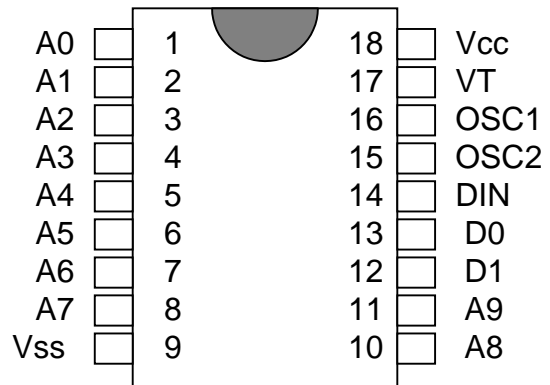

SM5172-M2/L2

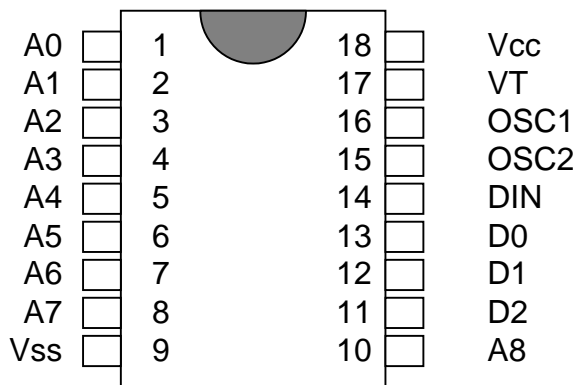

SM5172-M3/L3

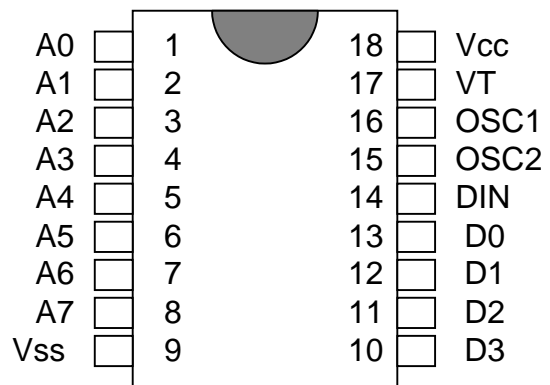

SM5172-M4/L4

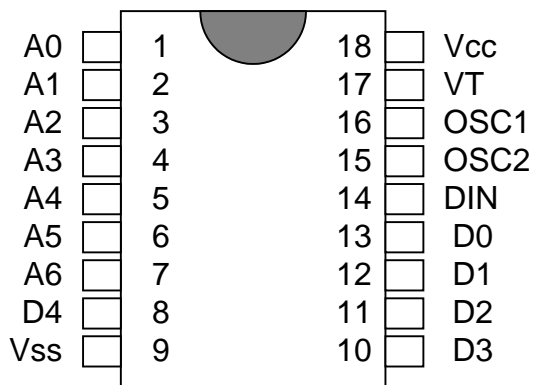

SM5172-M5/L5

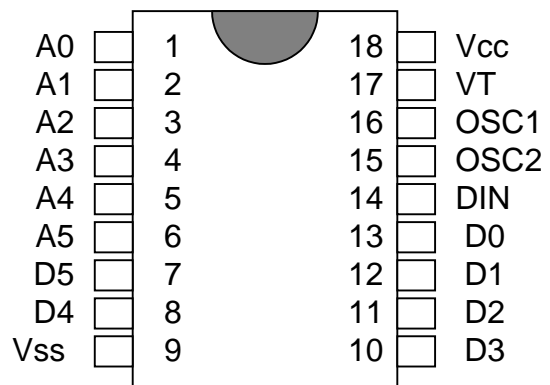

SM5172M6/L6



PIN CONFIGURATION ( SOP )

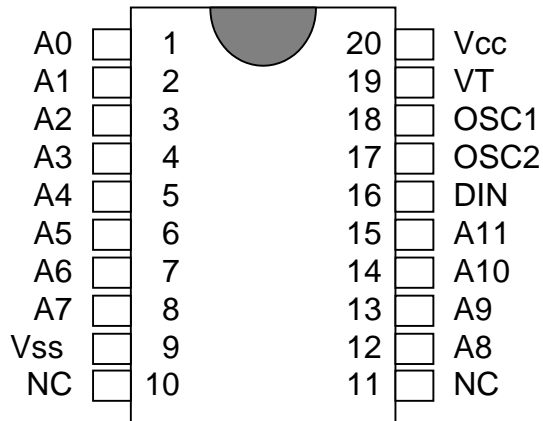

SM5172S

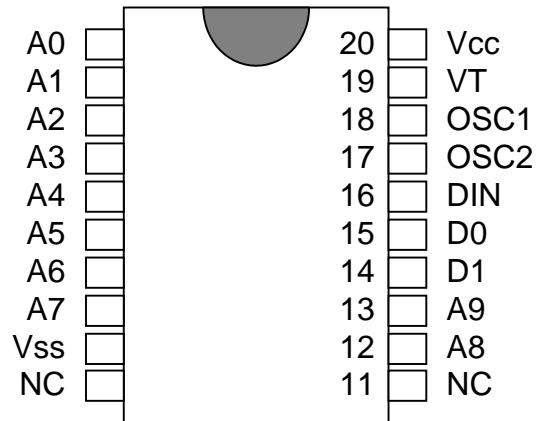

SM5172S-M2/L2

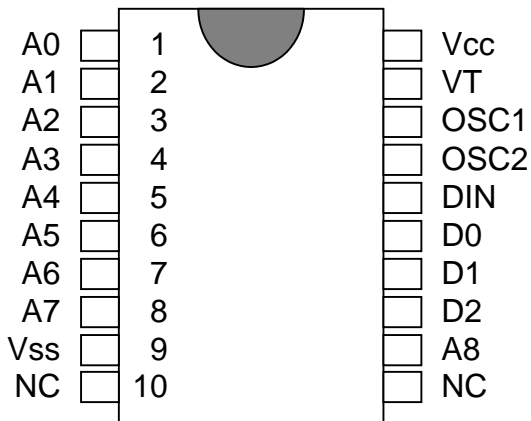

SM5172S-M3/L3

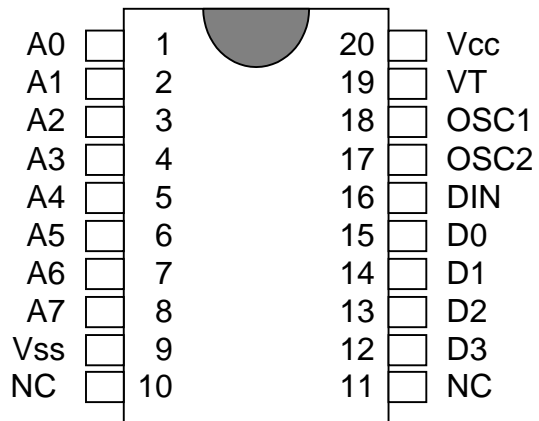

SM5172S-M4/L4

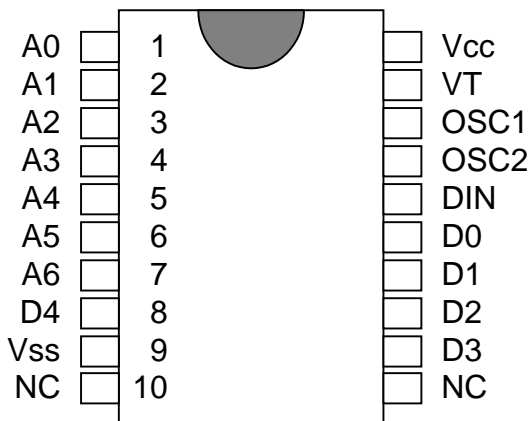

SM5172S-M5/L5

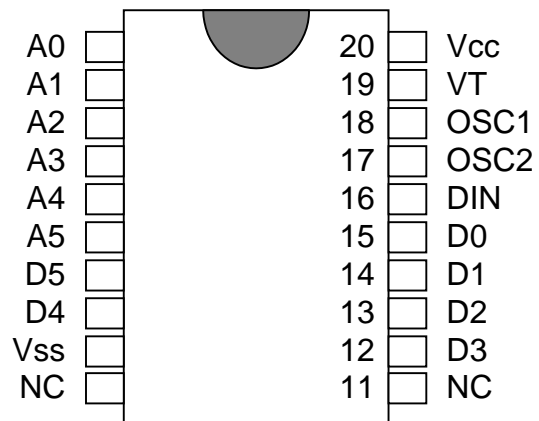

SM5172S-M6/L6



## PIN FUNCTION

No.	Pin Name	I/O	Function
1	A0	I	Address input, each pin can be set to "0", "1", or floating.
2	A1	I	
3	A2	I	
4	A3	I	
5	A4	I	
6	A5	I	
7	A6/D5	I / O	Address input or data output.
8	A7/D4	I / O	
9	Vss	POWER	Negative power supply.
10	A8/D3	I / O	Address input or data output.
11	A9/D2	I / O	
12	A10/D1	I / O	
13	A11/D0	I / O	
14	DIN	I	Receive from Rf module.
15	OSC1	I	Resistor connected between these two pins determine the system clock.
16	OSC2	O	
17	VT	O	Valid transmission indication.
18	VDD	POWER	Positive power supply.



## Code Word

A group of Code Bits is called a code Word. A Code Word consists of 12 Address plus Data bits followed by one Sync Bit. The 12 AD bits are interpreted as either address or data bits depending on the SM5172 version used. Please refer to the diagrams below:

### SM5172



### SM5172-M2/L2

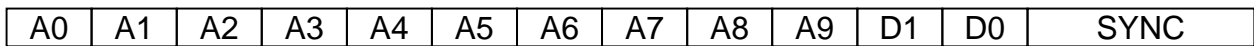

### SM5172-M3/L3

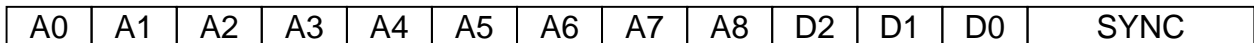

### SM5172-M4/L4

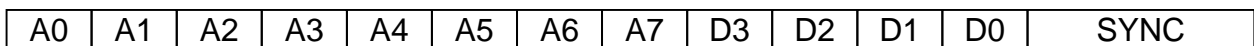

### SM5172-M5/L5

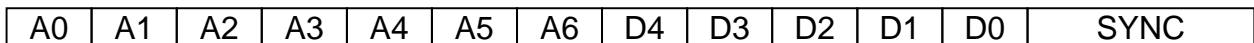

### SM5172-M6/L6

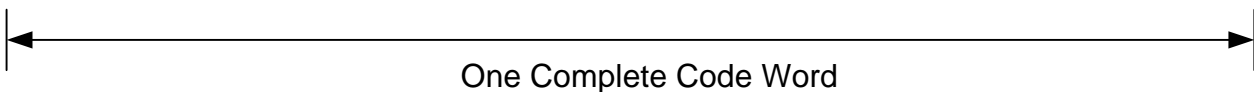
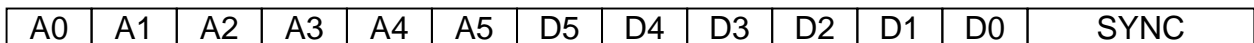



### Valid Transmission

After Power On SM5172 enters the Search Address mode, if SM5172 finds 2 consecutive Address that matches the Address Pin setting of SM5172 then it will set VT high.

If VT is set high, SM5172 is still in search Address. After 2 consecutive Address that do not match the setting on SM5172, SM5172 will disable VT.

The timing are shown in the following diagram.

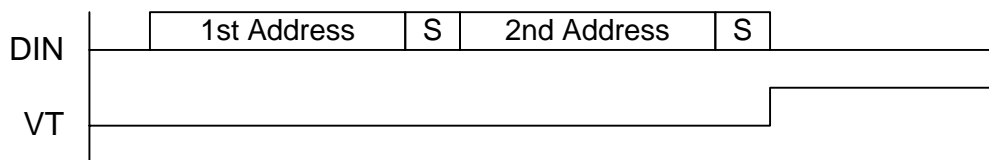

### Latch or Momentary Data Output Type

After Power On SM5172 is set in Address search mode, if SM5172 finds 2 consecutive Address that matches the Address setting of SM5172. SM5172 will enter Data Compare mode. It will compare perviously 2 receive data, if they match each then SM5172 will set VT high and send data O/P.

SM5172 re-enters Address search mode, after 2 consecutive Address that do not match the setting on SM5172 will disable VT and momentary's data but keep Latch's data intact.

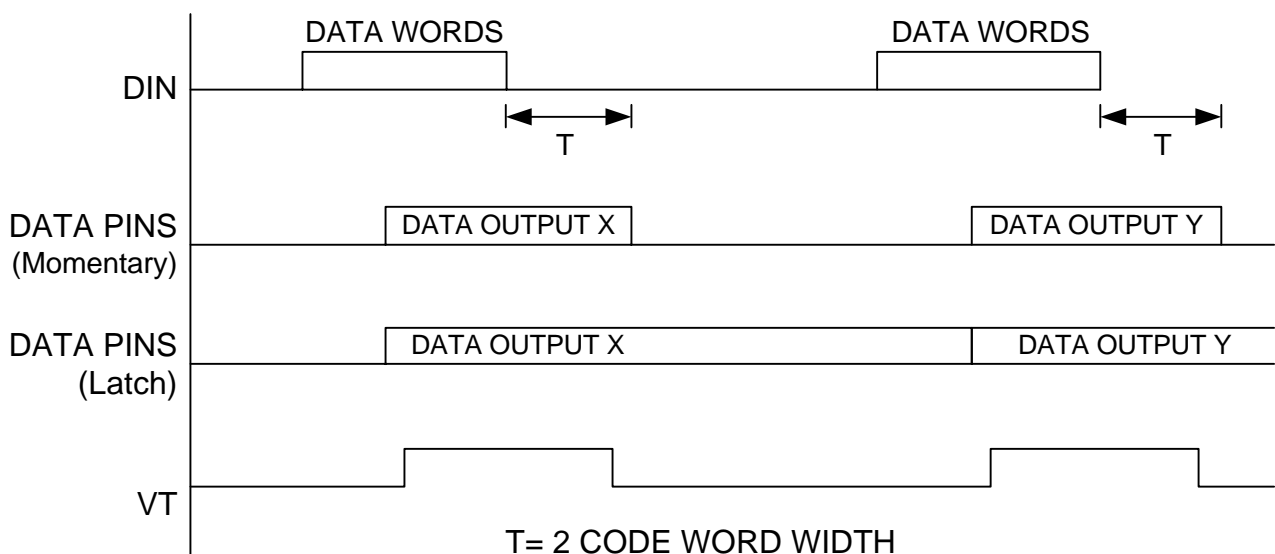



**OPERATION FLOWCHART**

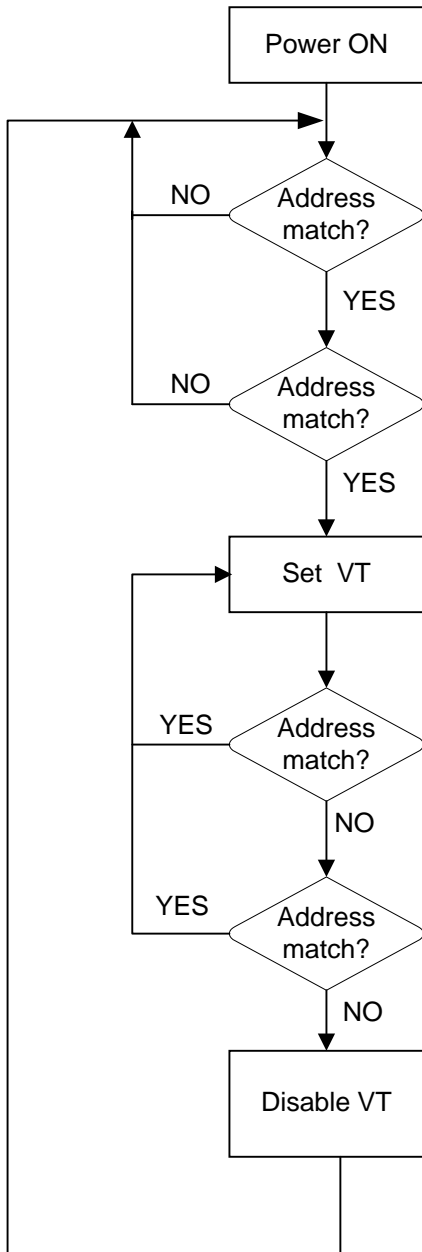

After Power On SM5172 enters the Search Address mode, if SM5172 finds 2 consecutive Address that matches the Address Pin setting of SM5172, it will set VT high.

It VT is set high, SM5172 is still in search Address. After 2 consecutive Address that do not match the setting on SM5172, SM5172 will disable VT.



## DECODER WITH DATA OUTPUT PINS

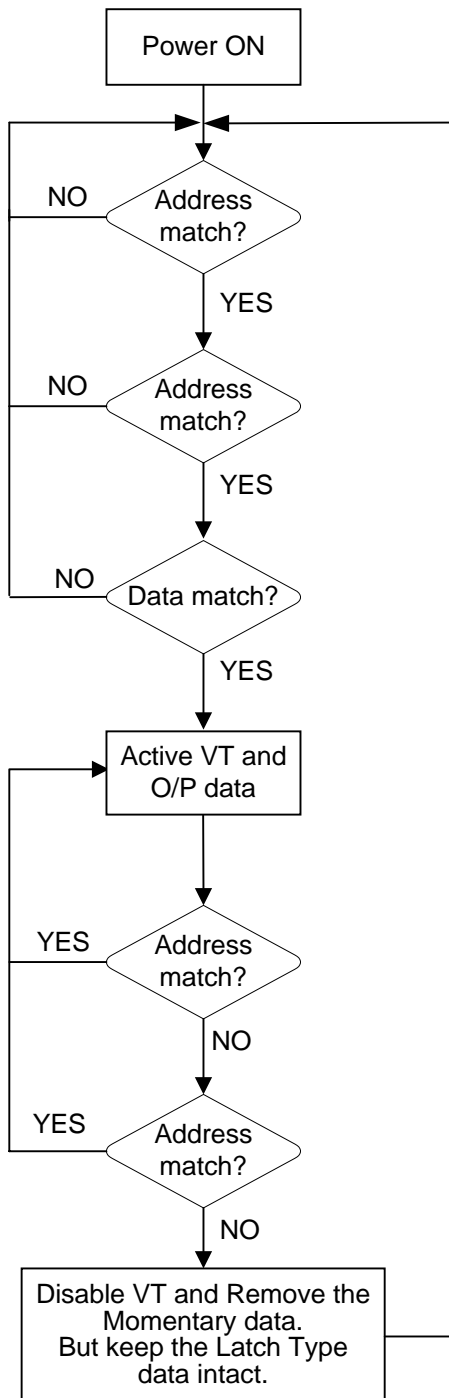

After Power On SM5172 is set in Address search mode, if SM5172 finds 2 consecutive Address that matches the Address setting of SM5172.

SM5172 will enter Data Compare mod. It will compare previously 2 received data, if they match then SM5172 will set VT high and send data O/ P.

SM5172 re-enters Address search mode, after 2 consecutive Address that do not match setting on SM5172 will disable VT and momentary's data but keep Latch's data intact.





### Single Resistor Oscillator

SM5172's oscillator be constructed by connecting a resistor between OSC1 and OSC2 pin.  
SM5172's OSC frequency must be 1.8 to 5.8 times more than SM5162.

Encoder OSC Frequency

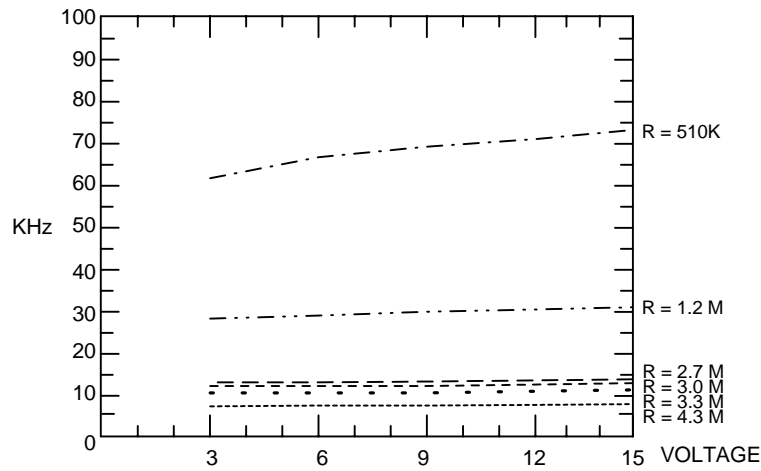

Dncoder OSC Frequency

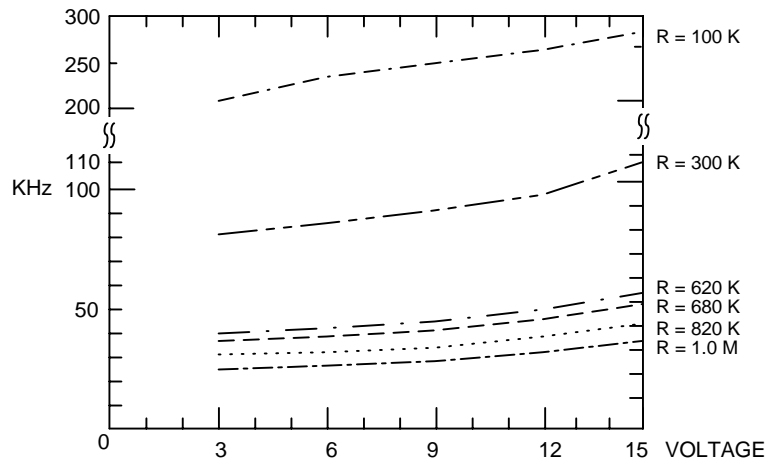

Suggested oscillator resistor of SM5162/ SM5172:

SM5162	SM5172
4.7M OHM	820K OHM
3.0M OHM	620K OHM
2.2M OHM	300K OHM
1.2M OHM	180K OHM



## DC ELECTRICAL CHARACTERISTICS

Parameter	Symbol	Conditions	Limit			Unit
			Min.	Typ.	Max.	
Supply Voltage	V <sub>CC</sub>		3		12	V
Standby Current	I <sub>STB</sub>	V <sub>CC</sub> = 12 V OSC stop A0 ~ A11 open		0.02	0.3	μA
Data Output Driving Current	I <sub>OH</sub>	V <sub>CC</sub> = 5V V <sub>OH</sub> = 4V	-4			mA
		V <sub>CC</sub> = 8V V <sub>OH</sub> = 6.4V	-8			mA
		V <sub>CC</sub> = 12V V <sub>OH</sub> = 9.6V	-15			mA
Data Output Sinking Current	I <sub>OL</sub>	V <sub>CC</sub> = 5V V <sub>OH</sub> = 1V	6			mA
		V <sub>CC</sub> = 8V V <sub>OH</sub> = 1.6V	14			mA
		V <sub>CC</sub> = 12V V <sub>OH</sub> = 2.4V	26			mA



**APPLICATION CIRCUIT**

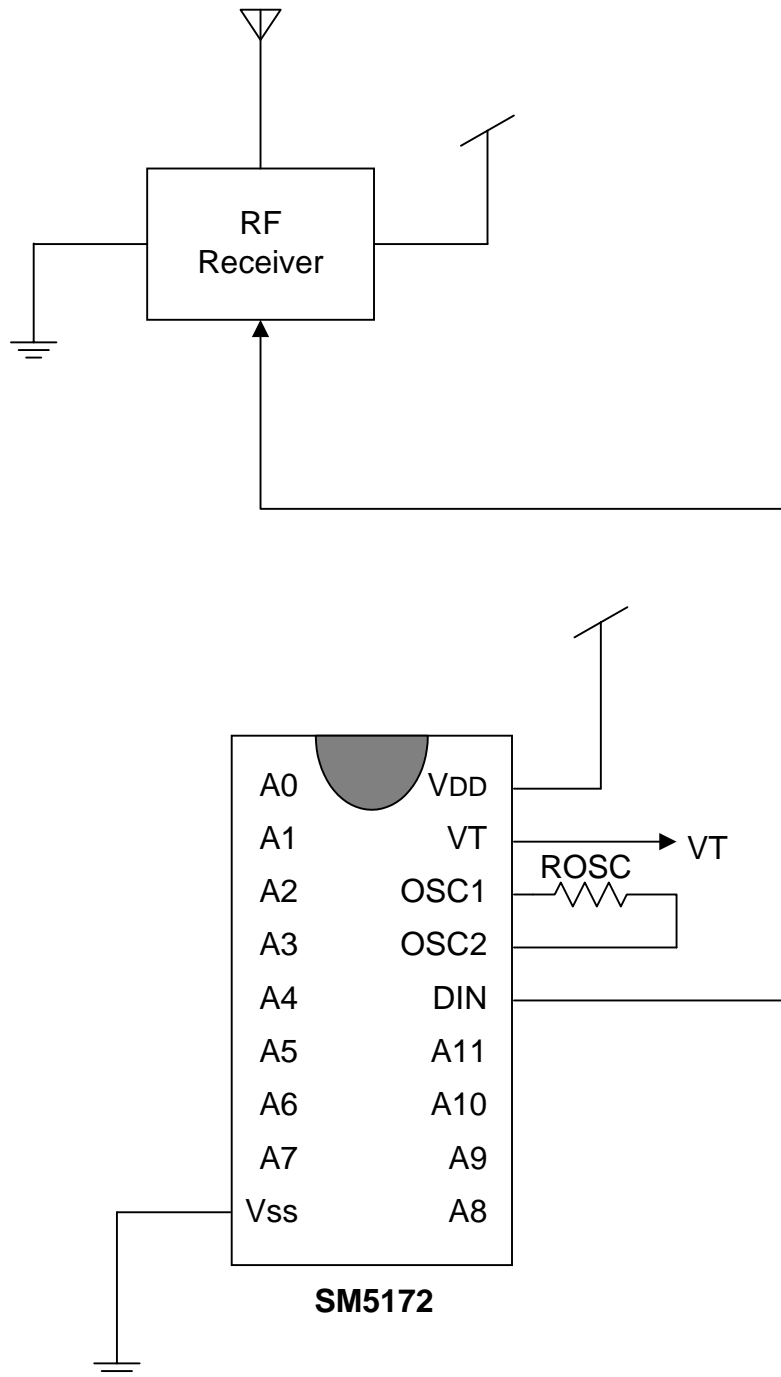



**ORDERING INFORMATION**

Part No.	Package
SM5172	18 Pin DIP

Part No.	Package
SM5172S	20 Pin SOP

