

## Silicon Switching Diodes

**BAS 19**  
**... BAS 21**

- High-speed, high-voltage switch

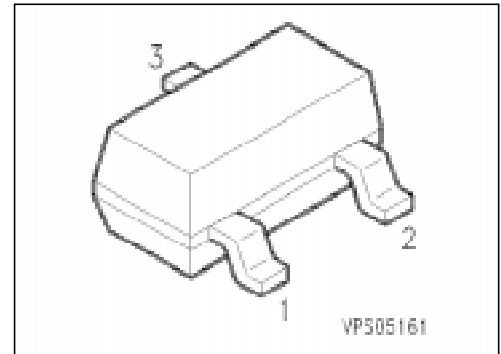
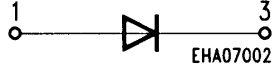

Type	Marking	Ordering Code (tape and reel)	Pin Configuration	Package <sup>1)</sup>
BAS 19 BAS 20 BAS 21	JPs JRs JSs	Q62702-A95 Q62702-A113 Q62702-A79		SOT-23

### Maximum Ratings

Parameter	Symbol	Values			Unit
		BAS 19	BAS 20	BAS 21	
Reverse voltage	$V_R$	100	150	200	V
Peak reverse voltage	$V_{RM}$	120	200	250	
Forward current	$I_F$	250			mA
Peak forward current	$I_{FM}$	625			
Total power dissipation, $T_s = 70\text{ °C}$	$P_{tot}$	350			mW
Junction temperature	$T_j$	150			°C
Storage temperature range	$T_{stg}$	- 65 ... + 150			

### Thermal Resistance

Junction - ambient <sup>2)</sup>	$R_{th\ JA}$	≤ 300	K/W
Junction - soldering point	$R_{th\ JS}$	≤ 230	

<sup>1)</sup> For detailed information see chapter Package Outlines.

<sup>2)</sup> Package mounted on epoxy pcb 40 mm × 40 mm × 1.5 mm/6 cm<sup>2</sup> Cu.

## Electrical Characteristics

at  $T_A = 25\text{ }^\circ\text{C}$ , unless otherwise specified.

Parameter	Symbol	Values			Unit
		min.	typ.	max.	

### DC characteristics

Breakdown voltage <sup>1)</sup> $I_{(BR)} = 100\text{ }\mu\text{A}$	BAS 19 BAS 20 BAS 21	$V_{(BR)}$	120 200 250	— — —	— — —	V
Forward voltage $I_F = 100\text{ mA}$ $I_F = 200\text{ mA}$		$V_F$	— —	— —	1 1.25	
Reverse current $V_R = V_{R\text{ max}}$ $V_R = V_{R\text{ max}}$ ; $T_j = 150\text{ }^\circ\text{C}$		$I_R$	— —	— —	100 100	nA $\mu\text{A}$

### AC characteristics

Diode capacitance $V_R = 0\text{ V}$ , $f = 1\text{ MHz}$		$C_D$	—	—	5	pF
Reverse recovery time $I_F = 30\text{ mA}$ , $I_R = 30\text{ mA}$ , $R_L = 100\text{ }\Omega$ measured at $I_R = 3\text{ mA}$		$t_{rr}$	—	—	50	ns

### Test circuit for reverse recovery time

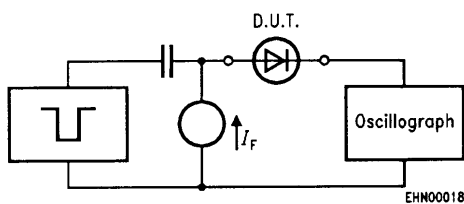

Pulse generator:  $t_p = 100\text{ ns}$ ,  $D = 0.05$   
 $t_r = 0.6\text{ ns}$ ,  $R_j = 50\text{ }\Omega$

Oscilloscope:  $R = 50\text{ }\Omega$   
 $t_r = 0.35\text{ ns}$   
 $C \leq 1\text{ pF}$

<sup>1)</sup> Pulse test:  $t_p \leq 300\text{ }\mu\text{s}$ ,  $D = 2\text{ }\%$ .

### Forward current $I_F = f(T_A^*; T_S)$

\* Package mounted on epoxy

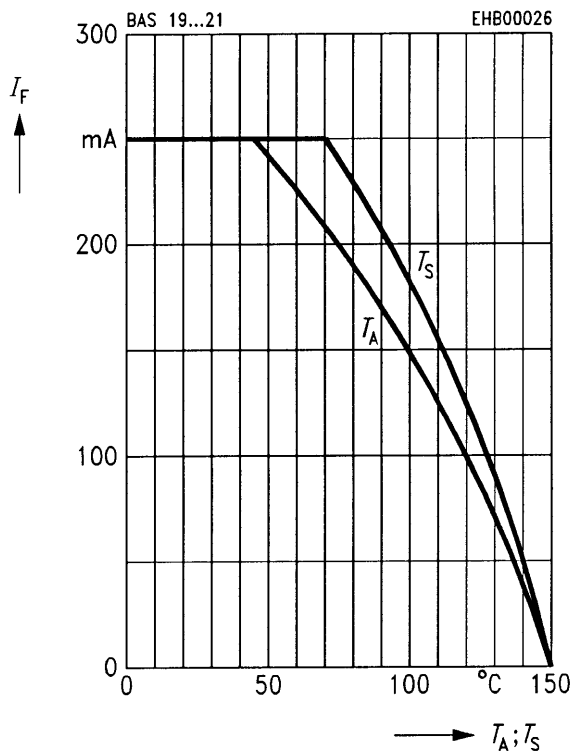

### Reverse current $I_R = f(T_A)$

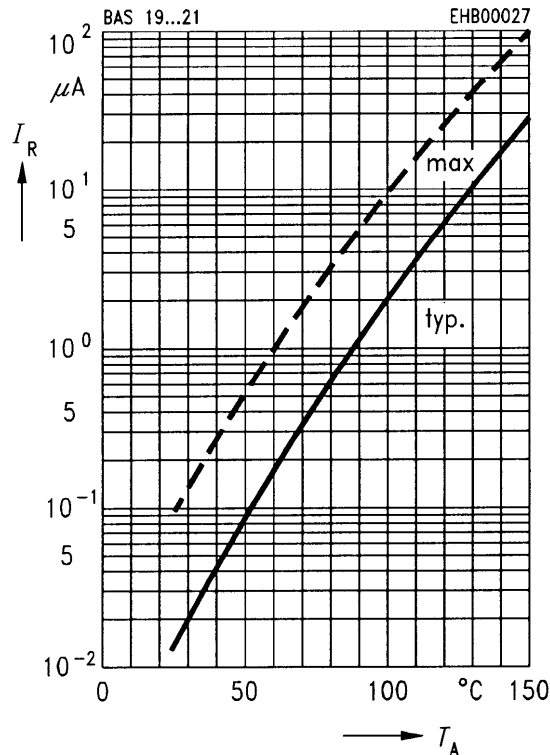

### Forward current $I_F = f(V_F)$

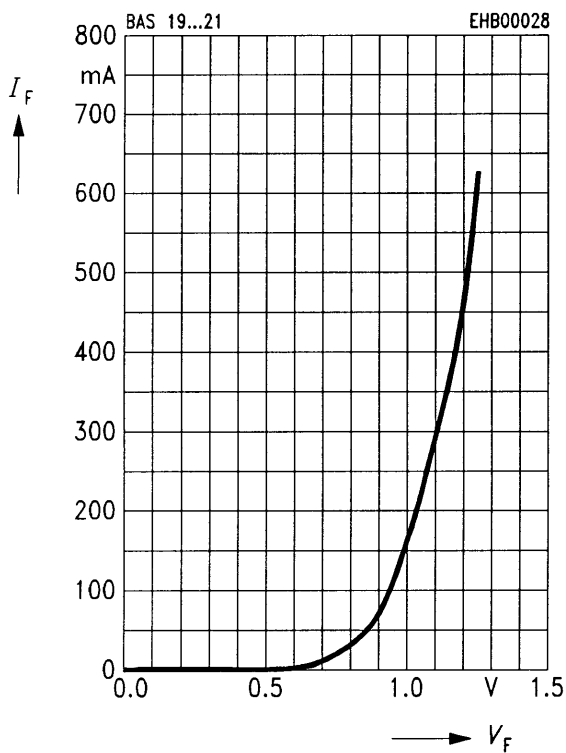

### Forward voltage $V_F = f(T_A)$

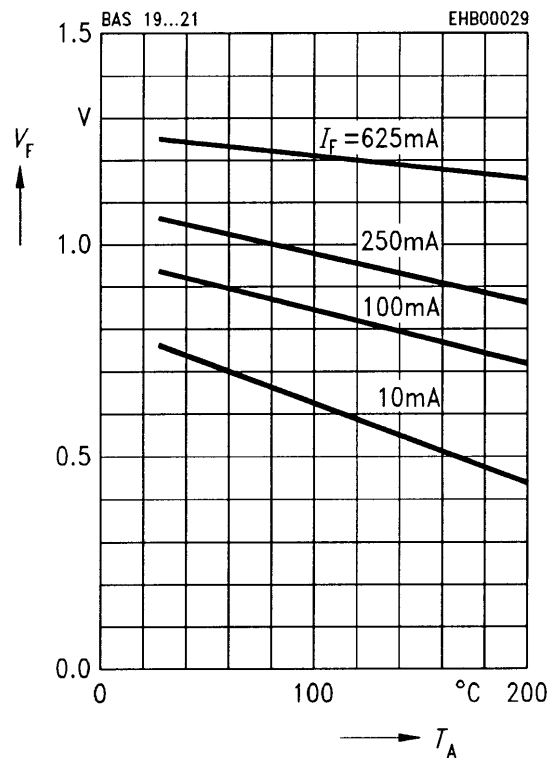

**Reverse voltage  $V_R = f(T_A)$**

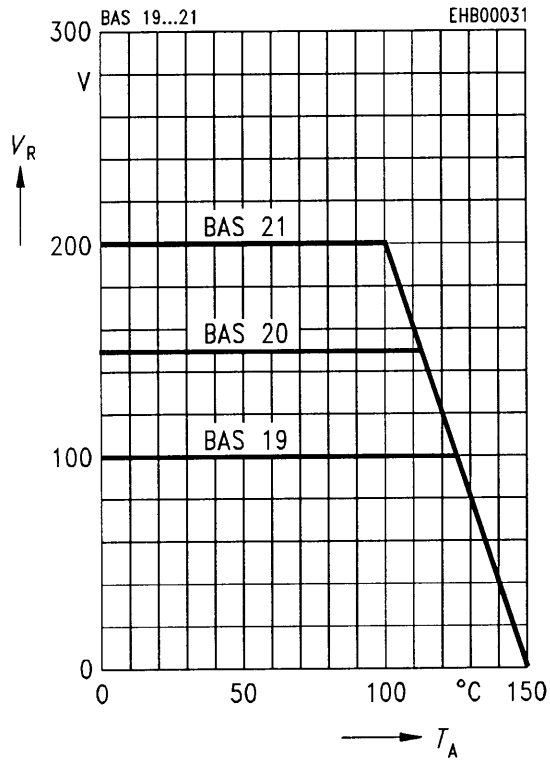

**Peak forward current  $I_{FM} = f(t)$**

