

Silicon Switching Diode Array

- For high speed switching applications
- Common anode

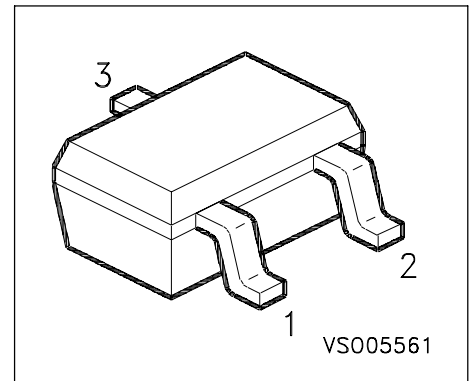
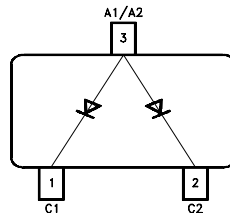

Type	Marking	Ordering Code	Pin Configuration			Package
BAW 56W	A1s	Q62702-A1031	1 = C1	2=C2	3=A1/A2	SOT-323

Maximum Ratings per Diode

Parameter	Symbol	Values	Unit
Diode reverse voltage	V_R	70	V
Peak reverse voltage	V_{RM}	70	
Forward current	I_F	200	mA
Surge forward current, $t = 1 \mu s$	I_{FS}	4.5	A
Total Power dissipation $T_S = 103 \text{ }^\circ\text{C}$	P_{tot}	250	mW
Junction temperature	T_j	150	$^\circ\text{C}$
Storage temperature	T_{stg}	- 65 ... + 150	

Thermal Resistance

Junction ambient ¹⁾	R_{thJA}	≤ 460	K/W
Junction - soldering point	R_{thJS}	≤ 190	

1) Package mounted on epoxy pcb 40mm x 40mm x 1.5mm / 0.5cm² Cu

Electrical Characteristics at $T_A=25^\circ\text{C}$, unless otherwise specified

Parameter	Symbol	Values			Unit
		min.	typ.	max.	

DC characteristics per Diode

Breakdown voltage $I_{(BR)} = 100 \mu\text{A}$	$V_{(BR)}$	70	-	-	V
Forward voltage $I_F = 1 \text{ mA}$	V_F	-	-	715	
$I_F = 10 \text{ mA}$		-	-	855	
$I_F = 50 \text{ mA}$		-	-	1000	
$I_F = 150 \text{ mA}$		-	-	1250	
Reverse current $V_R = 70 \text{ V}, T_A = 25^\circ\text{C}$ $V_R = 25 \text{ V}, T_A = 150^\circ\text{C}$ $V_R = 70 \text{ V}, T_A = 150^\circ\text{C}$	I_R	-	-	2.5 30 50	μA

AC characteristics per Diode

Diode capacitance $V_R = 0 \text{ V}, f = 1 \text{ MHz}$	C_D	-	-	2	pF
Reverse recovery time $I_F = 10 \text{ mA}, I_R = 10 \text{ mA}, R_L = 100 \Omega$ t_{rr} measured at 1 mA	t_{rr}	-	-	6	ns

Forward current $I_F = f(T_A^*; T_S)$

* Package mounted on epoxy

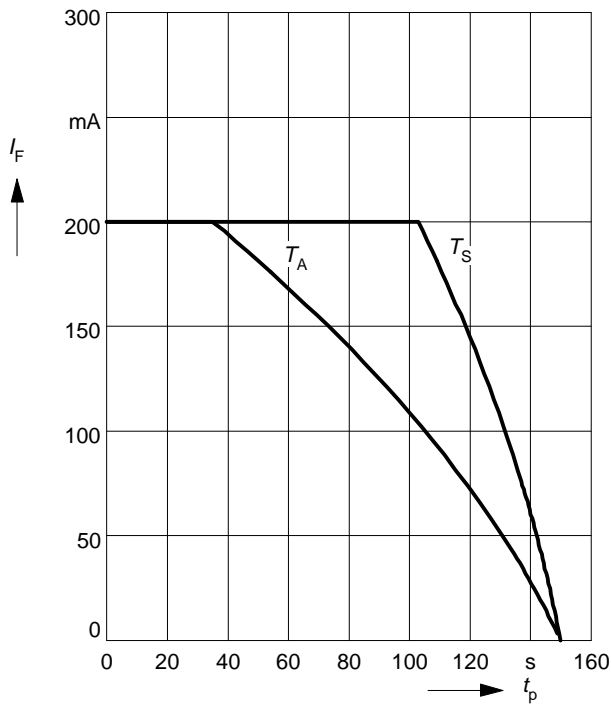

Permissible Pulse Load $R_{thJS} = f(t_p)$

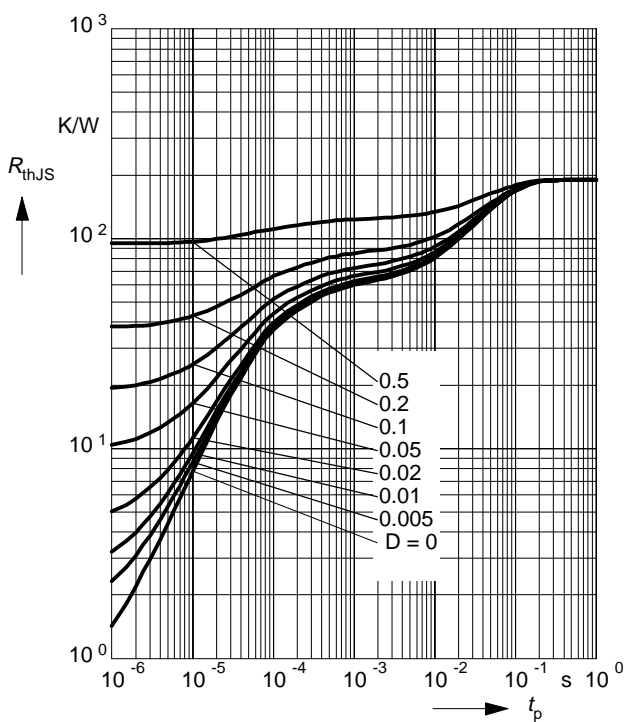

Forward current $I_F = f(V_F)$

$T_A = 25^\circ\text{C}$

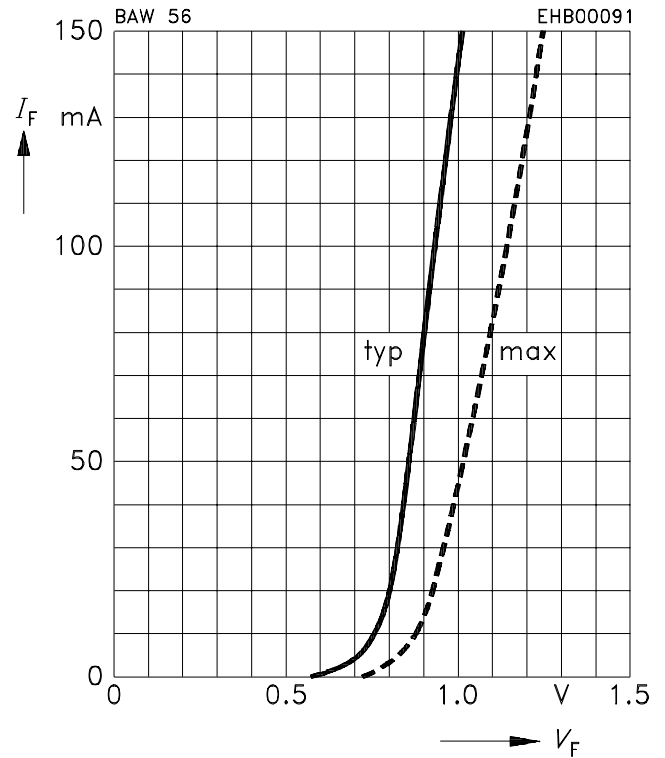

Permissible Pulse Load $I_{Fmax}/I_{FDC} = f(t_p)$

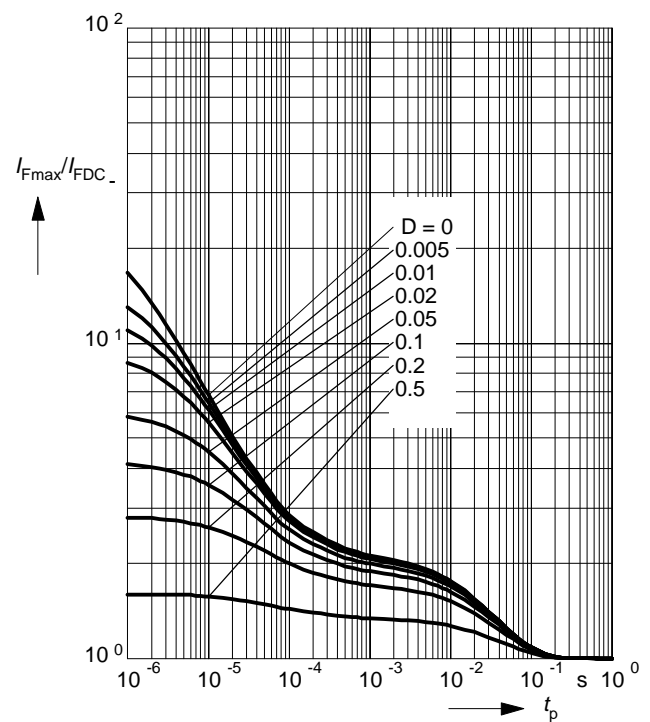

Forward voltage $V_F = f(T_A)$

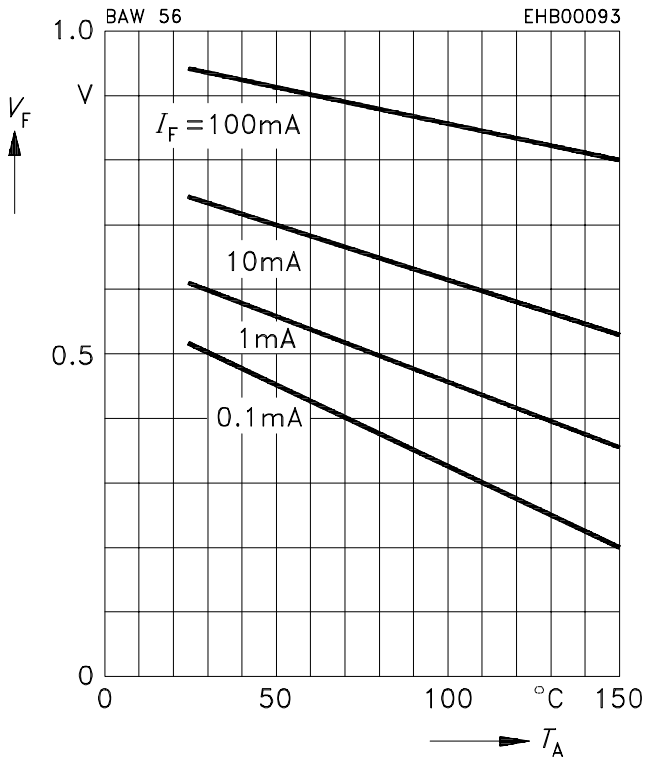

Reverse current $I_R = f(T_A)$

