

## PNP Silicon AF Transistor

BC 369

- High current gain
- High collector current
- Low collector-emitter saturation voltage
- Complementary type: BC 368 (NPN)

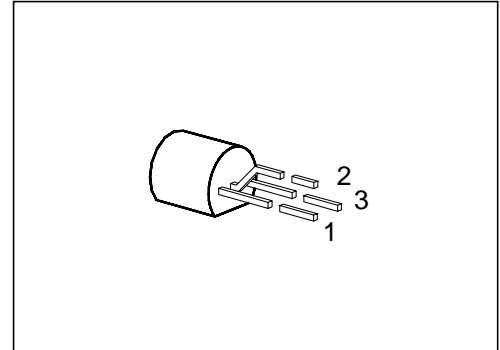

Type	Marking	Ordering Code	Pin Configuration			Package <sup>1)</sup>
			1	2	3	
BC 369	–	C62702-C748	E	C	B	TO-92

### Maximum Ratings

Parameter	Symbol	Values	Unit
Collector-emitter voltage	$V_{CE0}$	20	V
Collector-base voltage	$V_{CB0}$	25	
Emitter-base voltage	$V_{EB0}$	5	
Collector current	$I_C$	1	A
Peak collector current	$I_{CM}$	2	
Base current	$I_B$	100	mA
Peak base current	$I_{BM}$	200	
Total power dissipation, $T_c = 90\text{ °C}^2)$	$P_{tot}$	0.8 (1)	W
Junction temperature	$T_j$	150	°C
Storage temperature range	$T_{stg}$	– 65 ... + 150	

### Thermal Resistance

Junction - ambient <sup>2)</sup>	$R_{th\ JA}$	≤ 156	K/W
Junction - case <sup>3)</sup>	$R_{th\ JC}$	≤ 75	

<sup>1)</sup> For detailed information see chapter Package Outlines.

<sup>2)</sup> If transistors with max. 4 mm lead length are fixed on PCBs with a min. 10 mm × 10 mm large copper area for the collector terminal,  $R_{th\ JA} = 125\text{ K/W}$  and thus  $P_{tot\ max} = 1\text{ W}$  at  $T_A = 25\text{ °C}$ .

<sup>3)</sup> Mounted on Al heat sink 15 mm × 25 mm × 0.5 mm.

**Electrical Characteristics**

at  $T_A = 25\text{ °C}$ , unless otherwise specified.

Parameter	Symbol	Values			Unit
		min.	typ.	max.	

**DC characteristics**

Collector-emitter breakdown voltage $I_C = 30\text{ mA}$	$V_{(BR)CE0}$	20	–	–	V
Collector-base breakdown voltage $I_C = 10\text{ }\mu\text{A}$	$V_{(BR)CB0}$	25	–	–	
Emitter-base breakdown voltage $I_E = 1\text{ }\mu\text{A}$	$V_{(BR)EB0}$	5	–	–	
Collector cutoff current $V_{CB} = 25\text{ V}$ $V_{CB} = 25\text{ V}, T_A = 150\text{ °C}$	$I_{CB0}$	–	–	100 10	nA $\mu\text{A}$
Emitter cutoff current $V_{EB} = 5\text{ V}$	$I_{EB0}$	–	–	100	nA
DC current gain $I_C = 5\text{ mA}; V_{CE} = 10\text{ V}$ $I_C = 500\text{ mA}; V_{CE} = 1\text{ V}^1)$ $I_C = 1\text{ A}; V_{CE} = 1\text{ V}^1)$	$h_{FE}$	50 85 60	– 160 –	– 375 –	–
Collector-emitter saturation voltage <sup>1)</sup> $I_C = 1\text{ A}; I_B = 100\text{ mA}$	$V_{CEsat}$	–	–	0.5	V
Base-emitter voltage <sup>1)</sup> $I_C = 5\text{ mA}; V_{CE} = 10\text{ V}$ $I_C = 1\text{ A}; V_{CE} = 1\text{ V}$	$V_{BE}$	–	0.6 –	– 1	

**AC characteristics**

Transition frequency $I_C = 100\text{ mA}, V_{CE} = 5\text{ V}, f = 20\text{ MHz}$	$f_T$	–	100	–	MHz
---	-------	---	-----	---	-----

<sup>1)</sup> Pulse test:  $t \leq 300\text{ }\mu\text{s}, D \leq 2\text{ %}$ .

**Total power dissipation  $P_{tot} = f(T_A; T_C)$**

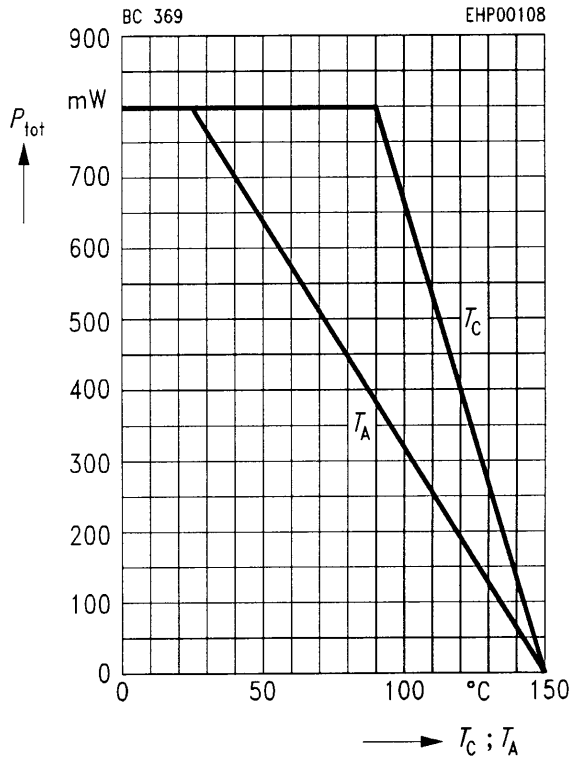

**Collector cutoff current  $I_{CB0} = f(T_A)$   
 $V_{CB} = 25 \text{ V}$**

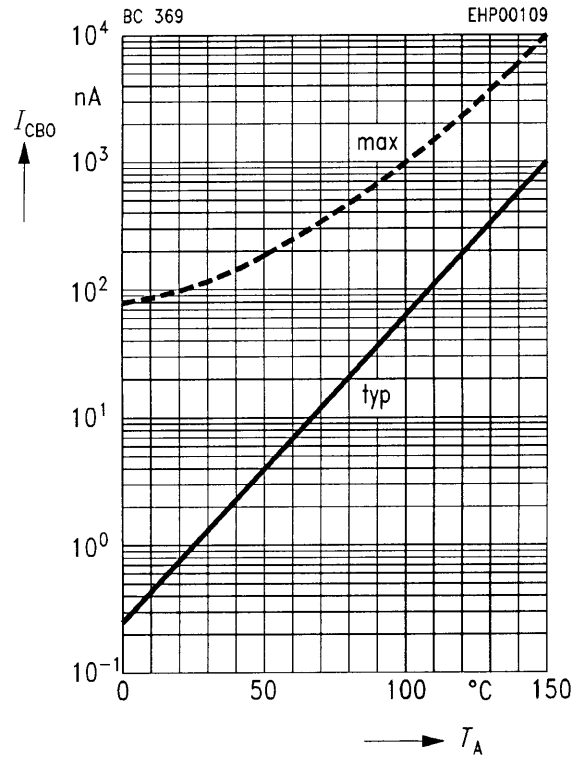

**Permissible pulse load  $R_{thJA} = f(t_p)$**

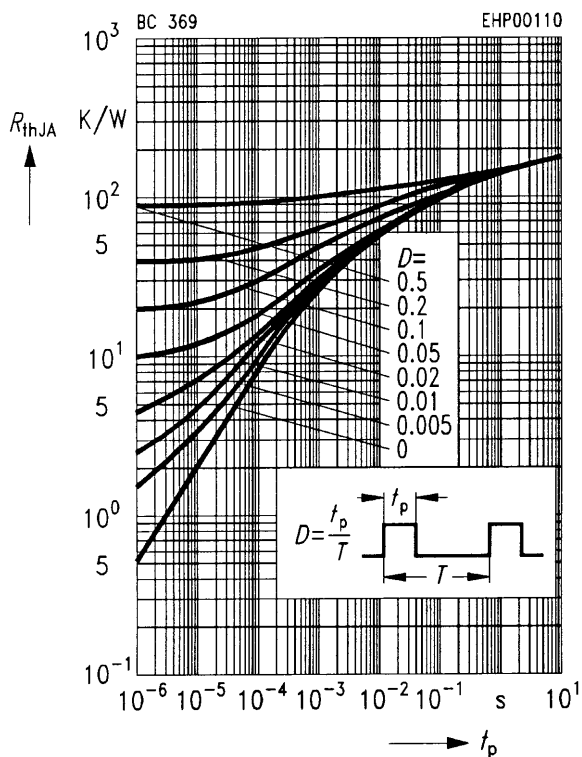

**DC current gain  $h_{FE} = f(I_C)$   
 $V_{CE} = 1 \text{ V}, T_A = 25 \text{ °C}$**

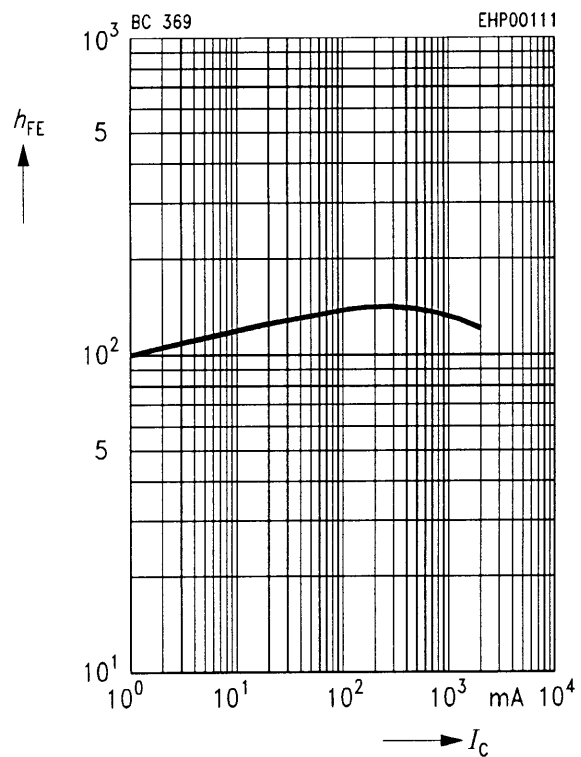

**Collector current  $I_C = f(V_{BE})$**

$V_{CE} = 1 \text{ V}, T_A = 25 \text{ }^\circ\text{C}$

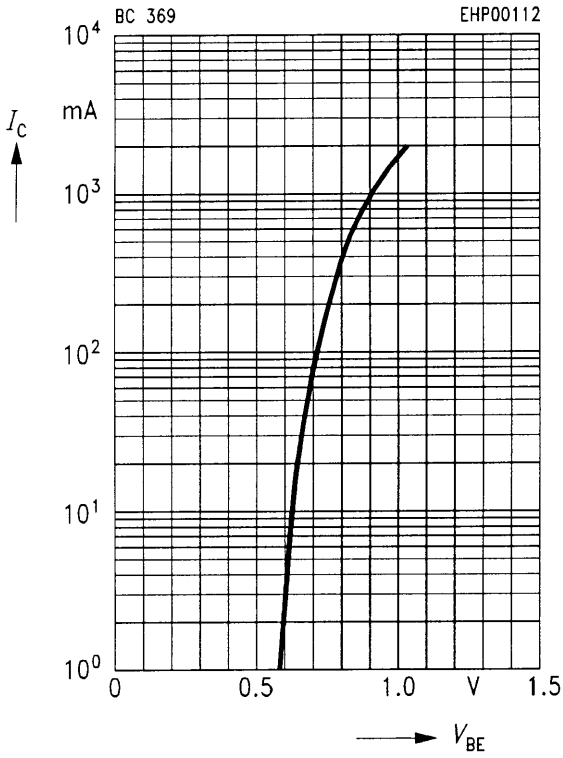

**Collector-emitter saturation voltage  $V_{CEsat} = f(I_C)$**

$h_{FE} = 10, T_A = 25 \text{ }^\circ\text{C}$

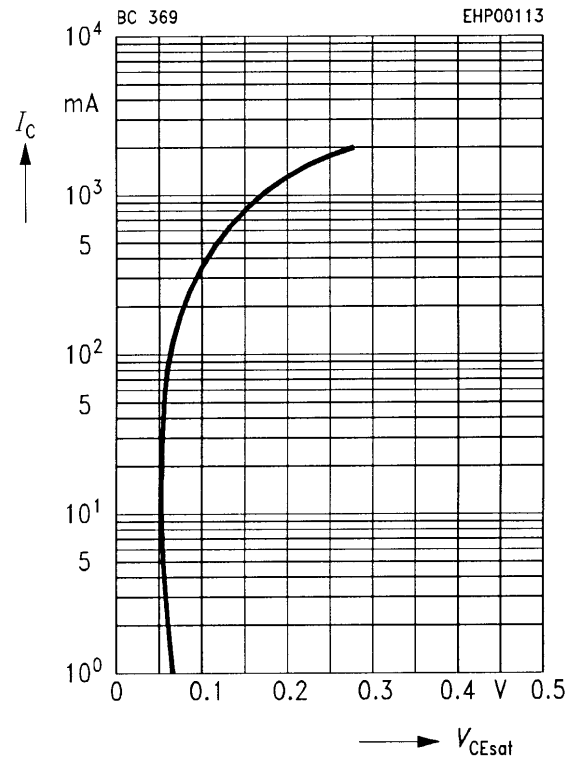

**Transition frequency  $f_T = f(I_C)$**

$V_{CE} = 5 \text{ V}, f = 20 \text{ MHz}$

