

## NPN Silicon Darlington Transistors

**BCP 29**  
**BCP 49**

- For general AF applications
- High collector current
- High current gain
- Complementary types: BCP 28/48 (PNP)

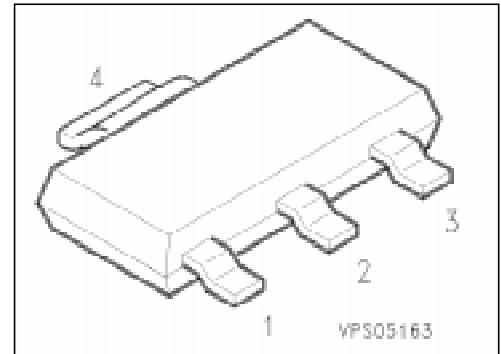

Type	Marking	Ordering Code (tape and reel)	Pin Configuration	Package <sup>1)</sup>
BCP 29 BCP 49	BCP 29 BCP 49	Q62702-C2136 Q62702-C2137		SOT-223

### Maximum Ratings

Parameter	Symbol	Values		Unit
		BCP 29	BCP 49	
Collector-emitter voltage	$V_{CE0}$	30	60	V
Collector-base voltage	$V_{CB0}$	40	80	
Emitter-base voltage	$V_{EB0}$	10	10	
Collector current	$I_C$	500		mA
Peak collector current	$I_{CM}$	800		
Base current	$I_B$	100		
Peak base current	$I_{BM}$	200		
Total power dissipation, $T_S = 124\text{ °C}^2$ )	$P_{tot}$	1.5		W
Junction temperature	$T_j$	150		°C
Storage temperature range	$T_{stg}$	- 65 ... + 150		

### Thermal Resistance

Junction - ambient <sup>2)</sup>	$R_{th\ JA}$	$\leq 75$	K/W
Junction - soldering point	$R_{th\ JS}$	$\leq 17$	

<sup>1)</sup> For detailed information see chapter Package Outlines.

<sup>2)</sup> Package mounted on epoxy pcb 40 mm × 40 mm × 1.5 mm/6 cm<sup>2</sup> Cu.

## Electrical Characteristics

at  $T_A = 25\text{ °C}$ , unless otherwise specified.

Parameter	Symbol	Values			Unit
		min.	typ.	max.	

### DC characteristics

Collector-emitter breakdown voltage $I_C = 1\text{ mA}, I_B = 0$	$V_{(BR)CE0}$				V
BCP 29	30	–	–		
BCP 49	60	–	–		
Collector-base breakdown voltage $I_C = 100\text{ }\mu\text{A}, I_B = 0$	$V_{(BR)CB0}$				
BCP 29	40	–	–		
BCP 49	80	–	–		
Emitter-base breakdown voltage $I_E = 10\text{ }\mu\text{A}, I_C = 0$	$V_{(BR)EB0}$	10	–	–	
Collector-base cutoff current $V_{CB} = 30\text{ V}, I_E = 0$	$I_{CB0}$	–	–	100	nA
$V_{CB} = 60\text{ V}, I_E = 0$	BCP 49	–	–	100	nA
$V_{CB} = 30\text{ V}, I_E = 0, T_A = 150\text{ °C}$	BCP 29	–	–	10	$\mu\text{A}$
$V_{CB} = 60\text{ V}, I_E = 0, T_A = 150\text{ °C}$	BCP 49	–	–	10	$\mu\text{A}$
Emitter-base cutoff current $V_{EB} = 4\text{ V}, I_C = 0$	$I_{EB0}$	–	–	100	nA
DC current gain <sup>1)</sup> $I_C = 100\text{ }\mu\text{A}, V_{CE} = 1\text{ V}$	$h_{FE}$	4000	–	–	–
BCP 49	2000	–	–		
$I_C = 10\text{ mA}, V_{CE} = 5\text{ V}$	BCP 29	10000	–	–	
BCP 49	4000	–	–		
$I_C = 100\text{ mA}, V_{CE} = 5\text{ V}$	BCP 29	20000	–	–	
BCP 49	10000	–	–		
$I_C = 500\text{ mA}, V_{CE} = 5\text{ V}$	BCP 29	4000	–	–	
BCP 49	2000	–	–		
Collector-emitter saturation voltage $I_C = 100\text{ mA}, I_B = 0.1\text{ mA}$	$V_{CEsat}$	–	–	1.0	V
Base-emitter saturation voltage $I_C = 100\text{ mA}, I_B = 0.1\text{ mA}$	$V_{BEsat}$	–	–	1.5	

<sup>1)</sup> Pulse test conditions:  $t \leq 300\text{ }\mu\text{s}, D = 2\%$ .

## Electrical Characteristics

at  $T_A = 25\text{ °C}$ , unless otherwise specified.

Parameter	Symbol	Values			Unit
		min.	typ.	max.	

### AC characteristics

Transition frequency $I_C = 50\text{ mA}$ , $V_{CE} = 5\text{ V}$ , $f = 100\text{ MHz}$	$f_t$	–	200	–	MHz
Output capacitance $V_{CB} = 10\text{ V}$ , $f = 1\text{ MHz}$	$C_{obo}$	–	6.5	–	pF

**Total power dissipation  $P_{tot} = f(T_A^*; T_S)$**

\* Package mounted on epoxy

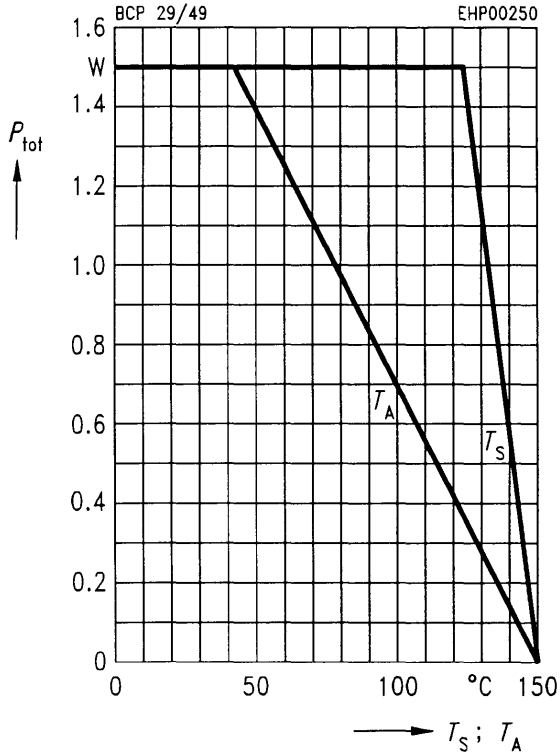

**Collector cutoff current  $I_{CB0} = f(T_A)$**

$V_{CB} = V_{CE\ max}$

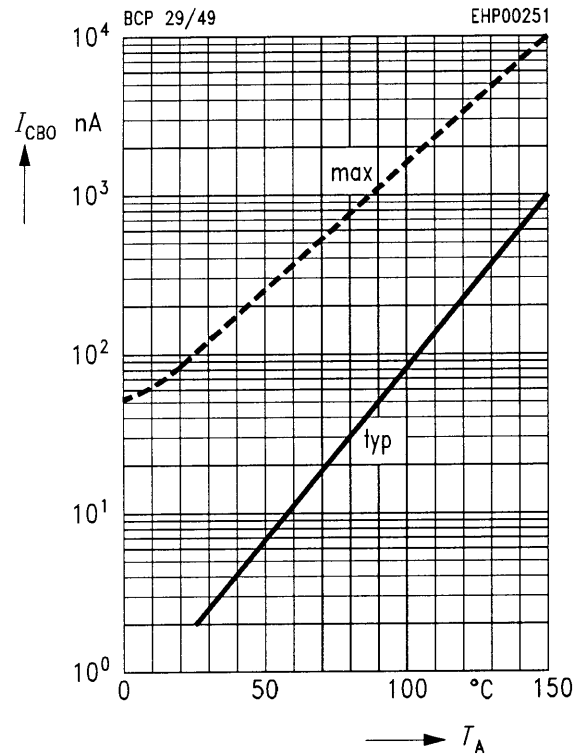

**Transition frequency  $f_T = f(I_C)$**

$V_{CE} = 5\ V$

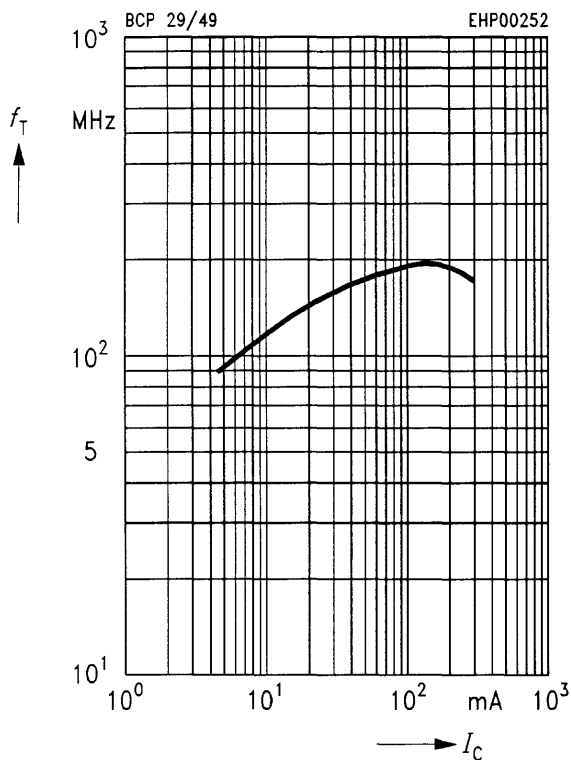

**Permissible pulse load  $P_{tot\ max}/P_{tot\ DC} = f(t_p)$**

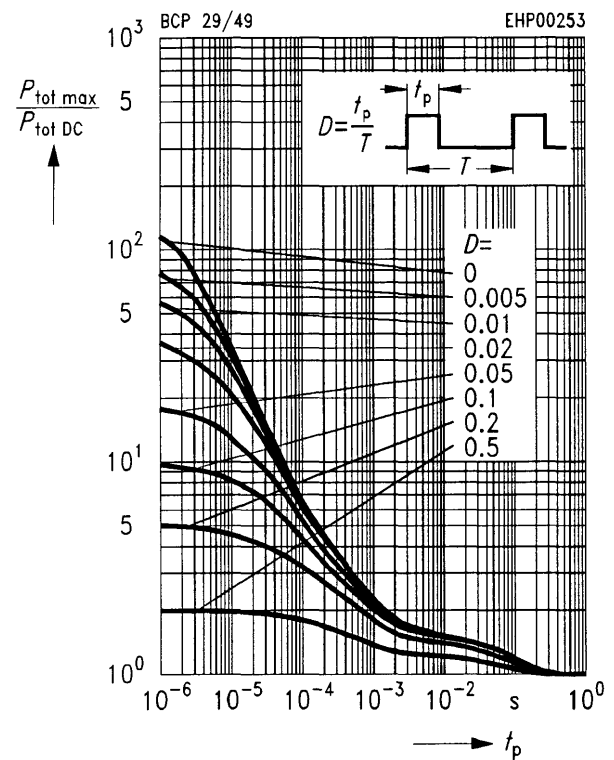

**DC current gain  $h_{FE} = f(I_C)$**

$V_{CE} = 10\text{ V}$

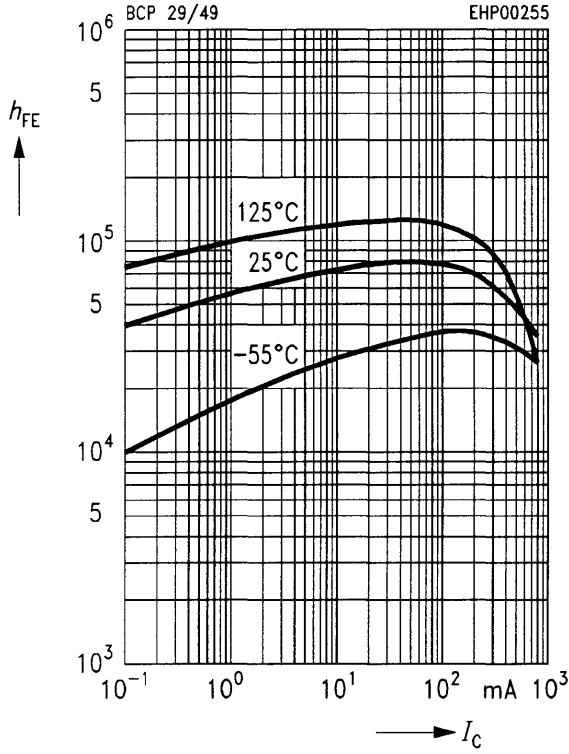

**Collector-emitter saturation voltage**

$I_C = f(V_{CEsat})$

$h_{FE} = 1000$

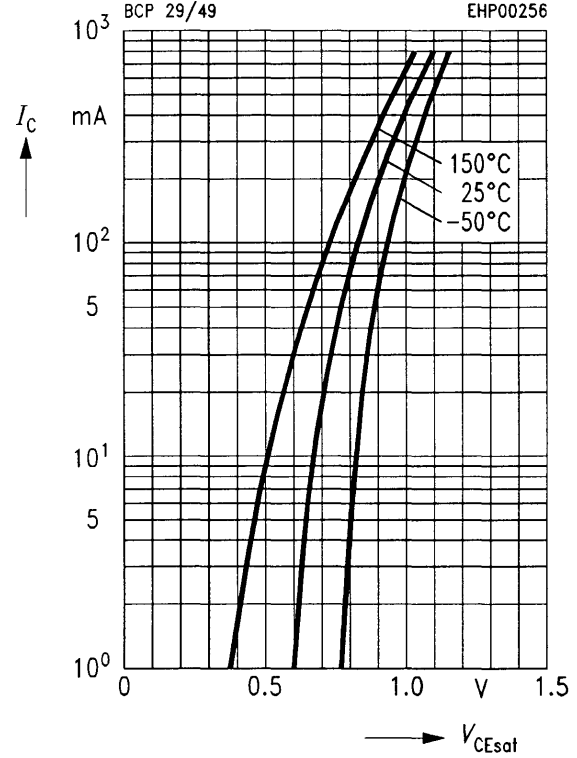

**Collector-base capacitance  $C_{CB0} = f(V_{CB0})$**

**Emitter-base capacitance  $C_{EB0} = f(V_{EB0})$**

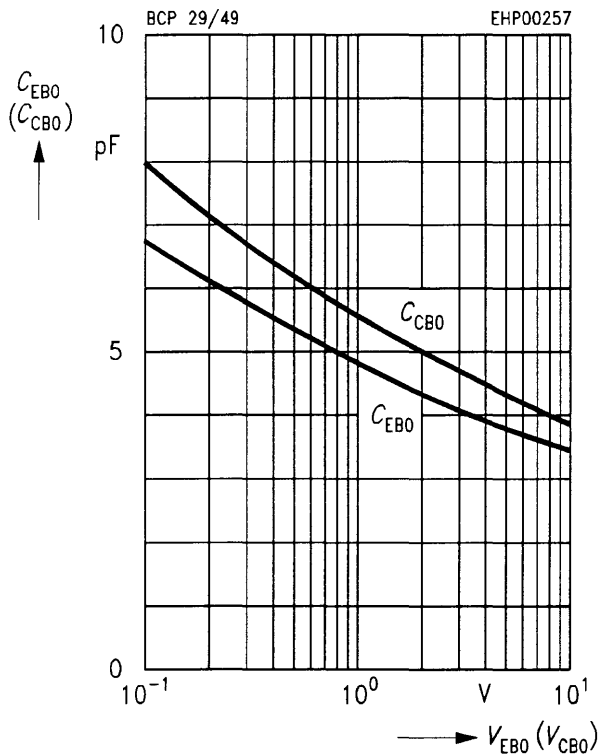

**Base-emitter saturation voltage**

$I_C = f(V_{BEsat})$

$h_{FE} = 1000$

