

## PNP Silicon AF Transistors

**BCP 51**  
**... BCP 53**

- For AF driver and output stages
- High collector current
- Low collector-emitter saturation voltage
- Complementary types: BCP 54 ... BCP 56 (NPN)

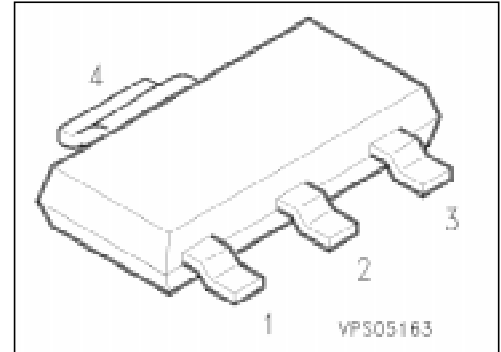

Type	Marking	Ordering Code (tape and reel)	Pin Configuration				Package <sup>1)</sup>
			1	2	3	4	
BCP 51	BCP 51	Q62702-C2107	B	C	E	C	SOT-223
BCP 51-10	BCP 51-10	Q62702-C2109					
BCP 51-16	BCP 51-16	Q62702-C2110					
BCP 52	BCP 52	Q62702-C2146					
BCP 52-10	BCP 52-10	Q62702-C2112					
BCP 52-16	BCP 52-16	Q62702-C2113					
BCP 53	BCP 53	Q62702-C2147					
BCP 53-10	BCP 53-10	Q62702-C2115					
BCP 53-16	BCP 53-16	Q62702-C2116					

<sup>1)</sup> For detailed information see chapter Package Outlines.

## Maximum Ratings

Parameter	Symbol	Values			Unit
		BCP 51	BCP 52	BCP 53	
Collector-emitter voltage $R_{BE} \leq 1 \text{ k}\Omega$	$V_{CE0}$	45	60	80	V
	$V_{CER}$	45	60	100	
Collector-base voltage	$V_{CB0}$	45	60	100	
Emitter-base voltage	$V_{EB0}$	5			
Collector current	$I_C$	1			A
Peak collector current	$I_{CM}$	1.5			
Base current	$I_B$	100			mA
Peak base current	$I_{BM}$	200			
Total power dissipation, $T_s = 124 \text{ }^\circ\text{C}^1)$	$P_{tot}$	1.5			W
Junction temperature	$T_j$	150			$^\circ\text{C}$
Storage temperature range	$T_{stg}$	- 65 ... + 150			

## Thermal Resistance

Junction - ambient <sup>1)</sup>	$R_{th JA}$	$\leq 72$	K/W
Junction - soldering point	$R_{th JS}$	$\leq 17$	

<sup>1)</sup> Package mounted on epoxy pcb 40 mm × 40 mm × 1.5 mm/6 cm<sup>2</sup> Cu.

## Electrical Characteristics

at  $T_A = 25\text{ °C}$ , unless otherwise specified.

Parameter	Symbol	Values			Unit
		min.	typ.	max.	

### DC characteristics

Collector-emitter breakdown voltage $I_C = 10\text{ mA}$ , $I_B = 0$	$V_{(BR)CE0}$	BCP 51	45	–	–	V
BCP 52		60	–	–		
BCP 53		80	–	–		
Collector-base breakdown voltage $I_C = 100\text{ }\mu\text{A}$ , $I_B = 0$	$V_{(BR)CB0}$	BCP 51	45	–	–	
BCP 52		60	–	–		
BCP 53		100	–	–		
Emitter-base breakdown voltage $I_E = 10\text{ }\mu\text{A}$ , $I_C = 0$	$V_{(BR)EB0}$		5	–	–	
Collector-base cutoff current $V_{CB} = 30\text{ V}$ , $I_E = 0$ $V_{CB} = 30\text{ V}$ , $I_E = 0$ , $T_A = 150\text{ °C}$	$I_{CB0}$		–	–	100	nA
				–	–	20
Emitter-base cutoff current $V_{EB} = 5\text{ V}$ , $I_C = 0$	$I_{EB0}$		–	–	10	$\mu\text{A}$
DC current gain <sup>1)</sup> $I_C = 5\text{ mA}$ , $V_{CE} = 2\text{ V}$ $I_C = 150\text{ mA}$ , $V_{CE} = 2\text{ V}$	$h_{FE}$	BCP 51/BCP 52/BCP 53	25	–	–	–
BCP 51/BCP 52/BCP 53-10		40	–	250		
BCP 51/BCP 52/BCP 53-16		63	100	160		
$I_C = 500\text{ mA}$ , $V_{CE} = 2\text{ V}$		100	160	250		
Collector-emitter saturation voltage <sup>1)</sup> $I_C = 500\text{ mA}$ , $I_B = 50\text{ mA}$	$V_{CEsat}$		–	–	0.5	V
Base-emitter voltage <sup>1)</sup> $I_C = 500\text{ mA}$ , $V_{CE} = 2\text{ V}$	$V_{BE}$		–	–	1	

### AC characteristics

Transition frequency $I_C = 50\text{ mA}$ , $V_{CE} = 10\text{ V}$ , $f = 100\text{ MHz}$	$f_T$	–	125	–	MHz
--	-------	---	-----	---	-----

<sup>1)</sup> Pulse test conditions:  $t \leq 300\text{ }\mu\text{s}$ ,  $D = 2\%$ .

### Total power dissipation $P_{tot} = f(T_A^*; T_S)$

\* Package mounted on epoxy

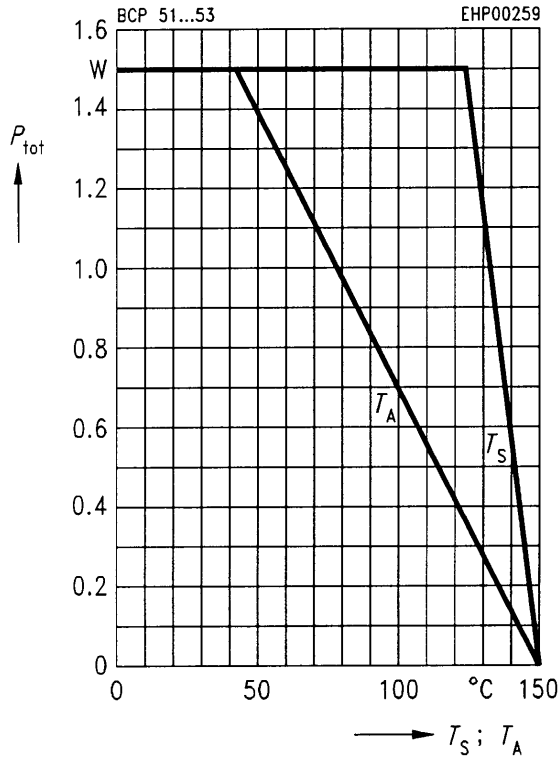

### Transition frequency $f_T = f(I_C)$

$V_{CE} = 10\text{ V}$

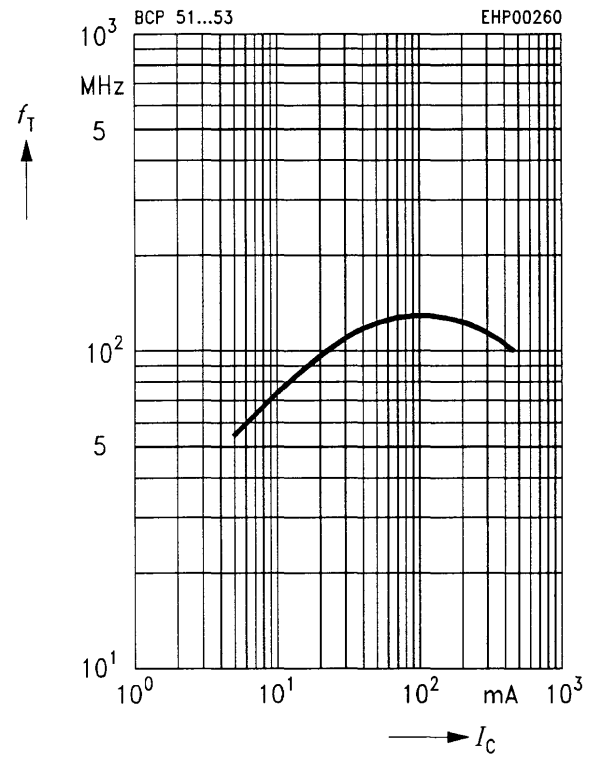

### DC current gain $h_{FE} = f(I_C)$

$V_{CE} = 2\text{ V}$

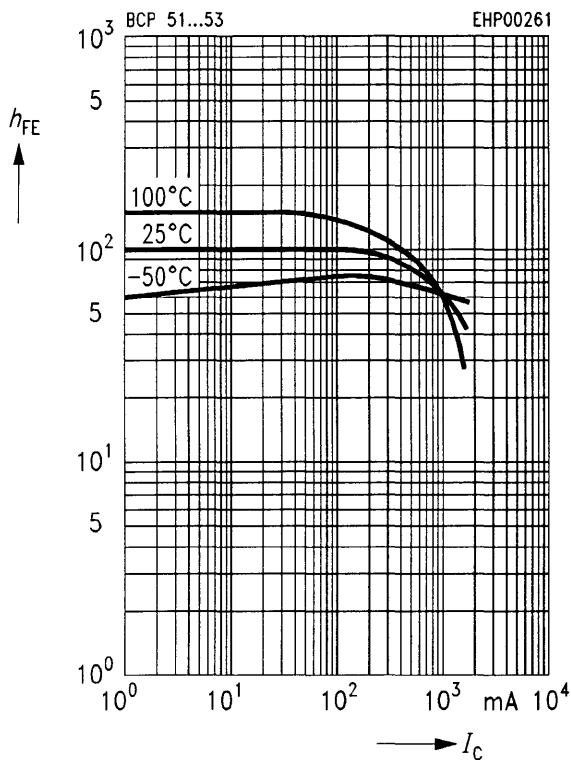

### Collector cutoff current $I_{CBO} = f(T_A)$

$V_{CB} = 30\text{ V}$

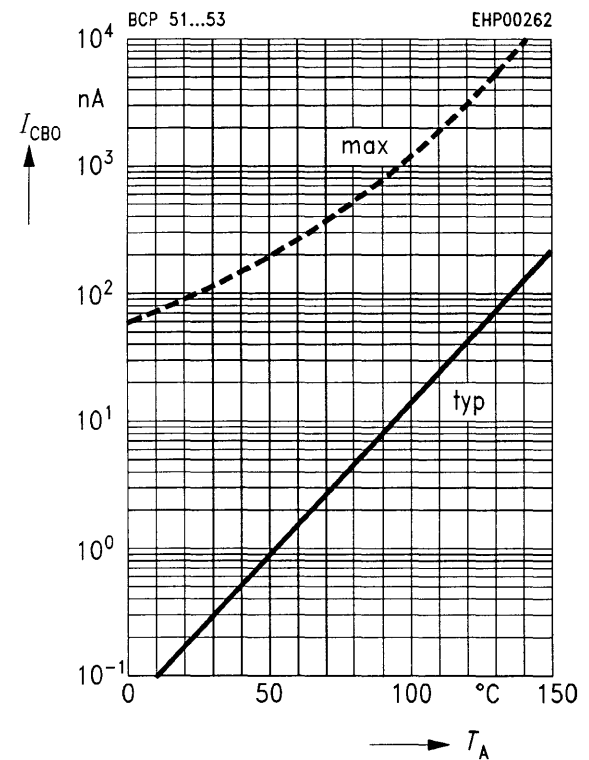

**Base-emitter saturation voltage**

$I_C = f(V_{BEsat})$

$h_{FE} = 10$

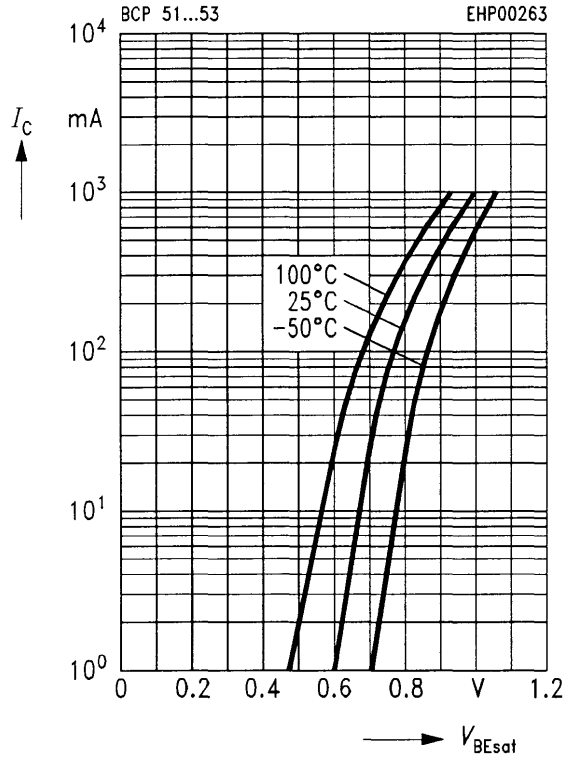

**Collector-emitter saturation voltage**

$I_C = f(V_{CEsat})$

$h_{FE} = 10$

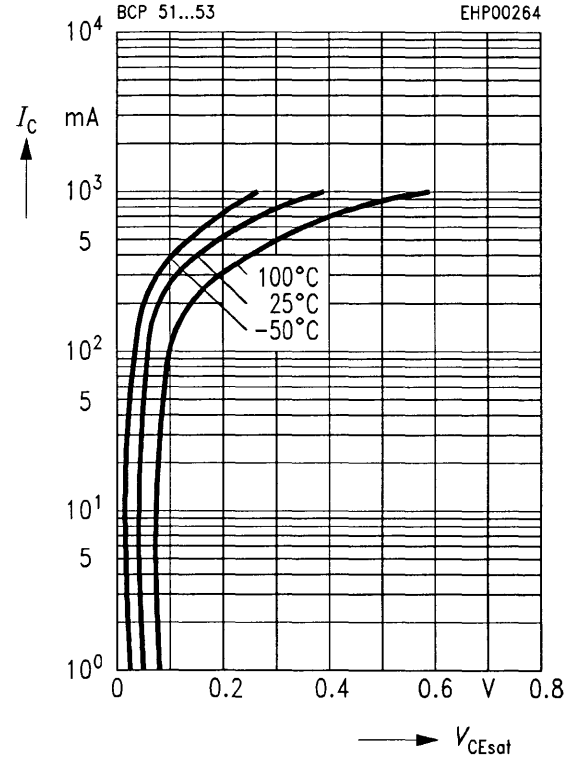

**Permissible pulse load  $P_{tot max}/P_{tot DC} = f(t_p)$**

