

## NPN Silicon AF Switching Transistor

BCX 12

- For general AF applications
- High breakdown voltage
- Low collector-emitter saturation voltage
- Complementary type: BCX 13 (PNP)

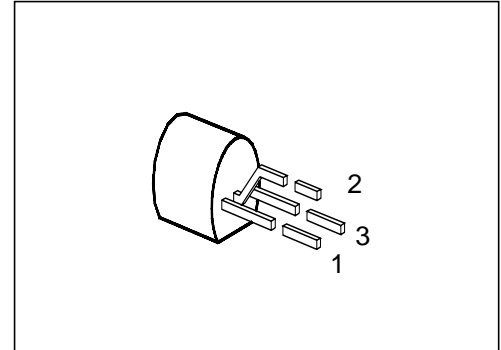

Type	Marking	Ordering Code	Pin Configuration			Package <sup>1)</sup>
			1	2	3	
BCX 12	BCX 12	Q62702-C25	C	B	E	TO-92

### Maximum Ratings

Parameter	Symbol	Values	Unit
Collector-emitter voltage	$V_{CE0}$	125	V
Collector-base voltage	$V_{CB0}$	125	
Emitter-base voltage	$V_{EB0}$	5	
Collector current	$I_C$	800	mA
Peak collector current	$I_{CM}$	1	A
Base current	$I_B$	100	mA
Peak base current	$I_{BM}$	200	
Total power dissipation, $T_c = 66\text{ °C}$	$P_{tot}$	625	mW
Junction temperature	$T_j$	150	°C
Storage temperature range	$T_{stg}$	- 65 ... + 150	

### Thermal Resistance

Junction - ambient	$R_{th\ JA}$	≤ 200	K/W
Junction - case <sup>2)</sup>	$R_{th\ JC}$	≤ 135	

<sup>1)</sup> For detailed information see chapter Package Outlines.

<sup>2)</sup> Mounted on Al heat sink 15 mm × 25 mm × 0.5 mm.

## Electrical Characteristics

at  $T_A = 25\text{ °C}$ , unless otherwise specified.

Parameter	Symbol	Values			Unit
		min.	typ.	max.	

### DC characteristics

Collector-emitter breakdown voltage $I_C = 10\text{ mA}$ , $I_B = 0$	$V_{(BR)CE0}$	125	–	–	V
Collector-base breakdown voltage $I_C = 100\text{ }\mu\text{A}$ , $I_B = 0$	$V_{(BR)CB0}$	125	–	–	
Emitter-base breakdown voltage $I_E = 10\text{ }\mu\text{A}$ , $I_C = 0$	$V_{(BR)EBS}$	5	–	–	
Collector-base cutoff current $V_{CB} = 100\text{ V}$ , $I_E = 0$ $V_{CB} = 100\text{ V}$ , $I_E = 0$ , $T_A = 150\text{ °C}$	$I_{CB0}$	–	–	100 10	nA $\mu\text{A}$
Emitter cutoff current $V_{EB} = 4\text{ V}$	$I_{EB0}$	–	–	100	nA
DC current gain <sup>1)</sup> $I_C = 1\text{ mA}$ , $V_{CE} = 1\text{ V}$ $I_C = 10\text{ mA}$ , $V_{CE} = 1\text{ V}$ $I_C = 100\text{ mA}$ , $V_{CE} = 1\text{ V}$ $I_C = 200\text{ mA}$ , $V_{CE} = 1\text{ V}$	$h_{FE}$	25 50 63 40	– – – –	– – – –	–
Collector-emitter saturation voltage <sup>1)</sup> $I_C = 500\text{ mA}$ , $I_B = 50\text{ mA}$	$V_{CEsat}$	–	–	1.0	V
Base-emitter saturation voltage <sup>1)</sup> $I_C = 500\text{ mA}$ , $I_B = 50\text{ mA}$	$V_{BEsat}$	–	–	1.6	

### AC characteristics

Transition frequency $I_C = 20\text{ mA}$ , $V_{CE} = 5\text{ V}$ , $f = 20\text{ MHz}$	$f_T$	–	100	–	MHz
Output capacitance $V_{CB} = 10\text{ V}$ , $f = 1\text{ MHz}$	$C_{obo}$	–	10	–	pF

<sup>1)</sup> Pulse test:  $t \leq 300\text{ }\mu\text{s}$ ,  $D \leq 2\%$ .

Total power dissipation  $P_{tot} = f(T_A; T_C)$

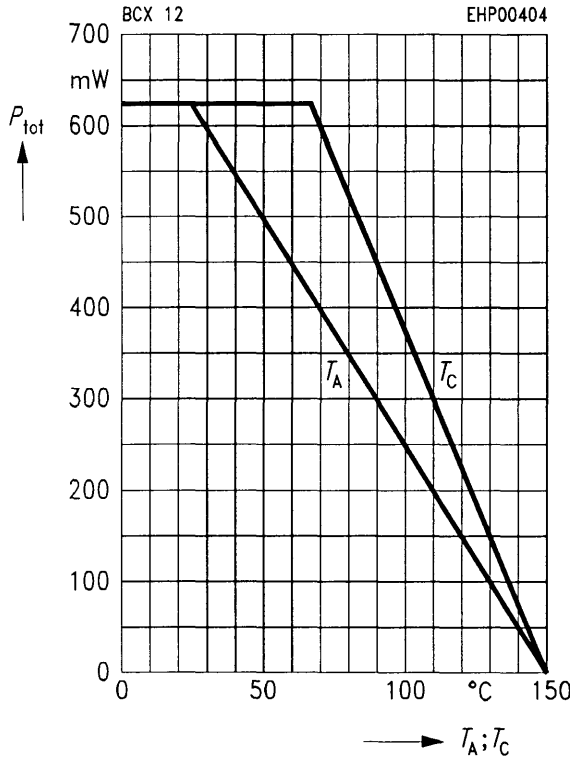

Permissible pulse load  $R_{thJA} = f(t_p)$

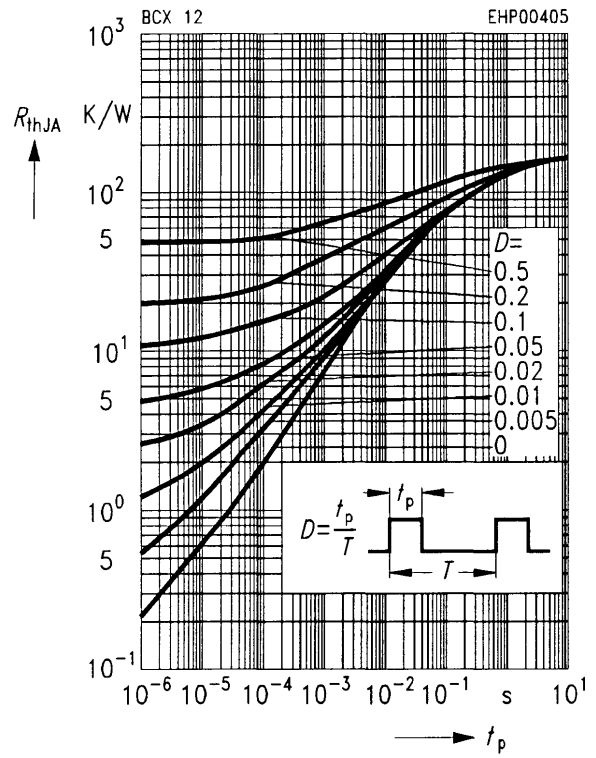

Collector current  $I_C = f(V_{BE})$   
 $V_C = 1 V$

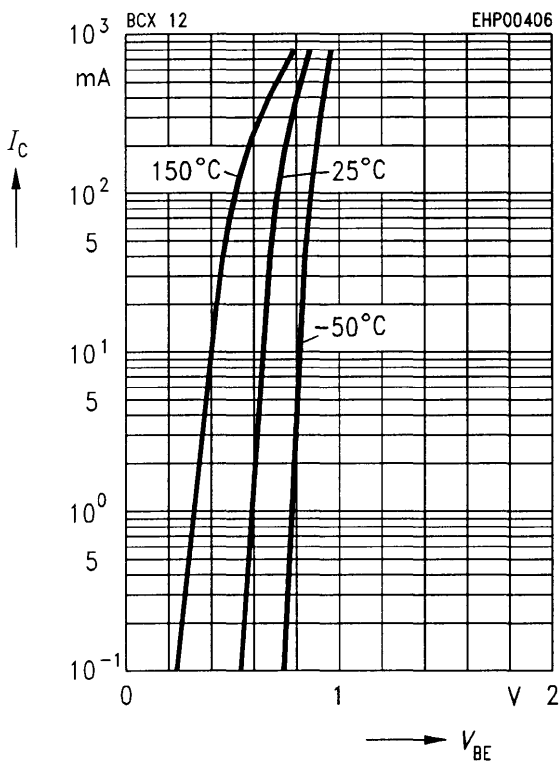

Collector cutoff current  $I_{CB0} = f(T_A)$   
 $V_{CB} = V_{CBmax}$

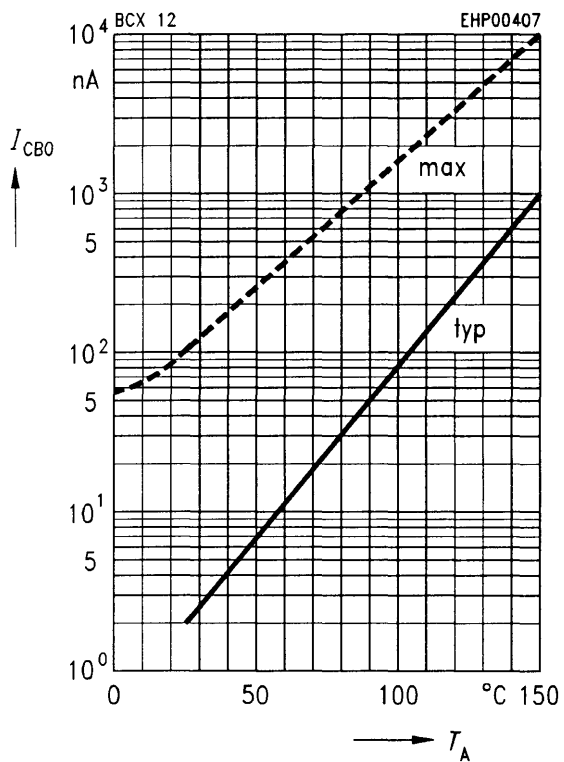

**DC current gain  $h_{FE} = f(I_C)$**

$V_{CE} = 1 \text{ V}$

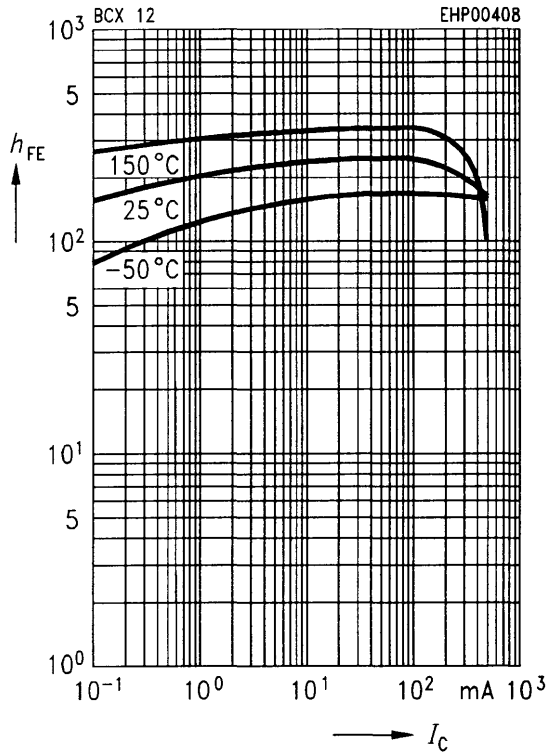

**Transition frequency  $f_T = f(I_C)$**

$f = 20 \text{ MHz}, V_{CE} = 5 \text{ V}, T_A = 25^\circ \text{C}$

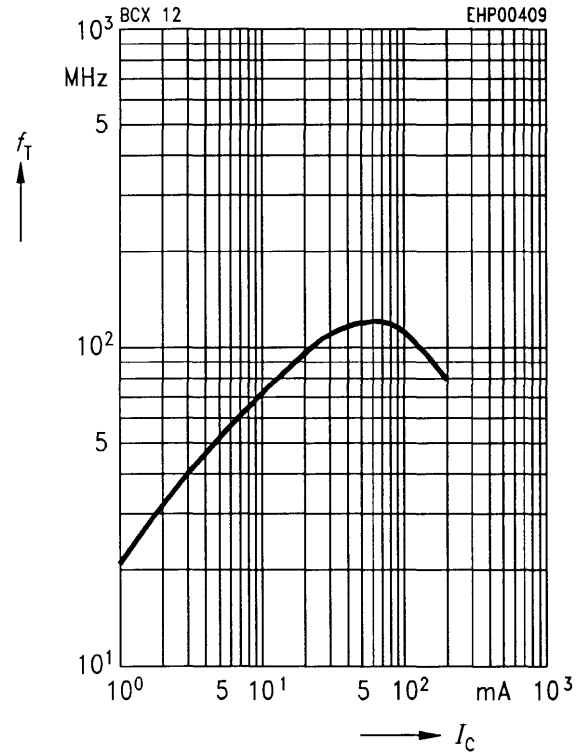

**Collector-emitter saturation voltage**

$I_C = f(V_{CEsat}), h_{FE} = 10$

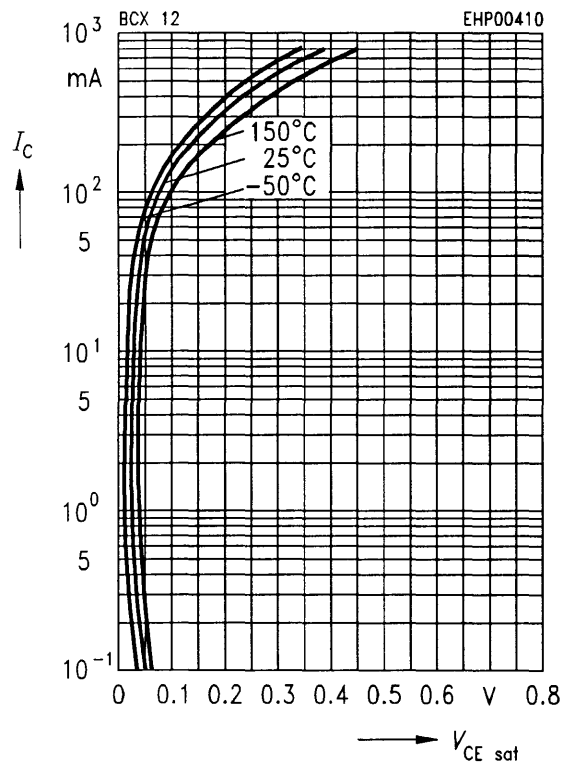

**Base-emitter saturation voltage**

$I_C = f(V_{BEsat}), h_{FE} = 10$

