

Silicon N-Channel MOSFET Tetrode

- For low noise, high gain controlled input stages up to 1GHz
- Operating voltage 9V
- Integrated bias network

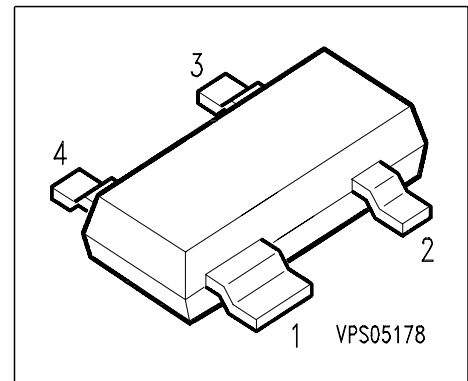
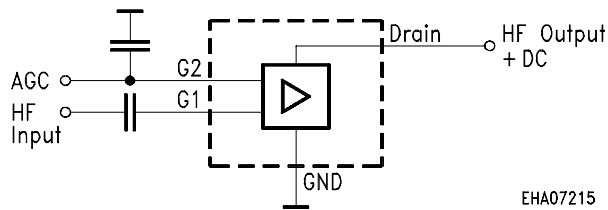

ESD: Electrostatic discharge sensitive device, observe handling precaution!

Type	Marking	Ordering Code	Pin Configuration				Package
BF 1009S	JLs	Q62702-F1628	1 = S	2 = D	3 = G2	4 = G1	SOT-143

Maximum Ratings

Parameter	Symbol	Value	Unit
Drain-source voltage	V_{DS}	12	V
Continuous drain current	I_D	25	mA
Gate 1/gate 2 peak source current	$\pm I_{G1/2SM}$	10	
Gate 1 (external biasing)	$+V_{G1SE}$	3	V
Total power dissipation, $T_S \leq 76^\circ\text{C}$	P_{tot}	200	mW
Storage temperature	T_{stg}	-55 ... +150	°C
Channel temperature	T_{ch}	150	

Thermal Resistance

Channel - soldering point	R_{thchs}	≤ 370	K/W
---------------------------	-------------	------------	-----

Note:

It is not recommended to apply external DC-voltage on Gate 1 in active mode.

Electrical Characteristics at $T_A = 25^\circ\text{C}$, unless otherwise specified.

Parameter	Symbol	Values			Unit
		min.	typ.	max.	
DC characteristics					
Drain-source breakdown voltage $I_D = 300 \mu\text{A}$, $-V_{G1S} = 4 \text{ V}$, $-V_{G2S} = 4 \text{ V}$	$V_{(BR)DS}$	16	-	-	V
Gate 1 source breakdown voltage $\pm I_{G1S} = 10 \text{ mA}$, $V_{G2S} = V_{DS} = 0$	$\pm V_{(BR)G1SS}$	8	-	12	
Gate 2 source breakdown voltage $\pm I_{G2S} = 10 \text{ mA}$, $V_{G1S} = 0 \text{ V}$, $V_{DS} = 0 \text{ V}$	$\pm V_{(BR)G2SS}$	10	-	16	
Gate 1 source current $V_{G1S} = 6 \text{ V}$, $V_{G2S} = 0 \text{ V}$	$+I_{G1SS}$	-	-	60	μA
Gate 2 source leakage current $\pm V_{G2S} = 8 \text{ V}$, $V_{G1S} = 0 \text{ V}$, $V_{DS} = 0 \text{ V}$	$\pm I_{G2SS}$	-	-	50	nA
Drain current $V_{DS} = 9 \text{ V}$, $V_{G1S} = 0$, $V_{G2S} = 6 \text{ V}$	I_{DSS}	-	-	500	μA
Operating current (selfbiased) $V_{DS} = 9 \text{ V}$, $V_{G2S} = 6 \text{ V}$	I_{DSO}	10	14	19	mA
Gate 2-source pinch-off voltage $V_{DS} = 9 \text{ V}$, $I_D = 100 \mu\text{A}$	$V_{G2S(p)}$	-	0.9	-	V
AC characteristics					
Forward transconductance (self biased) $V_{DS} = 9 \text{ V}$, $V_{G2S} = 6 \text{ V}$, $f = 1 \text{ kHz}$	g_{fs}	26	30	-	mS
Gate 1-input capacitance (self biased) $V_{DS} = 9 \text{ V}$, $V_{G2S} = 6 \text{ V}$, $f = 1 \text{ MHz}$	C_{g1ss}	-	2.1	2.7	pF
Output capacitance (self biased) $V_{DS} = 9 \text{ V}$, $V_{G2S} = 6 \text{ V}$, $f = 100 \text{ MHz}$	C_{dss}	-	0.9	-	
Power gain (self biased) $V_{DS} = 9 \text{ V}$, $V_{G2S} = 6 \text{ V}$, $f = 800 \text{ MHz}$	G_{ps}	18	22	-	dB
Noise figure (self biased) $V_{DS} = 9 \text{ V}$, $V_{G2S} = 6 \text{ V}$, $f = 800 \text{ MHz}$	F_{800}	-	1.4	-	
Gain control range (self biased) $V_{DS} = 9 \text{ V}$, $V_{G2S} = 1 \text{ V}$, $f = 800 \text{ MHz}$	ΔG_{ps}	40	50	-	

Total power dissipation $P_{\text{tot}} = f(T_S)$

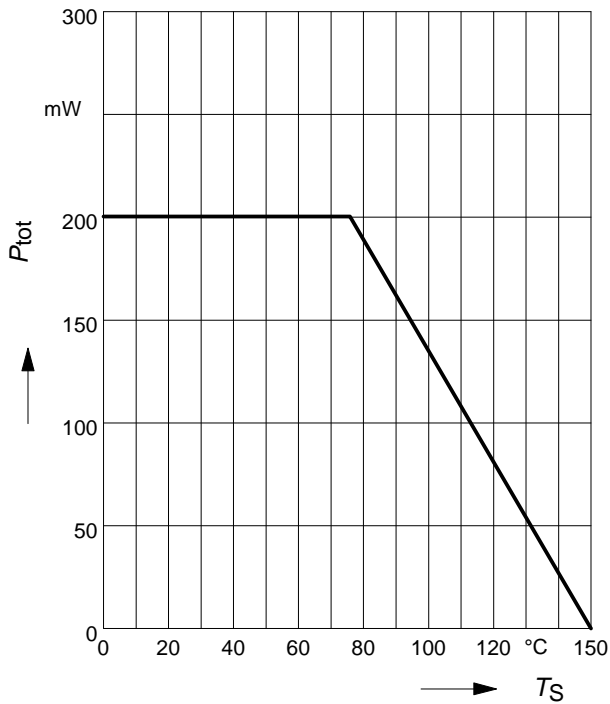

Drain current $I_D = f(V_{G2S})$

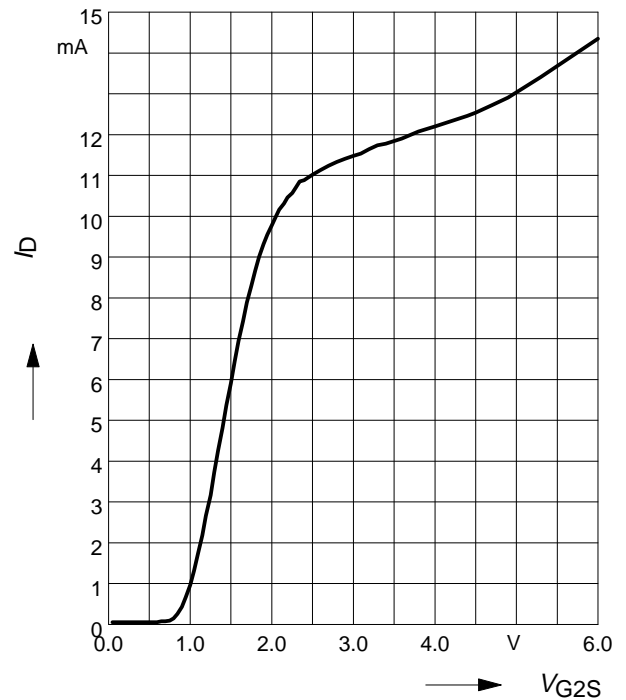

Insertion power gain

$|S_{21}|^2 = f(V_{G2S})$

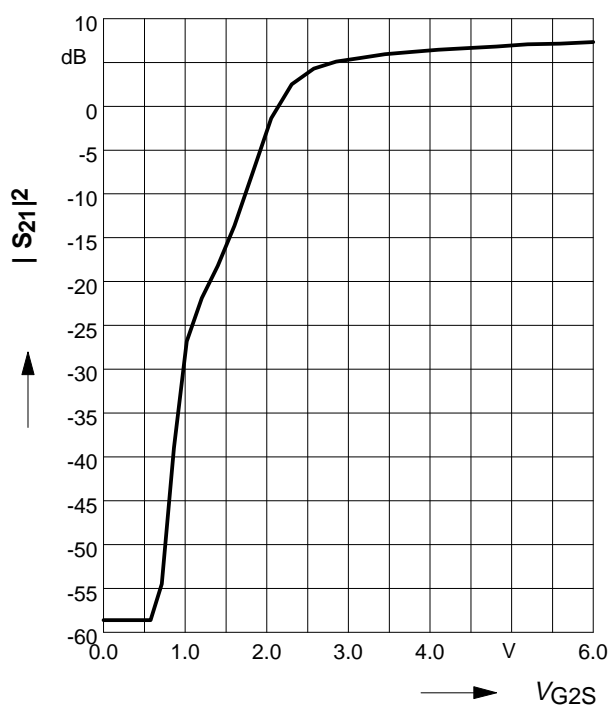

Forward transfer admittance

$|Y_{21}| = f(V_{G2S})$

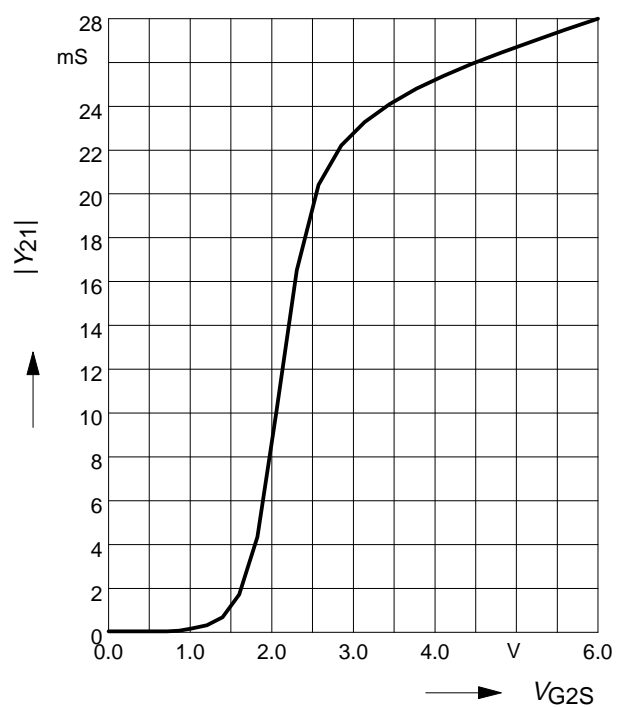

Gate 1 input capacitance $C_{g1ss} = f(V_{g2s})$
 $f = 200\text{MHz}$

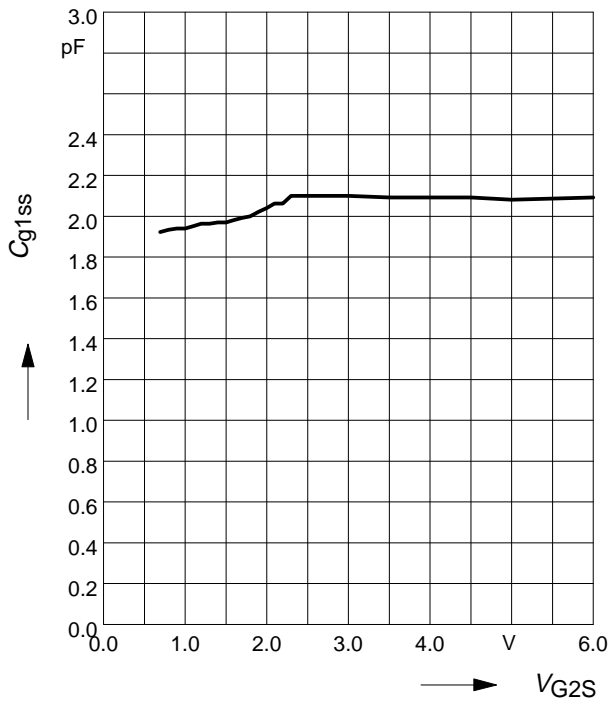

Output capacitance $C_{dss} = f(V_{G2})$
 $f = 200\text{MHz}$

