

## Silicon N Channel MOSFET Tetrode

**BF 997**

- Integrated suppression network against spurious VHF oscillations
- For VHF applications, especially in TV tuners with extended VHF band, e. g. in CATV tuners

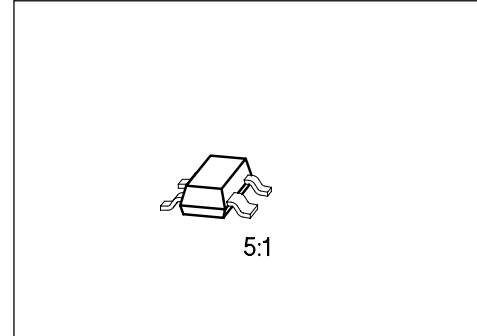

Type	Marking	Ordering Code (tape and reel)	Pin Configuration				Package <sup>1)</sup>
			1	2	3	4	
BF 997	MK	Q62702-F1055	S	D	G <sub>2</sub>	G <sub>1</sub>	SOT-143

### Maximum Ratings

Parameter	Symbol	Values	Unit
Drain-source voltage	$V_{DS}$	20	V
Drain current	$I_D$	30	mA
Gate 1/gate 2 peak source current	$\pm I_{G1/2SM}$	10	
Total power dissipation, $T_s < 76\text{ °C}$	$P_{tot}$	200	mW
Storage temperature range	$T_{stg}$	- 55 ... + 150	°C
Channel temperature	$T_{ch}$	150	

### Thermal Resistance

Junction - soldering point	$R_{th JS}$	< 370	K/W
----------------------------	-------------	-------	-----

<sup>1)</sup> For detailed information see chapter Package Outlines..

## Electrical Characteristics

at  $T_A = 25\text{ °C}$ , unless otherwise specified.

Parameter	Symbol	Values			Unit
		min.	typ.	max.	

### DC Characteristics

Drain-source breakdown voltage $I_D = 10\text{ }\mu\text{A}$ , $-V_{G1S} = -V_{G2S} = 4\text{ V}$	$V_{(BR) DS}$	20	–	–	V
Gate 1 source breakdown voltage $\pm I_{G1S} = 10\text{ mA}$ , $V_{G2S} = V_{DS} = 0$	$\pm V_{(BR) G1SS}$	8.5	–	14	
Gate 2 source breakdown voltage $\pm I_{G2S} = 10\text{ mA}$ , $V_{G1S} = V_{DS} = 0$	$\pm V_{(BR) G2SS}$	8.5	–	14	
Gate 1 source leakage current $\pm V_{G1S} = 5\text{ V}$ , $V_{G2S} = V_{DS} = 0$	$\pm I_{G1SS}$	–	–	50	nA
Gate 2 source leakage current $\pm V_{G2S} = 5\text{ V}$ , $V_{G1S} = V_{DS} = 0$	$\pm I_{G2SS}$	–	–	50	
Drain current $V_{DS} = 15\text{ V}$ , $V_{G1S} = 0$ , $V_{G2S} = 4\text{ V}$	$I_{DSS}$	2	–	20	mA
Gate 1 source pinch-off voltage $V_{DS} = 15\text{ V}$ , $V_{G2S} = 4\text{ V}$ , $I_D = 20\text{ }\mu\text{A}$	$-V_{G1S(p)}$	–	–	2.5	V
Gate 2 source pinch-off voltage $V_{DS} = 15\text{ V}$ , $V_{G1S} = 0$ , $I_D = 20\text{ }\mu\text{A}$	$-V_{G2S(p)}$	–	–	2.0	

## Electrical Characteristics

at  $T_A = 25\text{ °C}$ , unless otherwise specified.

Parameter	Symbol	Values			Unit
		min.	typ.	max.	

## AC Characteristics

Forward transconductance $V_{DS} = 15\text{ V}$ , $I_D = 10\text{ mA}$ , $V_{G2S} = 4\text{ V}$ , $f = 1\text{ kHz}$	$g_{fs}$	15	18	–	mS
Gate 1 input capacitance $V_{DS} = 15\text{ V}$ , $I_D = 10\text{ mA}$ , $V_{G2S} = 4\text{ V}$ , $f = 1\text{ MHz}$	$C_{g1ss}$	–	2.5	–	pF
Gate 2 input capacitance $V_{DS} = 15\text{ V}$ , $I_D = 10\text{ mA}$ , $V_{G2S} = 4\text{ V}$ , $f = 1\text{ MHz}$	$C_{g2ss}$	–	1.2	–	
Feedback capacitance $V_{DS} = 15\text{ V}$ , $I_D = 10\text{ mA}$ , $V_{G2S} = 4\text{ V}$ , $f = 1\text{ MHz}$	$C_{dg1}$	–	25	–	fF
Output capacitance $V_{DS} = 15\text{ V}$ , $I_D = 10\text{ mA}$ , $V_{G2S} = 4\text{ V}$ , $f = 1\text{ MHz}$	$C_{dss}$	–	1	–	pF
Power gain $V_{DS} = 15\text{ V}$ , $I_D = 10\text{ mA}$ $f = 200\text{ MHz}$ , $G_G = 2\text{ mS}$ , $G_L = 0.5\text{ mS}$ (test circuit)	$G_{ps}$	–	25	–	dB
Noise figure $V_{DS} = 15\text{ V}$ , $I_D = 10\text{ mA}$ $f = 200\text{ MHz}$ , $G_G = 2\text{ mS}$ , $G_L = 0.5\text{ mS}$ (test circuit)	$F$	–	1	–	
Gain control range $V_{DS} = 15\text{ V}$ , $V_{G2S} = 4 \dots - 2\text{ V}$ , $f = 200\text{ MHz}$ (test circuit)	$\Delta G_{ps}$	50	–	–	

Total power dissipation  $P_{tot} = f(T_A)$

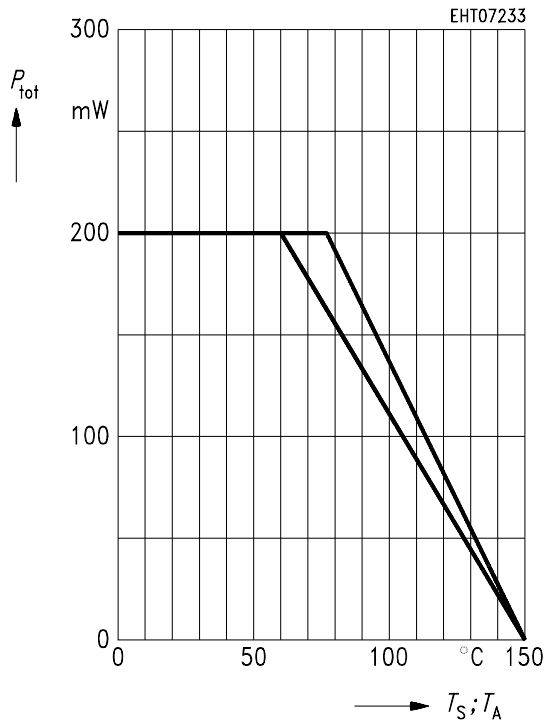

Output characteristics  $I_D = f(V_{DS})$

$V_{G2S} = 4 V$

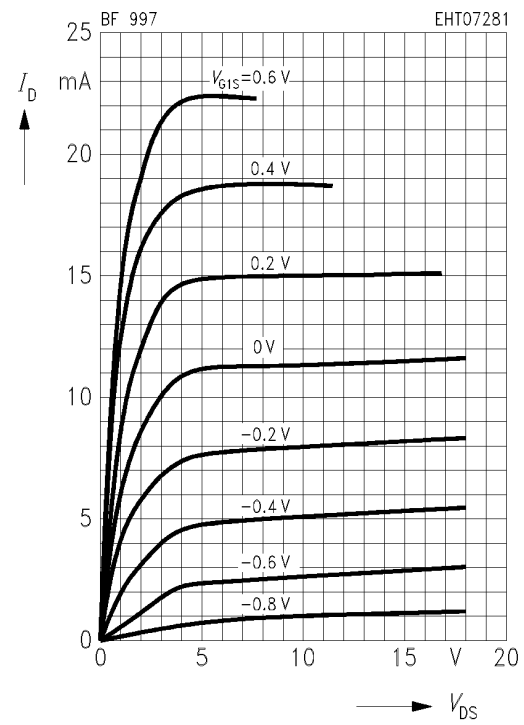

Gate 1 forward transconductance

$g_{fs1} = f(V_{G1S})$

$V_{DS} = 15 V, I_{DSS} = 10 mA, f = 1 kHz$

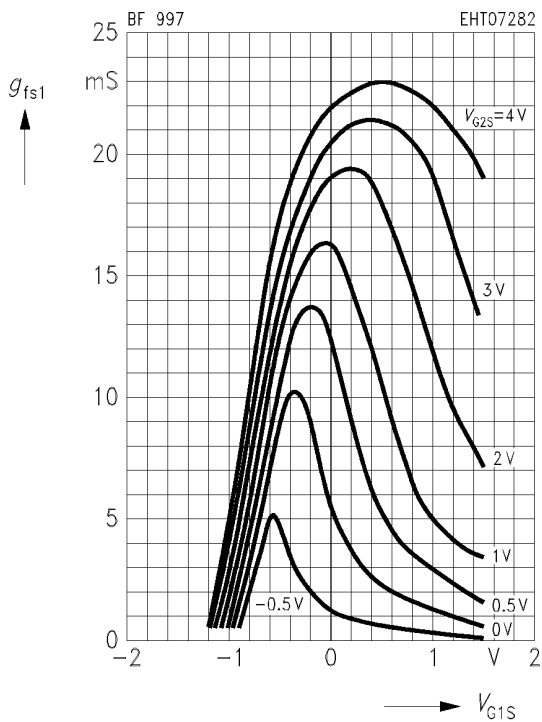

Gate 1 forward transconductance

$g_{fs1} = f(V_{G2S})$

$V_{DS} = 15 V, I_{DSS} = 10 mA, f = 1 kHz$

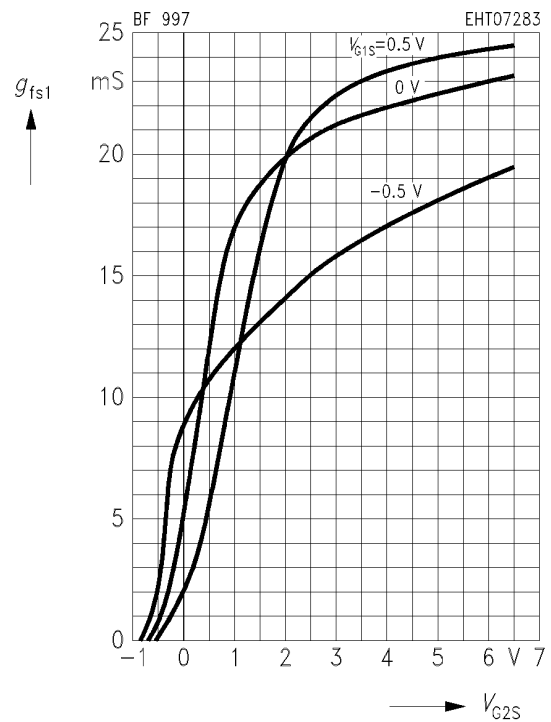

**Drain current  $I_D = f(V_{G1S})$**

$V_{DS} = 15\text{ V}$

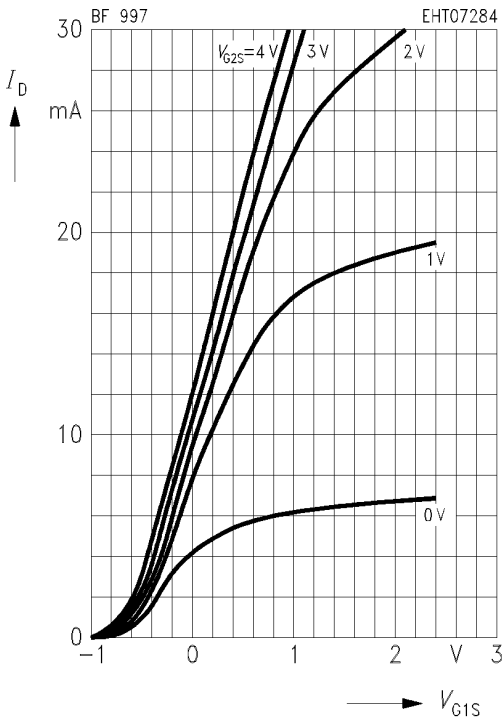

**Gate 1 input capacitance  $C_{g1ss} = f(V_{G1S})$**

$V_{G2S} = 4\text{ V}$ ,  $V_{DS} = 15\text{ V}$

$I_{DSS} = 10\text{ mA}$ ,  $f = 1\text{ MHz}$

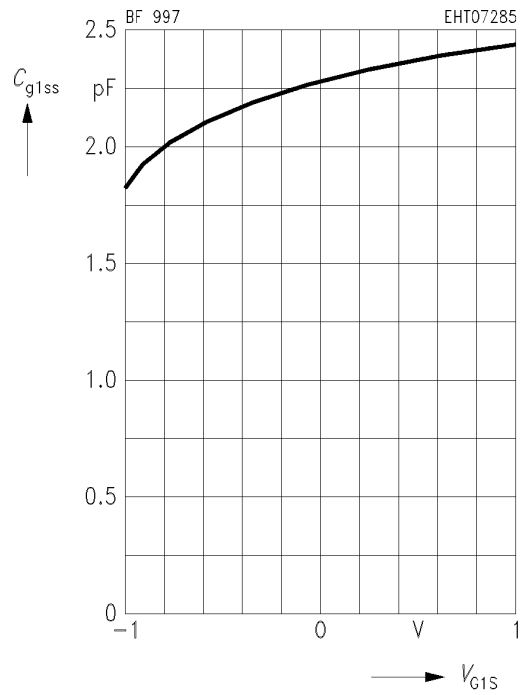

**Gate 2 input capacitance  $C_{g2ss} = f(V_{G2S})$**

$V_{G1S} = 0\text{ V}$ ,  $V_{DS} = 15\text{ V}$

$I_{DSS} = 10\text{ mA}$ ,  $f = 1\text{ MHz}$

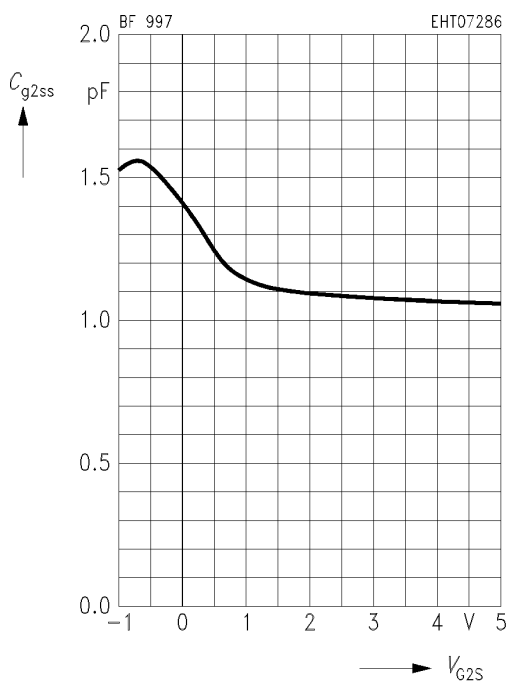

**Output capacitance  $C_{dss} = f(V_{DS})$**

$V_{G1S} = 0\text{ V}$ ,  $V_{G2S} = 4\text{ V}$

$I_{DSS} = 10\text{ mA}$ ,  $f = 1\text{ MHz}$

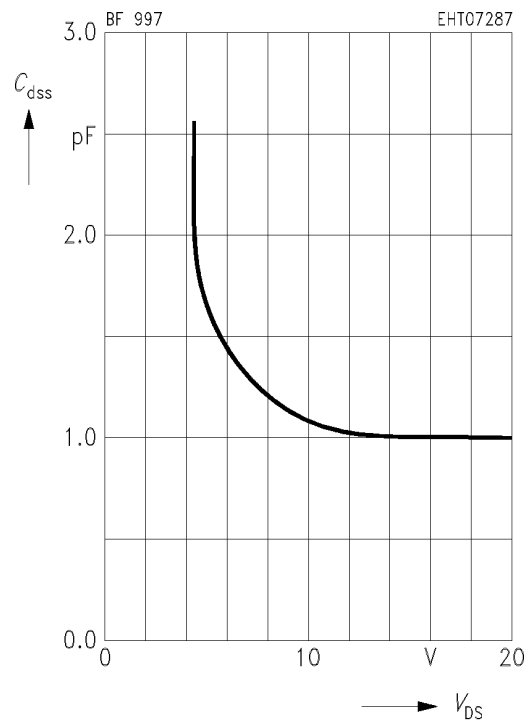

**Gate 1 input admittance  $y_{11s}$**

$V_{DS} = 15\text{ V}$ ,  $V_{G2S} = 4\text{ V}$   
(common source)

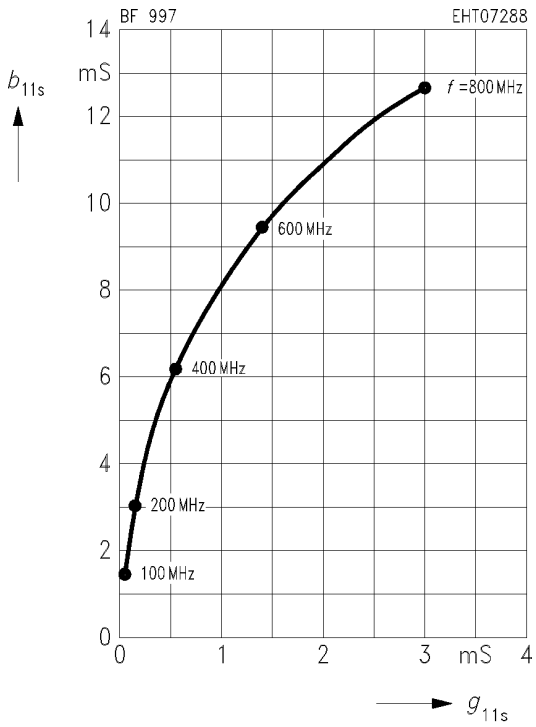

**Gate 1 forward transfer admittance  $y_{21s}$**

$V_{DS} = 15\text{ V}$ ,  $V_{G2S} = 4\text{ V}$   
(common source)

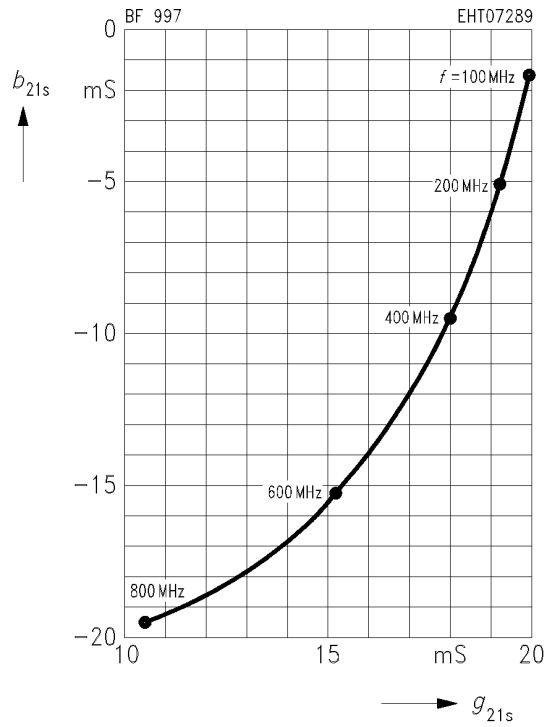

**Output admittance  $y_{22s}$**

$V_{DS} = 15\text{ V}$ ,  $V_{G2S} = 4\text{ V}$   
(common source)

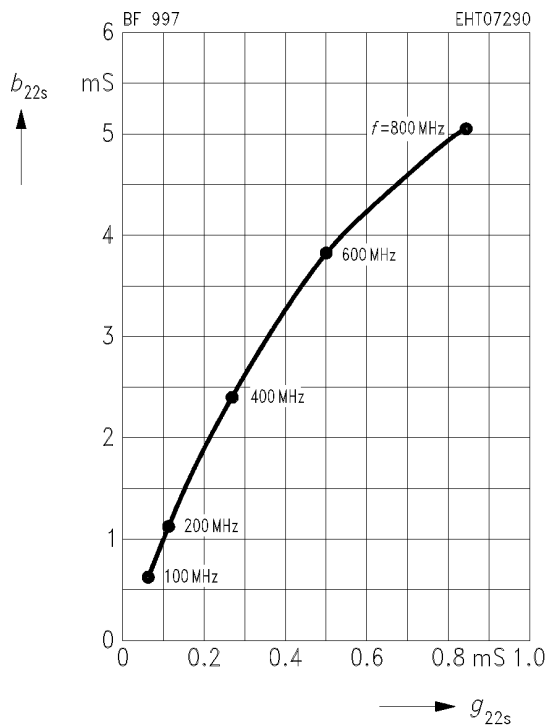

**Power gain  $G_{ps} = f(V_{G2S})$**

$V_{DS} = 15\text{ V}$ ,  $V_{G1S} = 0\text{ V}$ ,  $I_{DSS} = 10\text{ mA}$   
 $f = 200\text{ MHz}$  (see test circuit)

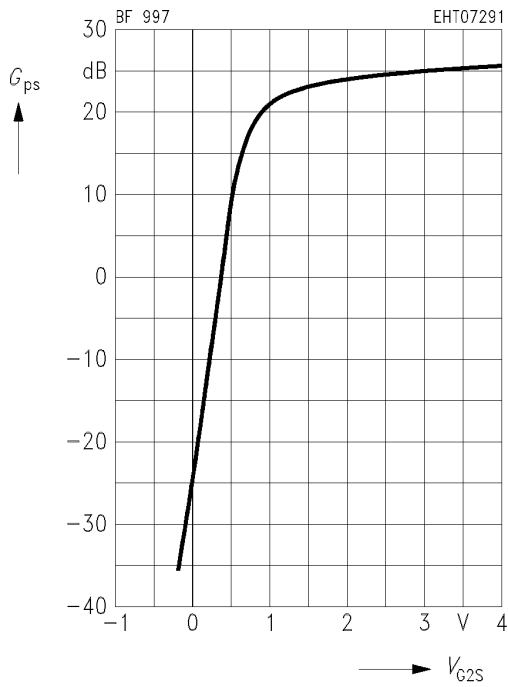

**Noise figure  $F = f(V_{G2S})$**

$V_{DS} = 15\text{ V}$ ,  $V_{G1S} = 0\text{ V}$ ,  $I_{DSS} = 10\text{ mA}$   
 $f = 200\text{ MHz}$ , (see test circuit)

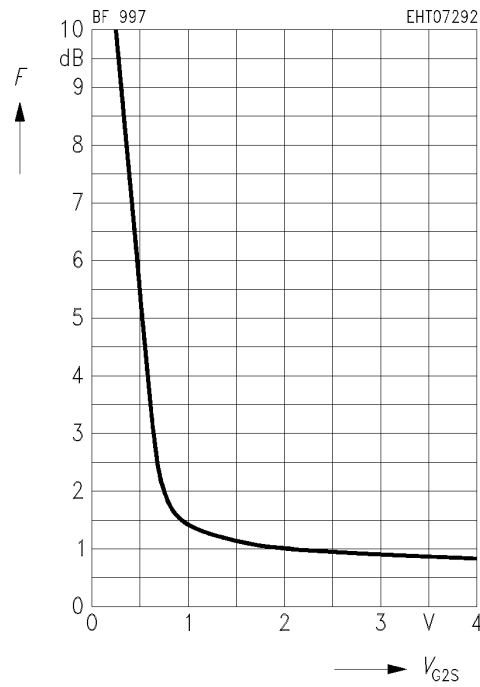

**Test circuit for power gain and noise figure**

$f = 200\text{ MHz}$ ,  $G_G = 2\text{ mS}$ ,  $G_L = 0.5\text{ mS}$

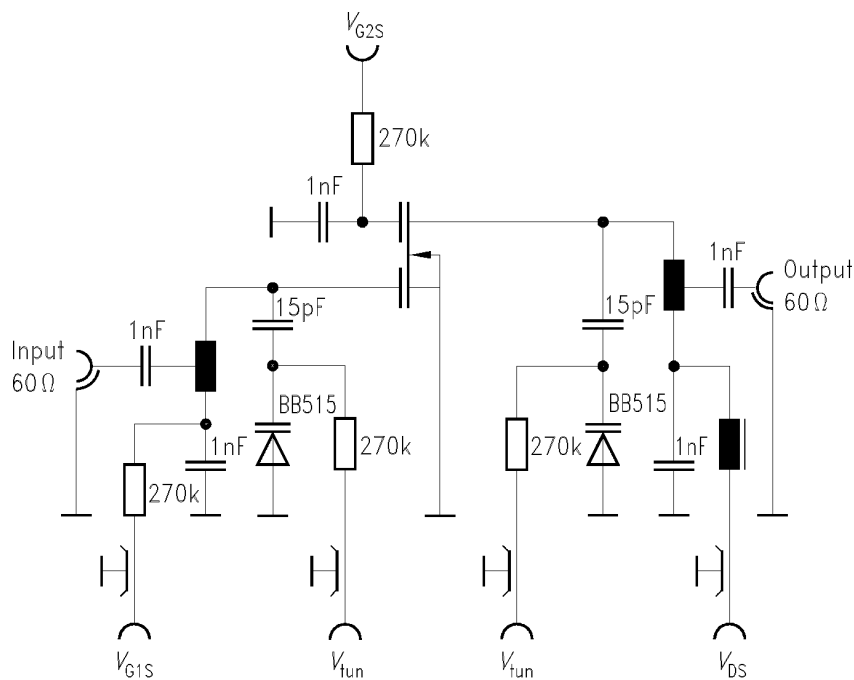

EHM07021