

$$V_{DS} = 1000 \text{ V}$$

$$I_D = 28 \text{ A}$$

$$R_{DS(on)} = 0.42 \text{ } \Omega$$

- Power module
- Single switch
- FREDFET
- N channel
- Enhancement mode
- Package with insulated metal base plate
- Package outline/Circuit diagram: 1<sup>1)</sup>

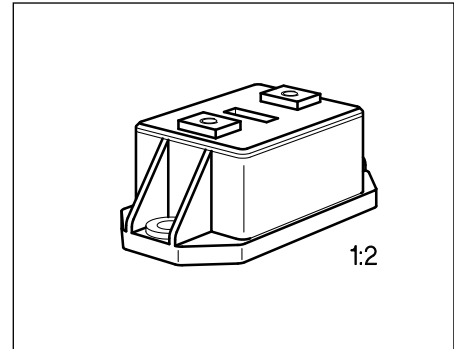

Type	Ordering Code
BSM 191 F	C67076-A1053-A2

### Maximum Ratings

Parameter	Symbol	Values	Unit
Drain-source voltage	$V_{DS}$	1000	V
Drain-gate voltage, $R_{GS} = 20 \text{ k}\Omega$	$V_{DGR}$	1000	
Gate-source voltage	$V_{GS}$	$\pm 20$	
Continuous drain current, $T_C = 25 \text{ }^\circ\text{C}$	$I_D$	28	A
Pulsed drain current, $T_C = 25 \text{ }^\circ\text{C}$	$I_{D \text{ puls}}$	110	
Operating and storage temperature range	$T_j, T_{stg}$	$- 55 \dots + 150$	$^\circ\text{C}$
Power dissipation, $T_C = 25 \text{ }^\circ\text{C}$	$P_{tot}$	700	W
Thermal resistance Chip-case	$R_{th \text{ JC}}$	$\leq 0.18$	K/W
Insulation test voltage <sup>2)</sup> , $t = 1 \text{ min.}$	$V_{is}$	2500	$V_{ac}$
Creepage distance, drain-source	–	16	mm
Clearance, drain-source	–	11	
DIN humidity category, DIN 40 040	–	F	–
IEC climatic category, DIN IEC 68-1	–	55/150/56	

1) See chapter Package Outline and Circuit Diagrams.

2) Insulation test voltage between drain and base plate referred to standard climate 23/50 in acc. with DIN 50 014, IEC 146, para. 492.1.

## Electrical Characteristics

at  $T_j = 25\text{ °C}$ , unless otherwise specified.

Parameter	Symbol	Values			Unit
		min.	typ.	max.	

## Static Characteristics

Drain-source breakdown voltage $V_{GS} = 0, I_D = 0.25\text{ mA}$	$V_{(BR)DSS}$	1000	–	–	V
Gate threshold voltage $V_{GS} = V_{DS}, I_D = 1\text{ mA}$	$V_{GS(th)}$	2.1	3.0	4.0	
Zero gate voltage drain current $V_{DS} = 1000\text{ V}, V_{GS} = 0$ $T_j = 25\text{ °C}$ $T_j = 125\text{ °C}$	$I_{DSS}$	– –	50 300	250 1000	$\mu\text{A}$
Gate-source leakage current $V_{GS} = 20\text{ V}, V_{DS} = 0$	$I_{GSS}$	–	10	100	nA
Drain-source on-state resistance $V_{GS} = 10\text{ V}, I_D = 18\text{ A}$	$R_{DS(on)}$	–	0.38	0.42	$\Omega$

## Dynamic Characteristics

Forward transconductance $V_{DS} \geq 2 \times I_D \times R_{DS(on)max.}, I_D = 18\text{ A}$	$g_{fs}$	15	22	–	S
Input capacitance $V_{GS} = 0, V_{DS} = 25\text{ V}, f = 1\text{ MHz}$	$C_{iss}$	–	22	30	nF
Output capacitance $V_{GS} = 0, V_{DS} = 25\text{ V}, f = 1\text{ MHz}$	$C_{oss}$	–	1.0	1.5	
Reverse transfer capacitance $V_{GS} = 0, V_{DS} = 25\text{ V}, f = 1\text{ MHz}$	$C_{rss}$	–	0.36	0.5	
Turn-on time $t_{on}$ ( $t_{on} = t_{d(on)} + t_r$ ) $V_{CC} = 500\text{ V}, V_{GS} = 10\text{ V}$ $I_D = 18\text{ A}, R_{GS} = 3.3\text{ }\Omega$	$t_{d(on)}$	–	60	–	ns
	$t_r$	–	30	–	
Turn-off time $t_{off}$ ( $t_{off} = t_{d(off)} + t_f$ ) $V_{CC} = 500\text{ V}, V_{GS} = 10\text{ V}$ $I_D = 18\text{ A}, R_{GS} = 3.3\text{ }\Omega$	$t_{d(off)}$	–	350	–	
	$t_f$	–	60	–	

## Electrical Characteristics (cont'd)

at  $T_j = 25\text{ °C}$ , unless otherwise specified.

Parameter	Symbol	Values			Unit
		min.	typ.	max.	

### Fast recovery reverse diode

Continuous reverse drain current $T_C = 25\text{ °C}$	$I_S$	–	–	28	A
Pulsed reverse drain current $T_C = 25\text{ °C}$	$I_{SM}$	–	–	110	
Diode forward on-voltage <sup>1)</sup> $I_F = 56\text{ A}$ , $V_{GS} = 0$	$V_{SD}$	–	1.2	1.6	V
Reverse recovery time $I_F = I_S$ , $di_F/dt = 100\text{ A}/\mu\text{s}$ , $V_R = 100\text{ V}$	$t_{rr}$	–	300	–	ns
Reverse recovery charge $I_F = I_S$ , $di_F/dt = 100\text{ A}/\mu\text{s}$ , $V_R = 100\text{ V}$	$Q_{rr}$	–	2.2	–	$\mu\text{C}$

<sup>1)</sup> upon request

Characteristics at  $T_j = 25\text{ }^\circ\text{C}$ , unless otherwise specified.

**Power dissipation**  $P_{tot} = f(T_C)$   
parameter:  $T_j = 150\text{ }^\circ\text{C}$

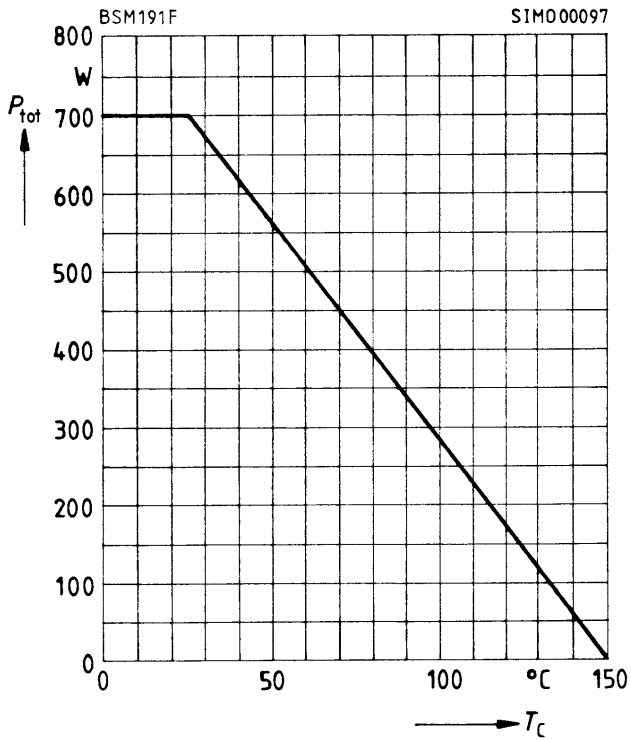

**Typ. output characteristics**  $I_D = f(V_{DS})$   
parameter:  $t_p = 80\text{ }\mu\text{s}$

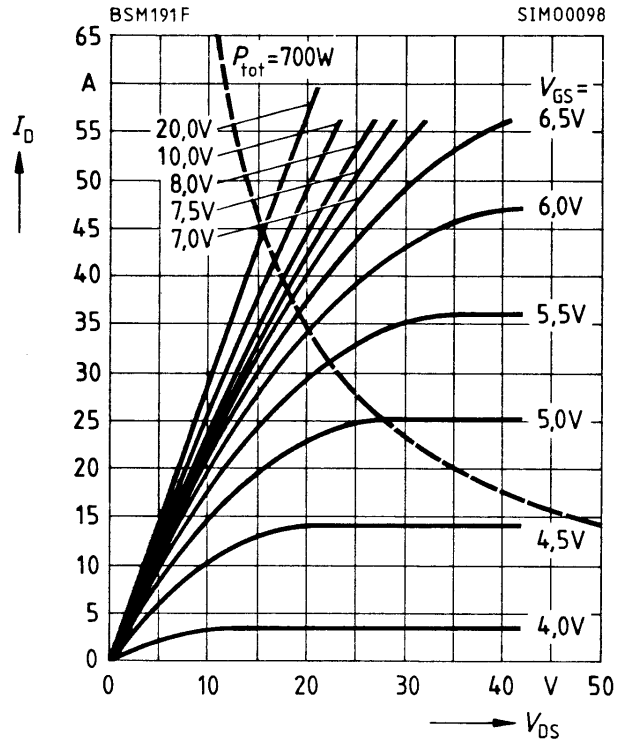

**Safe operating area**  $I_D = f(V_{DS})$   
parameter: single pulse,  $T_C = 25\text{ }^\circ\text{C}$ ,  
 $T_j \leq 150\text{ }^\circ\text{C}$

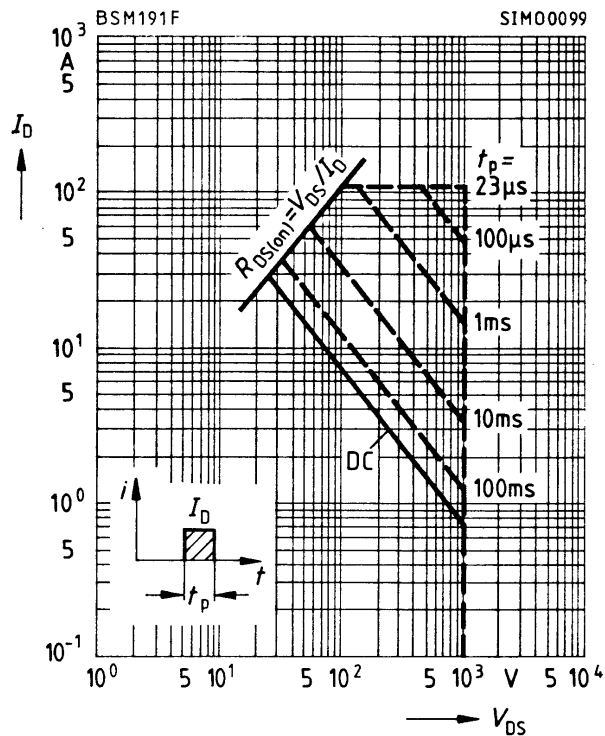

**Typ. transfer characteristic**  $I_D = f(V_{GS})$   
parameter:  $t_p = 80\text{ }\mu\text{s}$ ,  $V_{DS} = 25\text{ V}$

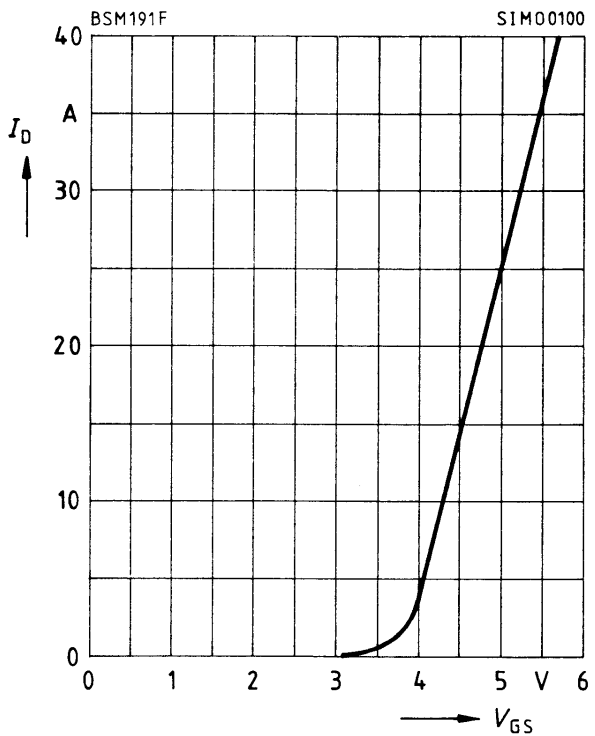

**Continuous drain current  $I_D = f(T_C)$**   
 parameter:  $V_{GS} \geq 10 \text{ V}$ ,  $T_j = 150 \text{ }^\circ\text{C}$

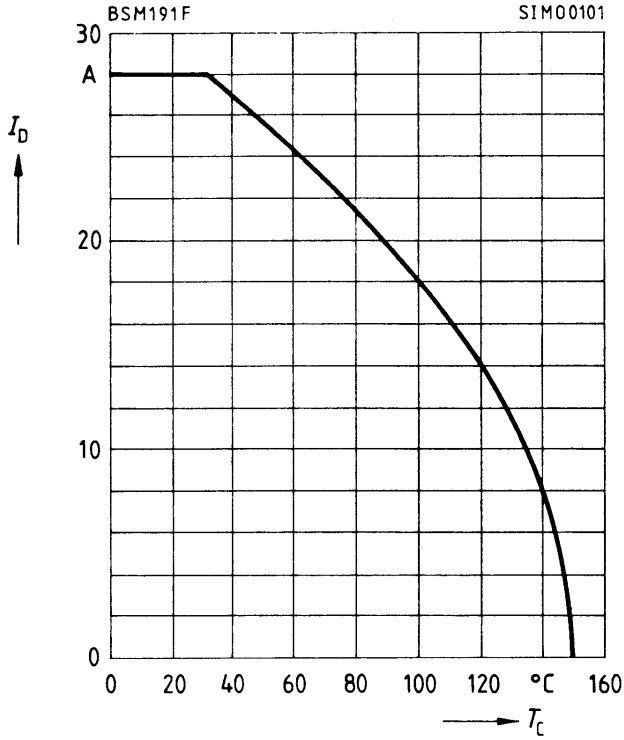

**Drain-source breakdown voltage  $V_{(BR)DSS}(T_j) = b \times V_{(BR)DSS}(25 \text{ }^\circ\text{C})$**

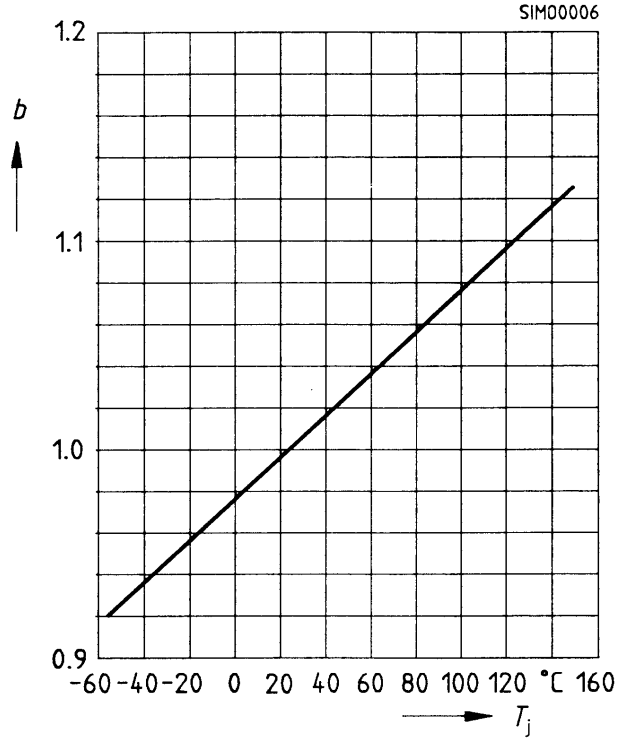

**Drain-source on-state resistance  $R_{DS(on)} = f(T_j)$**   
 parameter:  $I_D = 18 \text{ A}$ ;  $V_{GS} = 10 \text{ V}$  (spread)

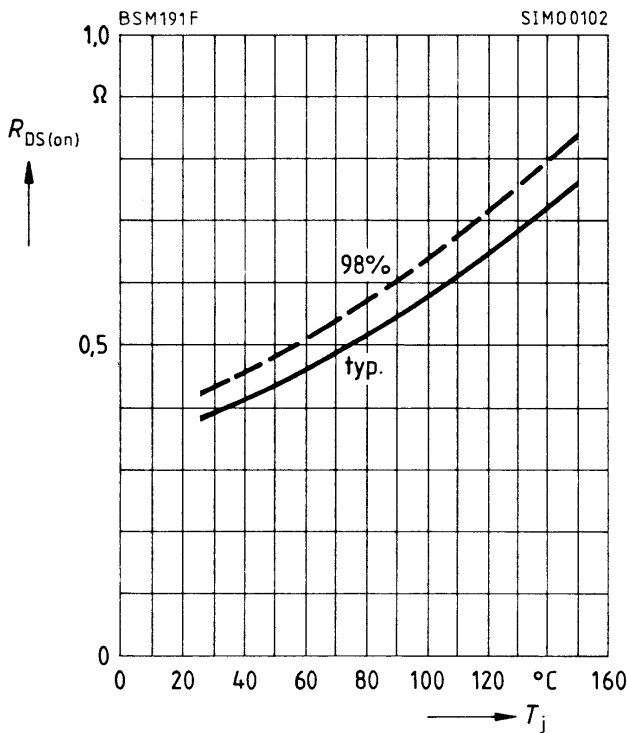

**Typ. capacitances  $C = f(V_{DS})$**   
 parameter:  $V_{GS} = 0$ ,  $f = 1 \text{ MHz}$

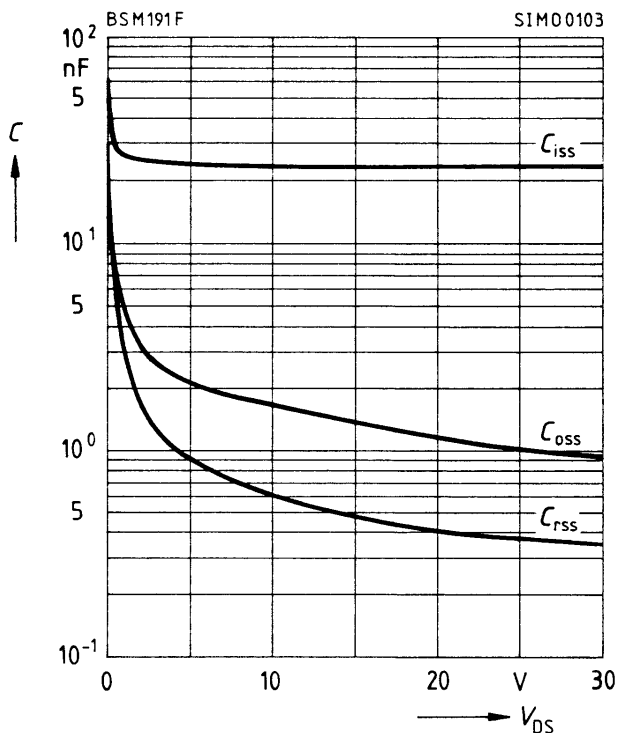

**Typ. reverse recovery charge  $Q_{rr} = f(T_j)$**

parameter:  $di_F/dt = 100 \text{ A}/\mu\text{s}$ ,

$I_F = 28 \text{ A}$ ,  $V_R = 100 \text{ V}$

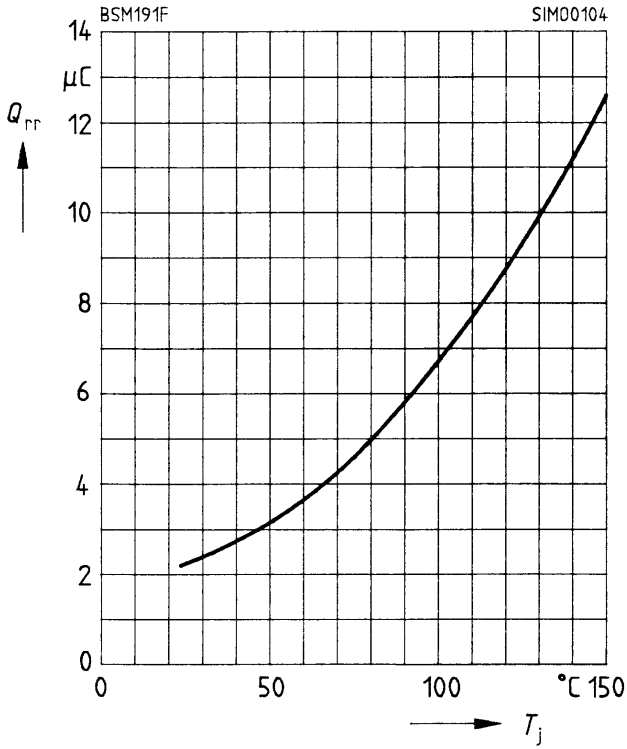

**Forward characteristics of fast-recovery reverse diode  $I_F = f(V_{SD})$**

parameter:  $T_j, t_p = 80 \mu\text{s}$  (spread)

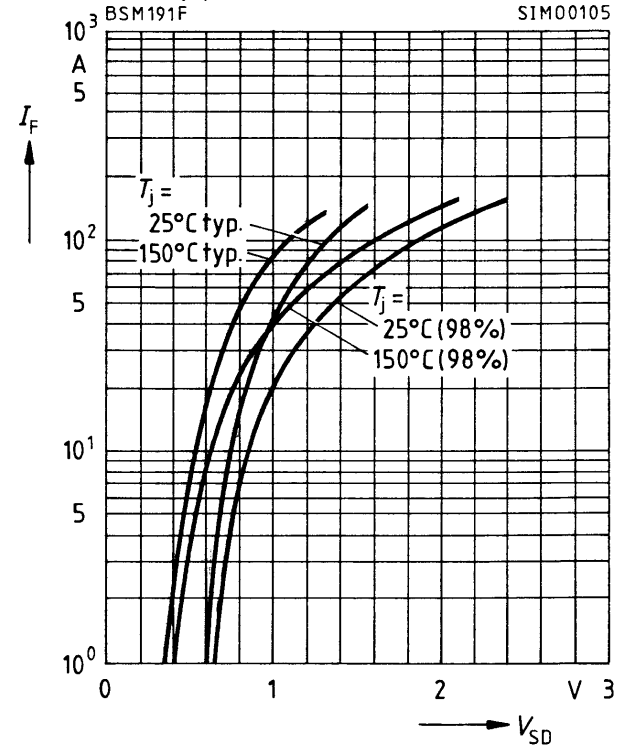

### Transient thermal impedance $Z_{thJC} = f(t_p)$

parameter:  $D = t_p/T$

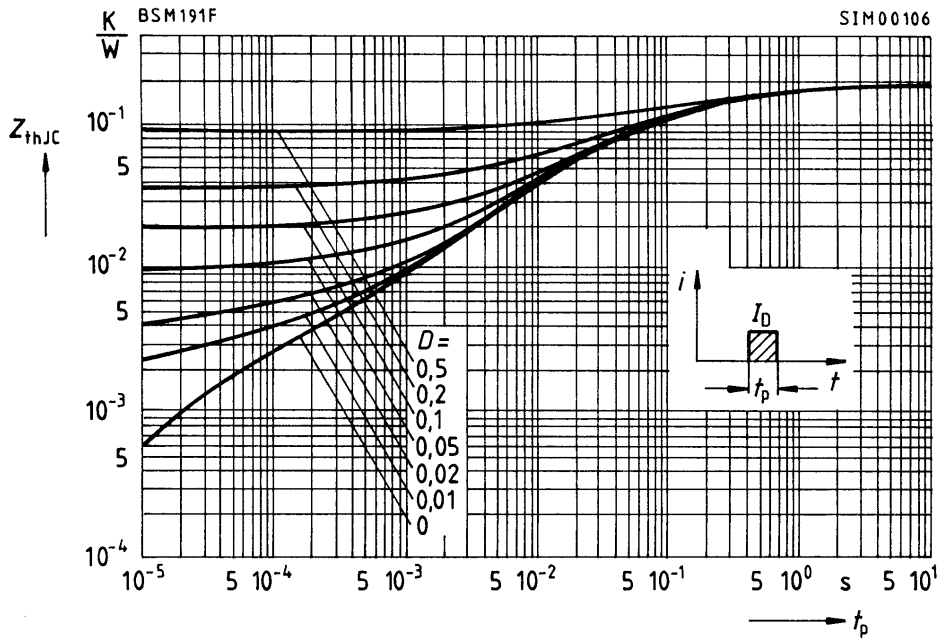

### Typ. gate charge $V_{GS} = f(Q_{Gate})$

parameter:  $I_{Dpuls} = 42$  A

