

### Features

- N channel
- Logic level
- Enhancement mode
- Temperature sensor with thyristor characteristic
- The drain pin is electrically shorted to the tab

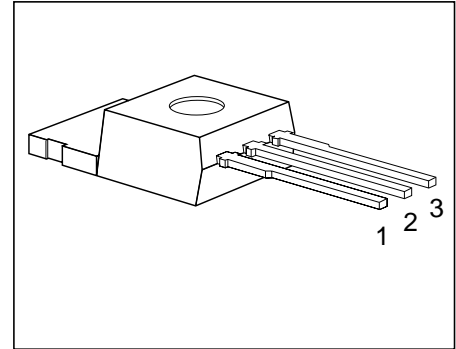

Pin	1	2	3
	G	D	S

Type	$V_{DS}$	$I_D$	$R_{DS(on)}$	Package	Ordering Code
BTS 115A	50 V	15.5 A	0.12 $\Omega$	TO-220AB	C67078-S5004-A2

### Maximum Ratings

Parameter	Symbol	Values	Unit
Drain-source voltage	$V_{DS}$	50	V
Drain-gate voltage, $R_{GS} = 20 \text{ k}\Omega$	$V_{DGR}$	50	
Gate-source voltage	$V_{GS}$	$\pm 10$	
Continuous drain current, $T_C = 25 \text{ }^\circ\text{C}$	$I_D$	15.5	A
ISO drain current $T_C = 85 \text{ }^\circ\text{C}$ , $V_{GS} = 4.5 \text{ V}$ , $V_{DS} = 0.5 \text{ V}$	$I_{D-ISO}$	3.2	
Pulsed drain current, $T_C = 25 \text{ }^\circ\text{C}$	$I_{D \text{ puls}}$	62	
Short circuit current, $T_j = -55 \dots +150 \text{ }^\circ\text{C}$	$I_{SC}$	37	
Short circuit dissipation, $T_j = -55 \dots +150 \text{ }^\circ\text{C}$	$P_{SCmax}$	550	W
Power dissipation	$P_{tot}$	50	
Operating and storage temperature range	$T_j, T_{stg}$	$-55 \dots +150$	$^\circ\text{C}$
DIN humidity category, DIN 40 040	–	E	–
IEC climatic category, DIN IEC 68-1	–	55/150/56	
Thermal resistance			K/W
Chip-case	$R_{th \text{ JC}}$	$\leq 2.5$	
Chip-ambient	$R_{th \text{ JA}}$	$\leq 75$	

## Electrical Characteristics

at  $T_j = 25\text{ °C}$ , unless otherwise specified.

Parameter	Symbol	Values			Unit
		min.	typ.	max.	

## Static Characteristics

Drain-source breakdown voltage $V_{GS} = 0, I_D = 0.25\text{ mA}$	$V_{(BR)DSS}$	50	–	–	V
Gate threshold voltage $V_{GS} = V_{DS}, I_D = 1.0\text{ mA}$	$V_{GS(th)}$	1.5	2.0	2.5	
Zero gate voltage drain current $V_{GS} = 0\text{ V}, V_{DS} = 50\text{ V}$ $T_j = 25\text{ °C}$ $T_j = 125\text{ °C}$	$I_{DSS}$	– –	0.1 10	1.0 100	$\mu\text{A}$
Gate-source leakage current $V_{GS} = 20\text{ V}, V_{DS} = 0$ $T_j = 25\text{ °C}$ $T_j = 150\text{ °C}$	$I_{GSS}$	– –	10 2	100 4	nA $\mu\text{A}$
Drain-source on-state resistance $V_{GS} = 4.5\text{ V}, I_D = 7.8\text{ A}$	$R_{DS(on)}$	–	0.09	0.12	$\Omega$

## Dynamic Characteristics

Forward transconductance $V_{DS} \geq 2 \times I_D \times R_{DS(on)max}, I_D = 7.8\text{ A}$	$g_{fs}$	5.5	9.5	–	S
Input capacitance $V_{GS} = 0, V_{DS} = 25\text{ V}, f = 1\text{ MHz}$	$C_{iss}$	–	550	735	$\mu\text{F}$
Output capacitance $V_{GS} = 0, V_{DS} = 25\text{ V}, f = 1\text{ MHz}$	$C_{oss}$	–	220	320	
Reverse transfer capacitance $V_{GS} = 0, V_{DS} = 25\text{ V}, f = 1\text{ MHz}$	$C_{rss}$	–	85	150	
Turn-on time $t_{on}$ , ( $t_{on} = t_{d(on)} + t_r$ ) $V_{CC} = 30\text{ V}, V_{GS} = 5\text{ V}, I_D = 3\text{ A}, R_{GS} = 50\text{ }\Omega$	$t_{d(on)}$	–	15	25	ns
	$t_r$	–	70	100	
Turn-off time $t_{off}$ , ( $t_{off} = t_{d(off)} + t_f$ ) $V_{CC} = 30\text{ V}, V_{GS} = 10\text{ V}, I_D = 3\text{ A}, R_{GS} = 50\text{ }\Omega$	$t_{d(off)}$	–	70	90	
	$t_f$	–	50	70	

## Electrical Characteristics (cont'd)

at  $T_j = 25\text{ °C}$ , unless otherwise specified.

Parameter	Symbol	Values			Unit
		min.	typ.	max.	

### Reverse Diode

Continuous source current	$I_S$	–	–	15.5	A
Pulsed source current	$I_{SM}$	–	–	62	
Diode forward on-voltage $I_F = 34\text{ A}$ , $V_{GS} = 0$	$V_{SD}$	–	1.5	1.8	V
Reverse recovery time $I_F = I_S$ , $di_F/dt = 100\text{ A}/\mu\text{s}$ , $V_R = 30\text{ V}$	$t_{rr}$	–	60	–	ns
Reverse recovery charge $I_F = I_S$ , $di_F/dt = 100\text{ A}/\mu\text{s}$ , $V_R = 30\text{ V}$	$Q_{rr}$	–	0.10	–	$\mu\text{C}$

### Temperature Sensor

Forward voltage $I_{TS(on)} = 5.0\text{ mA}$ , $T_j = -55 \dots +150\text{ °C}$ Sensor override, $t_p \leq 100\text{ }\mu\text{s}$ $T_j = -55 \dots +160\text{ °C}$	$V_{TS(on)}$	–	1.3	1.4	V
		–	–	10	
Forward current $T_j = -55 \dots +150\text{ °C}$ Sensor override, $t_p \leq 100\text{ }\mu\text{s}$ $T_j = -55 \dots +160\text{ °C}$	$I_{TS(on)}$	–	–	5	mA
		–	–	600	
Holding current, $V_{TS(off)} = 5\text{ V}$ , $T_j = 25\text{ °C}$ $T_j = 150\text{ °C}$	$I_H$	0.05	0.1	0.5	
		0.05	0.2	0.3	
Switching temperature $V_{TS} = 5\text{ V}$	$T_{TS(on)}$	150	–	–	$\text{°C}$
Turn-off time $V_{TS} = 5\text{ V}$ , $I_{TS(on)} = 2\text{ mA}$	$t_{off}$	0.5	–	2.5	$\mu\text{s}$

**Examples for short-circuit protection**

at  $T_j = -55 \dots +150 \text{ }^\circ\text{C}$ , unless otherwise specified.

Parameter	Symbol	Examples			Unit
		1	2	–	
Drain-source voltage	$V_{DS}$	15	30	–	V
Gate-source voltage	$V_{GS}$	5.0	3.5	–	
Short-circuit current	$I_{SC}$	37	17	–	A
Short-circuit dissipation	$P_{SC}$	550	510	–	W
Response time $T_j = 25 \text{ }^\circ\text{C}$ , before short circuit	$t_{SC(off)}$	25	25	–	ms

**Short-circuit protection  $I_{SC} = f(V_{DS})$**

Parameter:  $V_{GS}$

Diagram to determine  $I_{SC}$  for  $T_j = -55 \dots +150 \text{ }^\circ\text{C}$

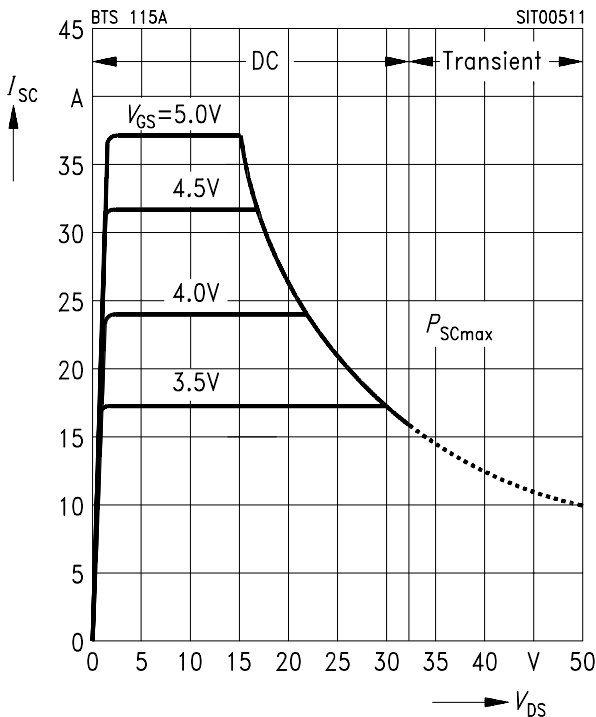

**Max. gate voltage  $V_{GS(SC)} = f(V_{DS})$**

Parameter:  $T_j = -55 \dots +150 \text{ }^\circ\text{C}$

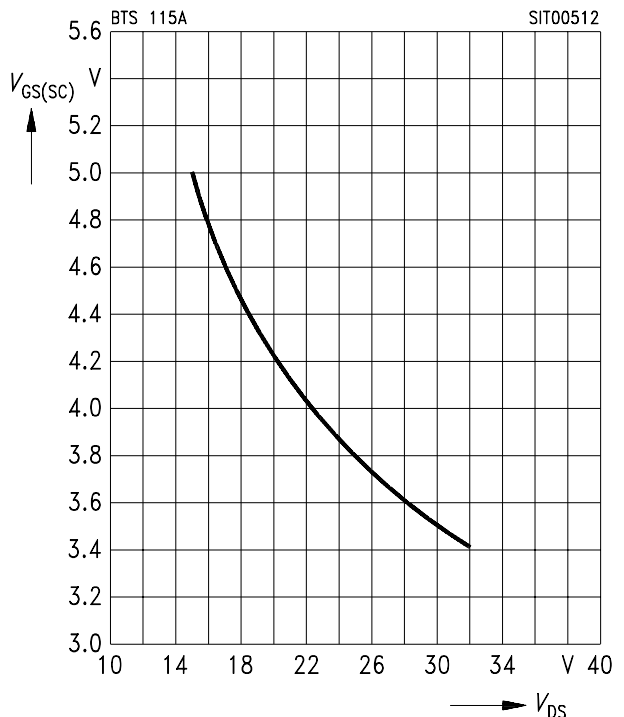

Max. power dissipation  $P_{tot} = f(T_C)$

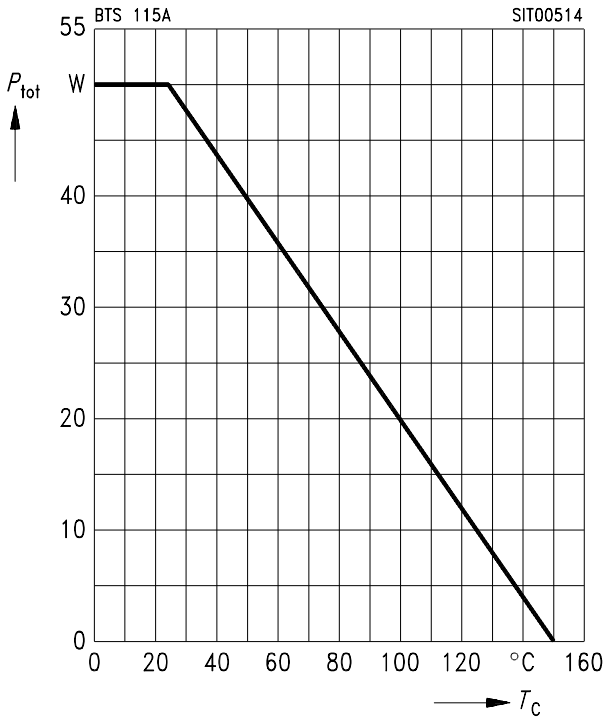

Typ. drain-source on-state resistance  $R_{DS(on)} = f(I_D)$

Parameter:  $V_{GS}$

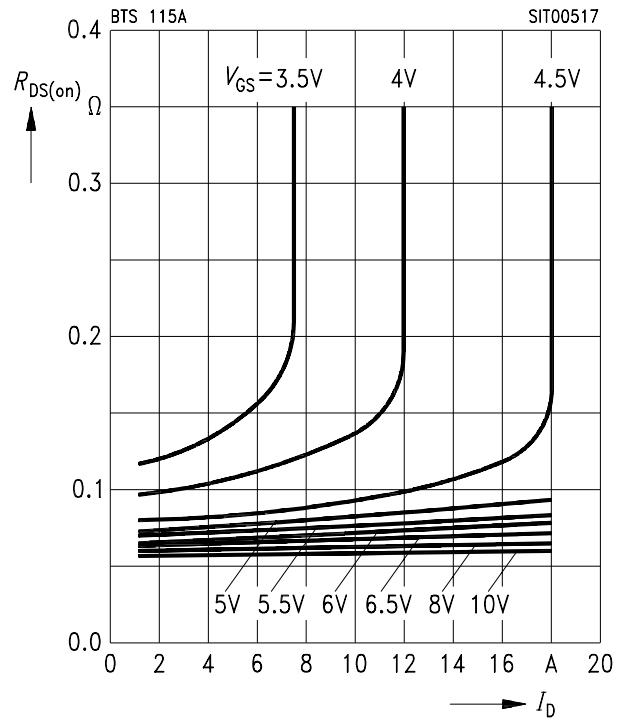

Typical output characteristics  $I_D = f(V_{DS})$

Parameter:  $t_p = 80 \mu s$

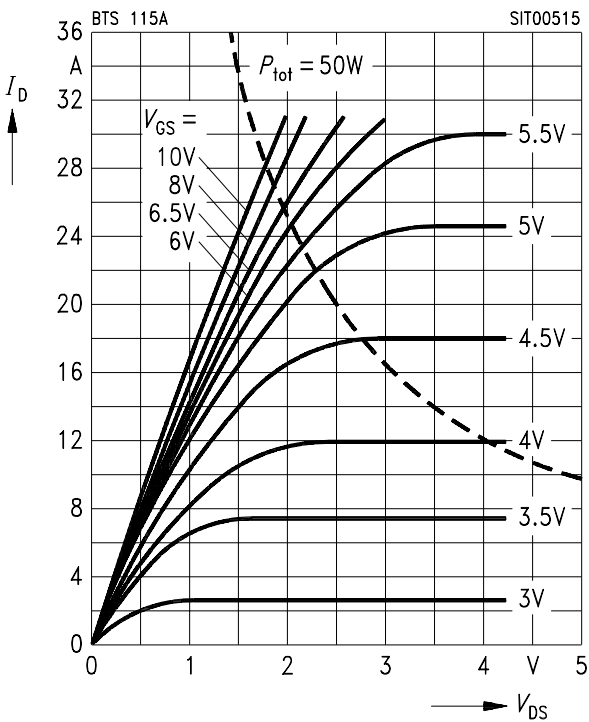

Safe operating area  $I_D = f(V_{DS})$

Parameter:  $D = 0.01, T_C = 25^\circ C$

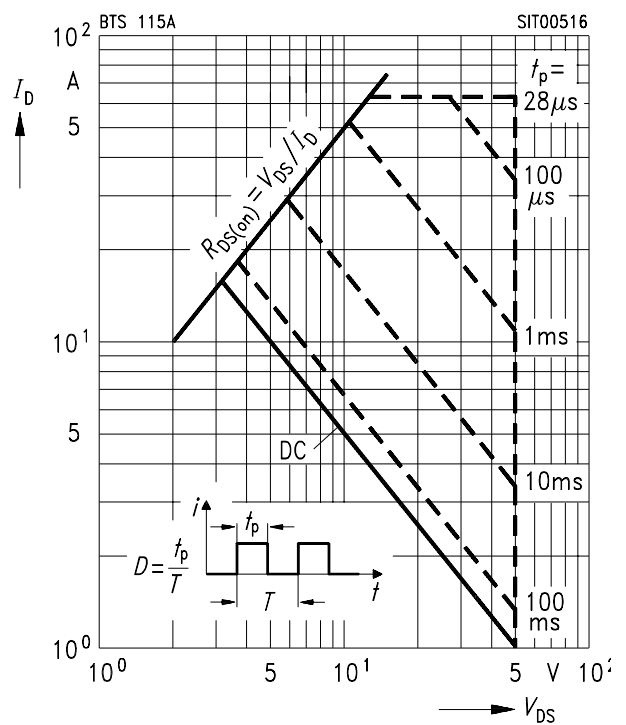

### Drain-source on-state resistance

$$R_{DS(on)} = f(T_j)$$

Parameter:  $I_D = 7.8 \text{ A}$ ,  $V_{GS} = 4.5 \text{ V}$

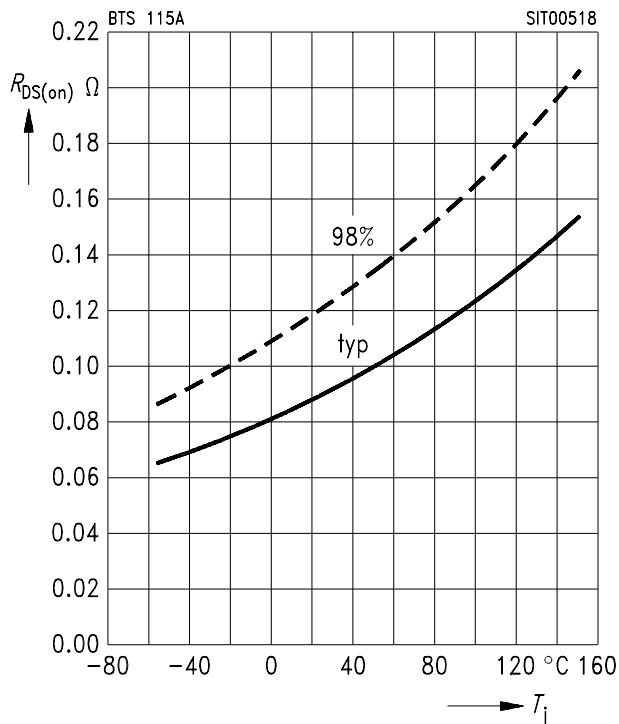

### Gate threshold voltage $V_{GS(th)} = f(T_j)$

Parameter:  $V_{DS} = V_{GS}$ ,  $I_D = -1 \text{ mA}$

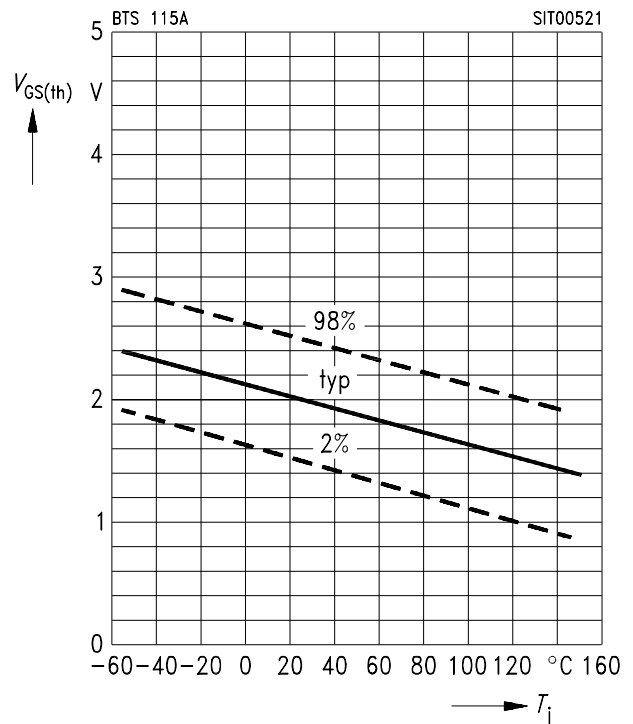

### Typ. transfer characteristic

$$I_D = f(V_{GS})$$

Parameter:  $t_p = 80 \mu\text{s}$ ,  $V_{DS} = -25 \text{ V}$

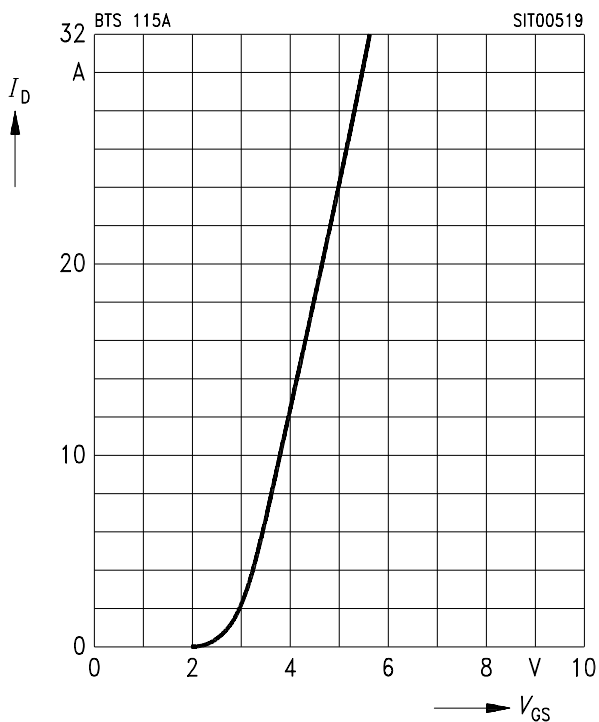

### Typ. transconductance $g_{fs} = f(I_D)$

Parameter:  $t_p = 80 \mu\text{s}$ ,  $V_{DS} = -25 \text{ V}$

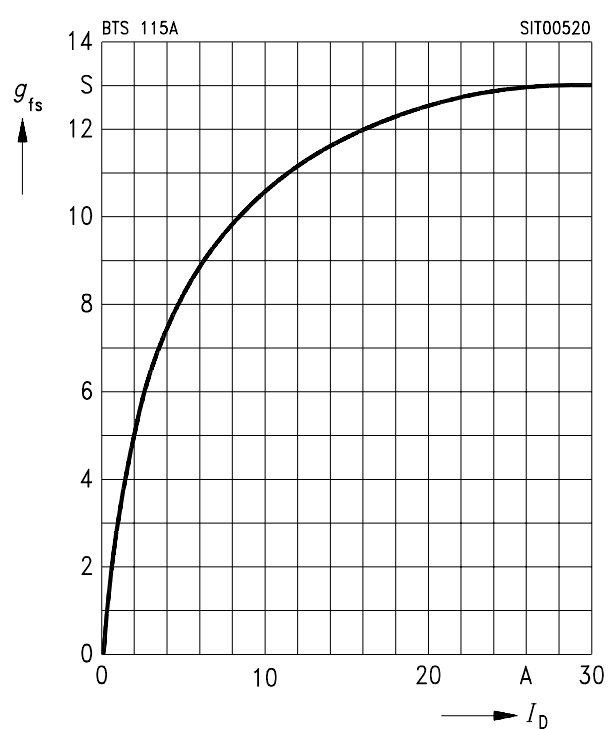

**Continuous drain current  $I_D = f(T_C)$**

Parameter:  $V_{GS} \geq 4.5 \text{ V}$

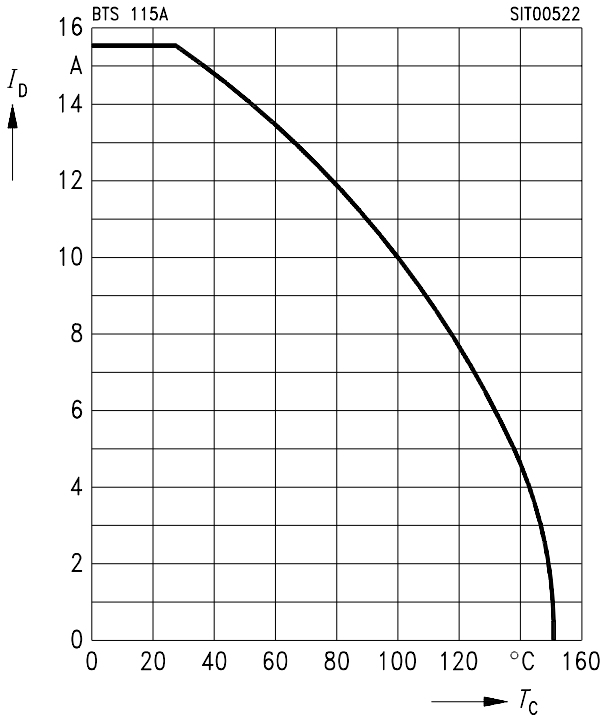

**Forward characteristics of reverse diode  $I_F = f(V_{SD})$**

Parameter:  $T_j, t_p = 80 \mu\text{s}$

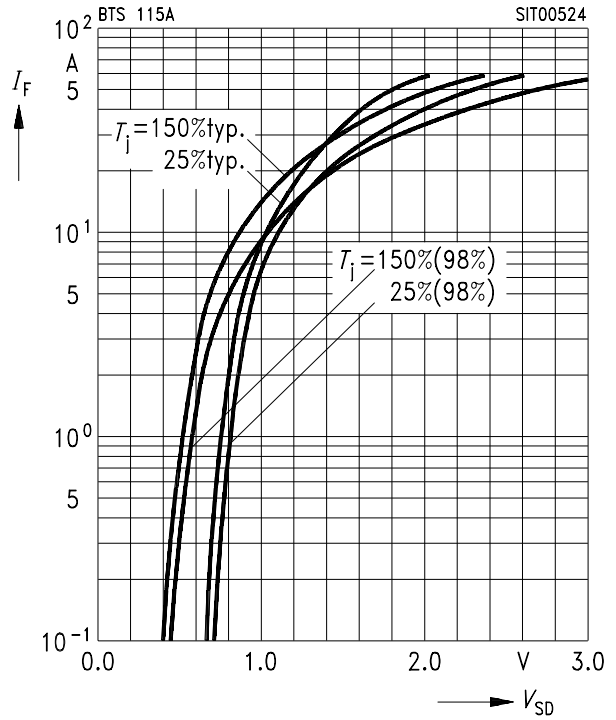

**Typ. gate-source leakage current  $I_{GSS} = f(T_C)$**

Parameter:  $V_{GS} = -20 \text{ V}, V_{DS} = 0$

Parameter:  $V_{GS} = -20 \text{ V}, V_{DS} = 0$

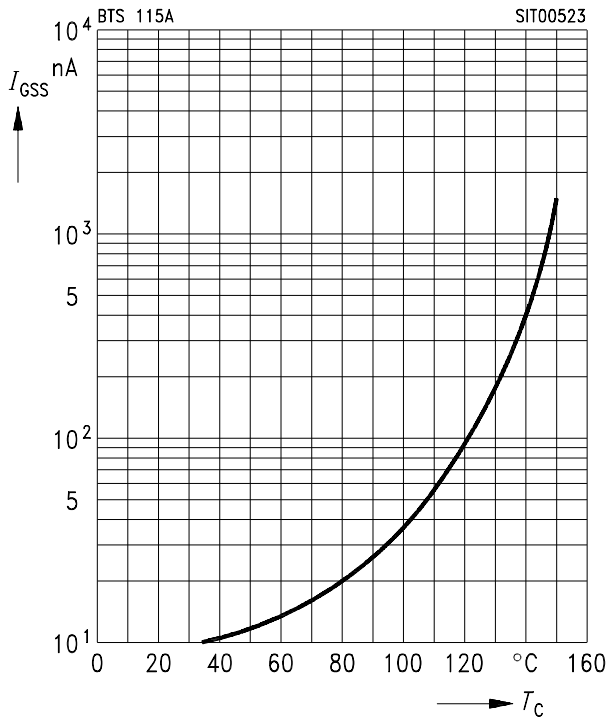

**Typ. capacitances  $C = f(V_{DS})$**

Parameter:  $V_{GS} = 0, f = 1 \text{ MHz}$

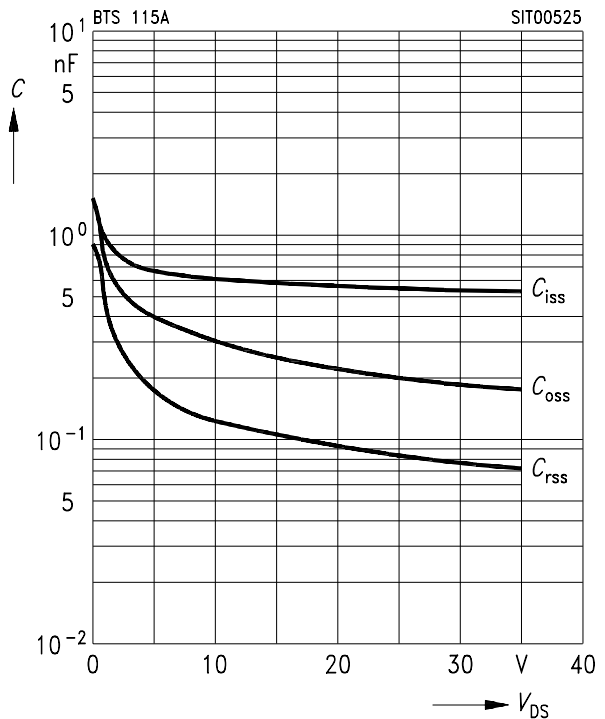

Transient thermal impedance  $Z_{thJC} = f(t_p)$   
Parameter:  $D = t_p/T$

