

### SIPMOS<sup>®</sup> Power Transistor

- N channel
- Enhancement mode
- Avalanche-rated
- Logic Level
- $dv/dt$  rated
- Low on-resistance
- 175 °C operating temperature
- also in TO-220 SMD available

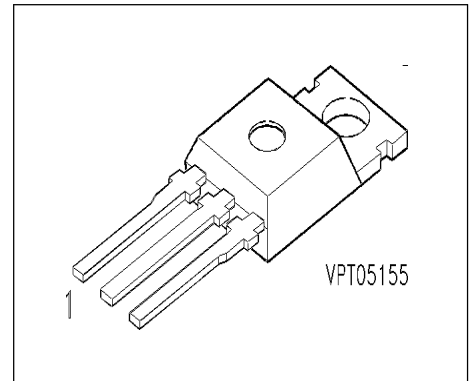

| Pin 1 | Pin 2 | Pin 3 |
|-------|-------|-------|
| G     | D     | S     |

| Type     | $V_{DS}$ | $I_D$ | $R_{DS(on)}$  | Package   | Ordering Code   |
|----------|----------|-------|---------------|-----------|-----------------|
| BUZ 101L | 50 V     | 29 A  | 0.06 $\Omega$ | TO-220 AB | C67078-S1355-A2 |

### Maximum Ratings

| Parameter  | Symbol      | Values   | Unit              |
|--|-------------|----------|-------------------|
| Continuous drain current<br>$T_C = 31\text{ °C}$   | $I_D$       | 29       | A                 |
| Pulsed drain current<br>$T_C = 25\text{ °C}$   | $I_{Dpuls}$ | 116      | A                 |
| Avalanche energy, single pulse<br>$I_D = 29\text{ A}$ , $V_{DD} = 25\text{ V}$ , $R_{GS} = 25\text{ }\Omega$<br>$L = 83\text{ }\mu\text{H}$ , $T_j = 25\text{ °C}$ | $E_{AS}$    | 70       | mJ                |
| Reverse diode $dv/dt$<br>$I_S = 29\text{ A}$ , $V_{DS} = 40\text{ V}$ , $di_F/dt = 200\text{ A}/\mu\text{s}$<br>$T_{jmax} = 175\text{ °C}$                         | $dv/dt$     | 6        | kV/ $\mu\text{s}$ |
| Gate source voltage  | $V_{GS}$    | $\pm 14$ | V                 |
| Gate-source peak voltage, aperiodic  | $V_{gs}$    | $\pm 20$ | V                 |
| Power dissipation<br>$T_C = 25\text{ °C}$  | $P_{tot}$   | 100      | W                 |

## Maximum Ratings

| Parameter                           | Symbol     | Values        | Unit |
|-------------------------------------|------------|---------------|------|
| Operating temperature               | $T_j$      | -55 ... + 175 | °C   |
| Storage temperature                 | $T_{stg}$  | -55 ... + 175 |      |
| Thermal resistance, chip case       | $R_{thJC}$ | ≤ 1.5         | K/W  |
| Thermal resistance, chip to ambient | $R_{thJA}$ | ≤ 75          |      |
| DIN humidity category, DIN 40 040   |            | E             |      |
| IEC climatic category, DIN IEC 68-1 |            | 55 / 175 / 56 |      |

## Electrical Characteristics, at $T_j = 25^\circ\text{C}$ , unless otherwise specified

| Parameter | Symbol | Values |      |      | Unit |
|-----------|--------|--------|------|------|------|
|           |        | min.   | typ. | max. |      |

## Static Characteristics

|  |               |     |       |      |    |
|--|---------------|-----|-------|------|----|
| Drain- source breakdown voltage<br>$V_{GS} = 0 \text{ V}$ , $I_D = 0.25 \text{ mA}$ , $T_j = -40 \text{ }^\circ\text{C}$ | $V_{(BR)DSS}$ | 50  | -     | -    | V  |
| Gate threshold voltage<br>$V_{GS} = V_{DS}$ , $I_D = 1 \text{ mA}$   | $V_{GS(th)}$  | 1.2 | 1.6   | 2    |    |
| Zero gate voltage drain current<br>$V_{DS} = 50 \text{ V}$ , $V_{GS} = 0 \text{ V}$ , $T_j = 25 \text{ }^\circ\text{C}$  | $I_{DSS}$     | -   | 0.1   | 1    | μA |
| $V_{DS} = 50 \text{ V}$ , $V_{GS} = 0 \text{ V}$ , $T_j = -40 \text{ }^\circ\text{C}$                                    |               | -   | 1     | 100  | nA |
| $V_{DS} = 50 \text{ V}$ , $V_{GS} = 0 \text{ V}$ , $T_j = 150 \text{ }^\circ\text{C}$                                    |               | -   | 10    | 100  | μA |
| Gate-source leakage current<br>$V_{GS} = 20 \text{ V}$ , $V_{DS} = 0 \text{ V}$  | $I_{GSS}$     | -   | 10    | 100  | nA |
| Drain-Source on-resistance<br>$V_{GS} = 5 \text{ V}$ , $I_D = 14.5 \text{ A}$  | $R_{DS(on)}$  | -   | 0.045 | 0.06 | Ω  |

## Electrical Characteristics, at $T_j = 25^\circ\text{C}$ , unless otherwise specified

| Parameter   | Symbol       | Values |      |      | Unit |
|---|--------------|--------|------|------|------|
|   |              | min.   | typ. | max. |      |
| <b>Dynamic Characteristics</b>  |              |        |      |      |      |
| Transconductance<br>$V_{DS} \geq 2 * I_D * R_{DS(on)max}, I_D = 14.5 \text{ A}$                                 | $g_{fs}$     | 7      | 17   | -    | S    |
| Input capacitance<br>$V_{GS} = 0 \text{ V}, V_{DS} = 25 \text{ V}, f = 1 \text{ MHz}$                           | $C_{iss}$    | -      | 720  | 960  | pF   |
| Output capacitance<br>$V_{GS} = 0 \text{ V}, V_{DS} = 25 \text{ V}, f = 1 \text{ MHz}$                          | $C_{oss}$    | -      | 220  | 330  |      |
| Reverse transfer capacitance<br>$V_{GS} = 0 \text{ V}, V_{DS} = 25 \text{ V}, f = 1 \text{ MHz}$                | $C_{rss}$    | -      | 100  | 150  |      |
| Turn-on delay time<br>$V_{DD} = 30 \text{ V}, V_{GS} = 5 \text{ V}, I_D = 3 \text{ A}$<br>$R_{GS} = 50 \Omega$  | $t_{d(on)}$  | -      | 25   | 40   | ns   |
| Rise time<br>$V_{DD} = 30 \text{ V}, V_{GS} = 5 \text{ V}, I_D = 3 \text{ A}$<br>$R_{GS} = 50 \Omega$           | $t_r$        | -      | 95   | 140  |      |
| Turn-off delay time<br>$V_{DD} = 30 \text{ V}, V_{GS} = 5 \text{ V}, I_D = 3 \text{ A}$<br>$R_{GS} = 50 \Omega$ | $t_{d(off)}$ | -      | 140  | 190  |      |
| Fall time<br>$V_{DD} = 30 \text{ V}, V_{GS} = 5 \text{ V}, I_D = 3 \text{ A}$<br>$R_{GS} = 50 \Omega$           | $t_f$        | -      | 85   | 115  |      |

**Electrical Characteristics, at  $T_j = 25^\circ\text{C}$ , unless otherwise specified**

| Parameter   | Symbol   | Values |      |      | Unit          |
|---|----------|--------|------|------|---------------|
|   |          | min.   | typ. | max. |               |
| <b>Reverse Diode</b>  |          |        |      |      |               |
| Inverse diode continuous forward current<br>$T_C = 25^\circ\text{C}$                          | $I_S$    | -      | -    | 29   | A             |
| Inverse diode direct current, pulsed<br>$T_C = 25^\circ\text{C}$                              | $I_{SM}$ | -      | -    | 116  |               |
| Inverse diode forward voltage<br>$V_{GS} = 0\text{ V}, I_F = 58\text{ A}$                     | $V_{SD}$ | -      | 1.2  | 2    | V             |
| Reverse recovery time<br>$V_R = 30\text{ V}, I_F = I_S, di_F/dt = 100\text{ A}/\mu\text{s}$   | $t_{rr}$ | -      | 50   | -    | ns            |
| Reverse recovery charge<br>$V_R = 30\text{ V}, I_F = I_S, di_F/dt = 100\text{ A}/\mu\text{s}$ | $Q_{rr}$ | -      | 70   | -    | $\mu\text{C}$ |

### Power dissipation

$$P_{\text{tot}} = f(T_C)$$

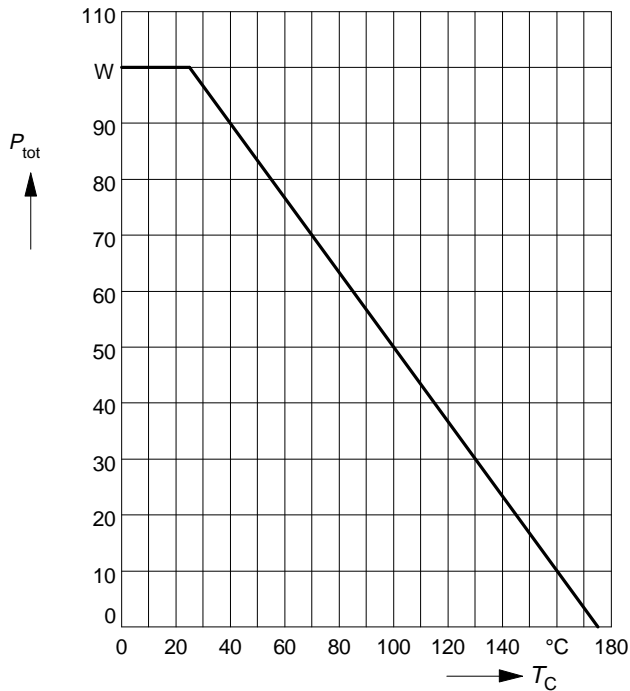

### Drain current

$$I_D = f(T_C)$$

parameter:  $V_{GS} \geq 5 \text{ V}$

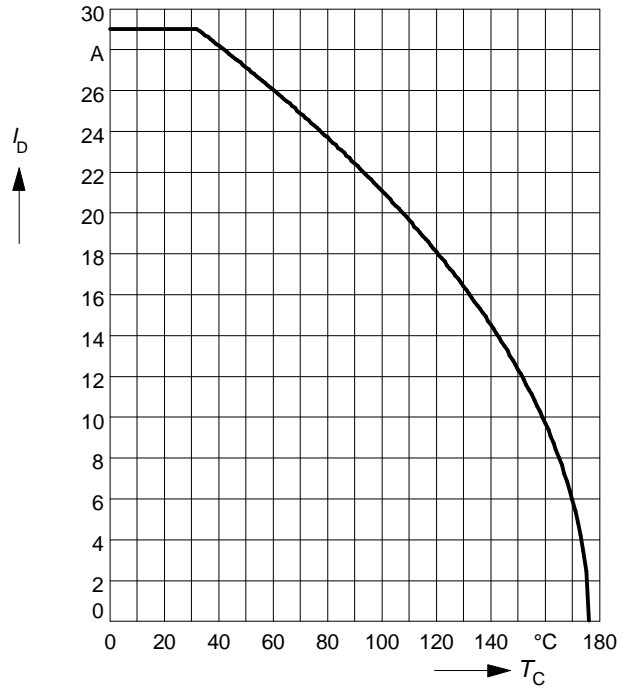

### Safe operating area

$$I_D = f(V_{DS})$$

parameter:  $D = 0.01$ ,  $T_C = 25^\circ\text{C}$

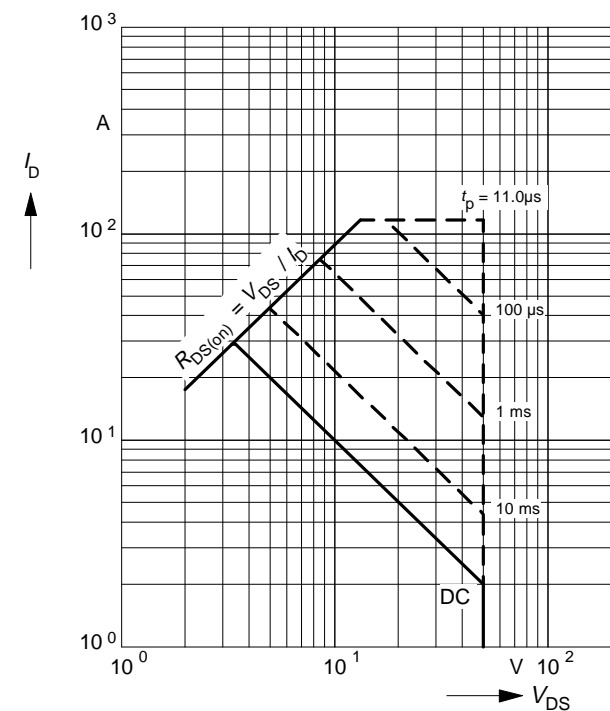

### Transient thermal impedance

$$Z_{\text{thJC}} = f(t_p)$$

parameter:  $D = t_p / T$

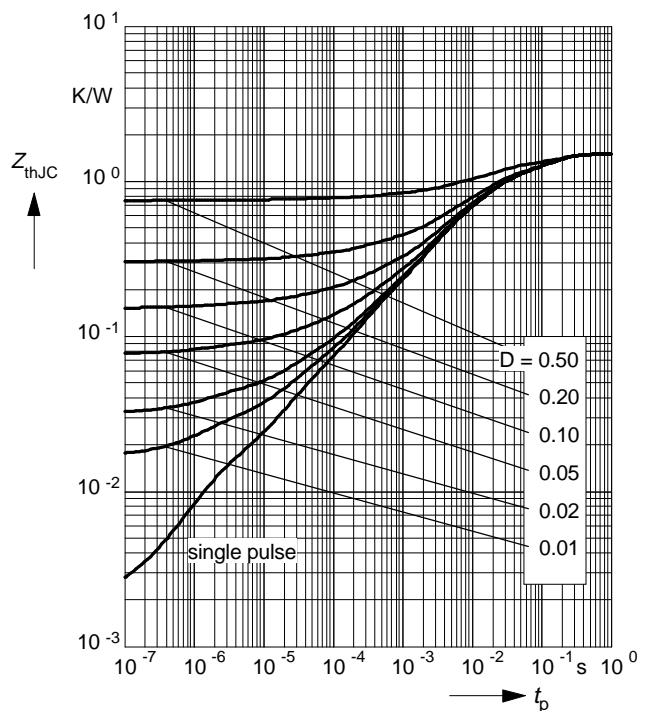

### Typ. output characteristics

$$I_D = f(V_{DS})$$

parameter:  $t_p = 80 \mu s$

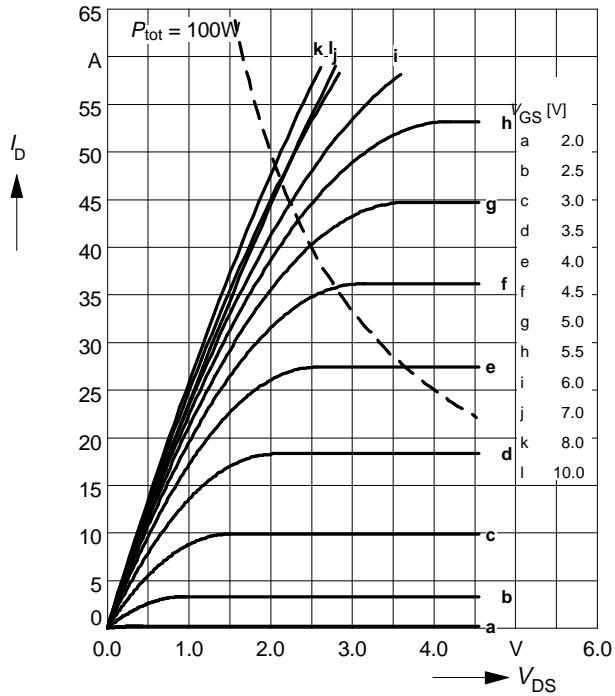

### Drain-source on-resistance

$$R_{DS(on)} = f(T_j)$$

parameter:  $I_D = 14.5 A, V_{GS} = 5 V$

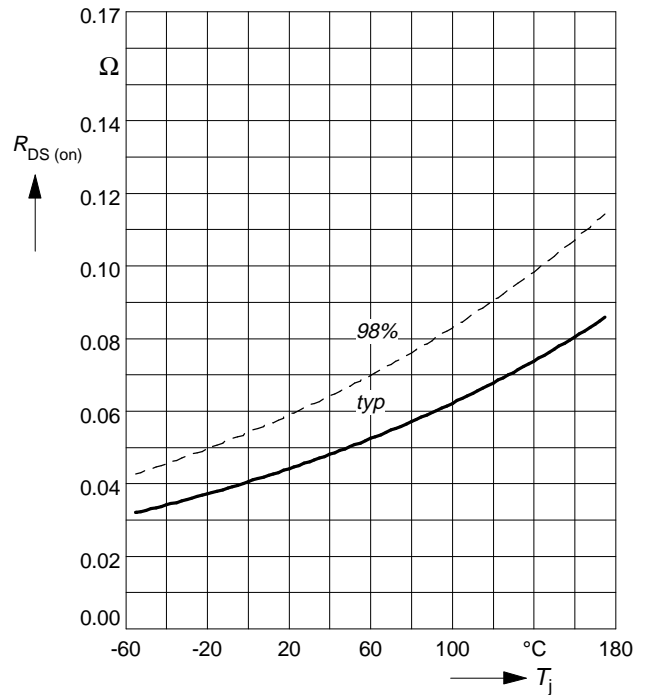

### Typ. transfer characteristics $I_D = f(V_{GS})$

parameter:  $t_p = 80 \mu s$

$$V_{DS} \geq 2 \times I_D \times R_{DS(on)max}$$

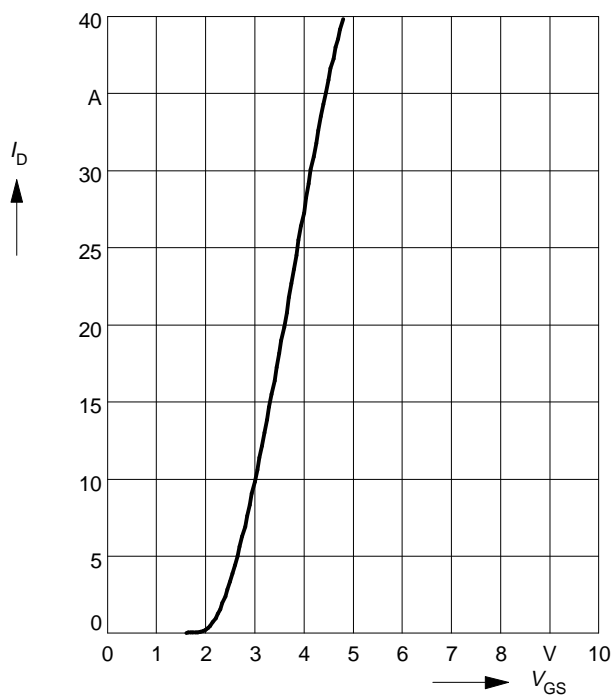

### Typ. forward transconductance $g_{fs} = f(I_D)$

parameter:  $t_p = 80 \mu s,$

$$V_{DS} \geq 2 \times I_D \times R_{DS(on)max}$$

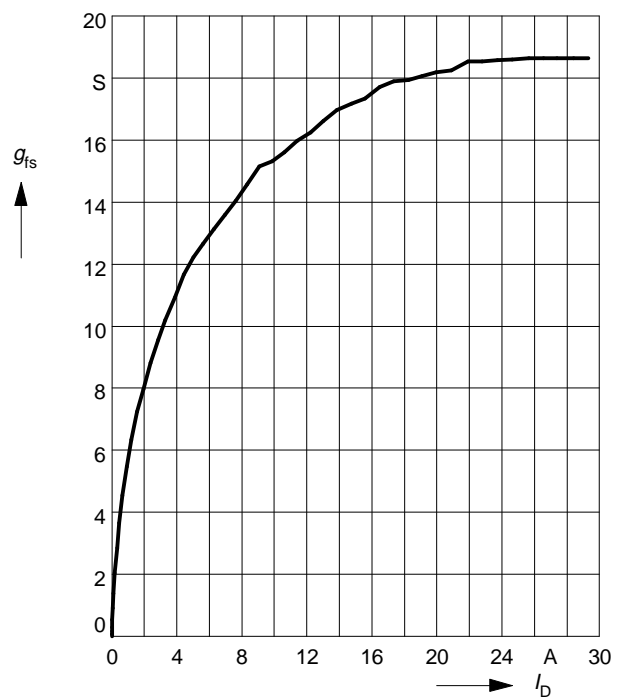

### Typ. drain-source on-resistance

$R_{DS(on)} = f(I_D)$   
parameter:  $V_{GS}$

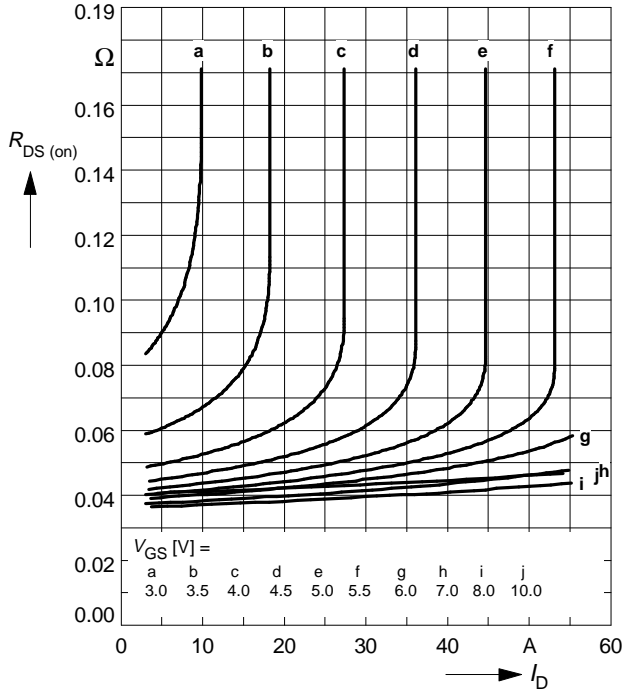

### Gate threshold voltage

$V_{GS(th)} = f(T_j)$   
parameter:  $V_{GS} = V_{DS}, I_D = 1 \text{ mA}$

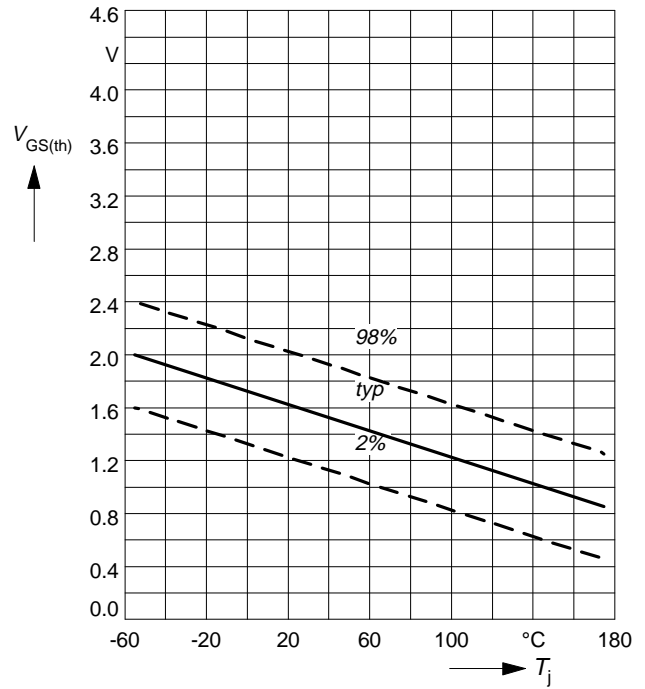

### Typ. capacitances

$C = f(V_{DS})$   
parameter:  $V_{GS} = 0\text{V}, f = 1\text{MHz}$

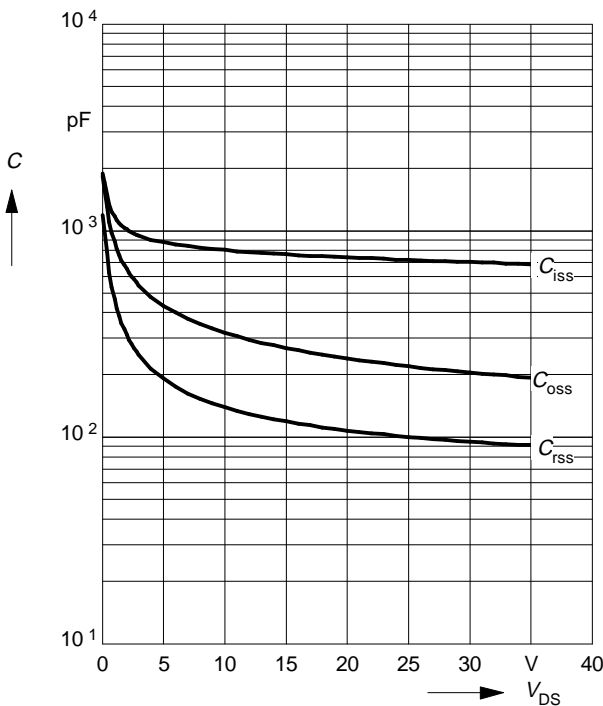

### Forward characteristics of reverse diode

$I_F = f(V_{SD})$   
parameter:  $T_j, t_p = 80 \mu\text{s}$

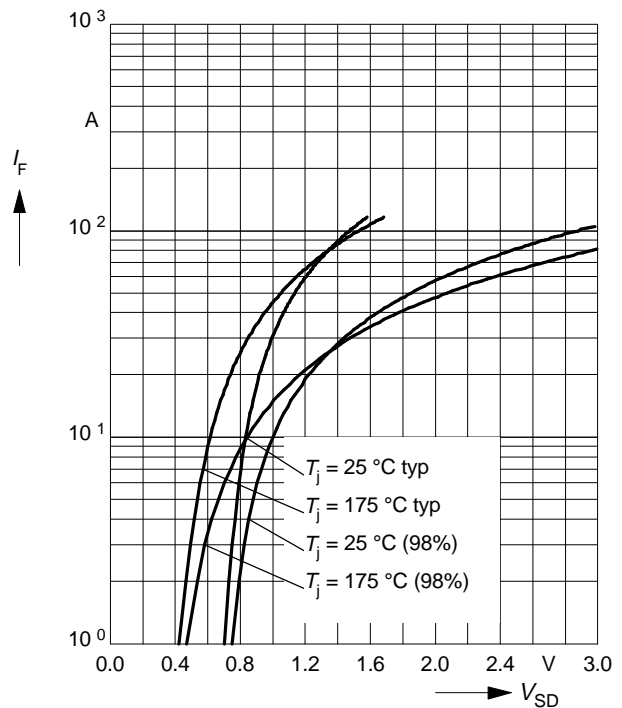

### Avalanche energy $E_{AS} = f(T_j)$

parameter:  $I_D = 29 \text{ A}$ ,  $V_{DD} = 25 \text{ V}$

$R_{GS} = 25 \Omega$ ,  $L = 83 \mu\text{H}$

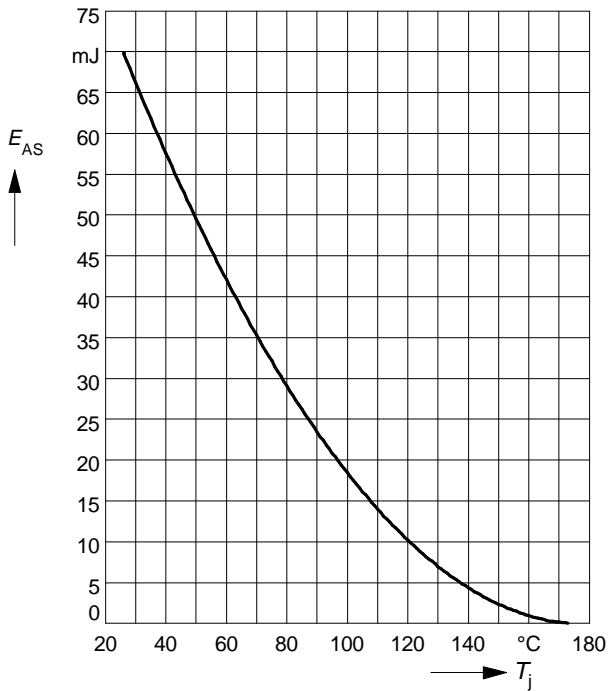

### Typ. gate charge

$V_{GS} = f(Q_{\text{Gate}})$

parameter:  $I_{D \text{ puls}} = 44 \text{ A}$

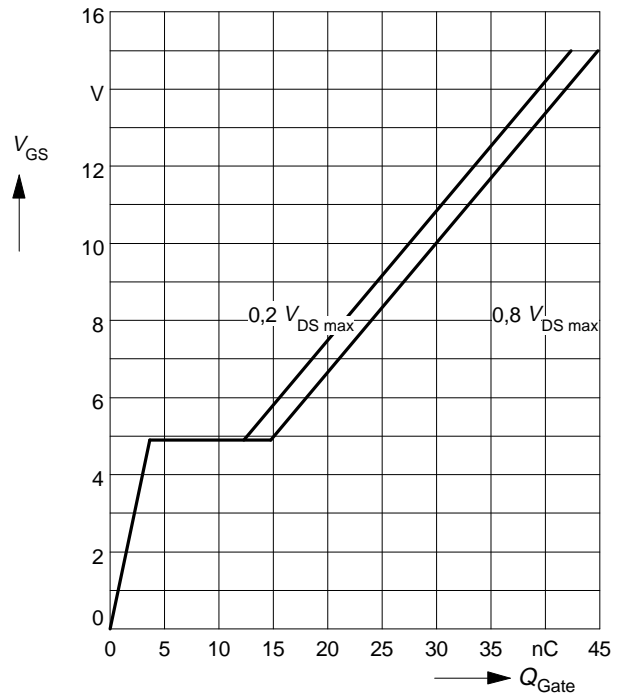

### Drain-source breakdown voltage

$V_{(BR)DSS} = f(T_j)$

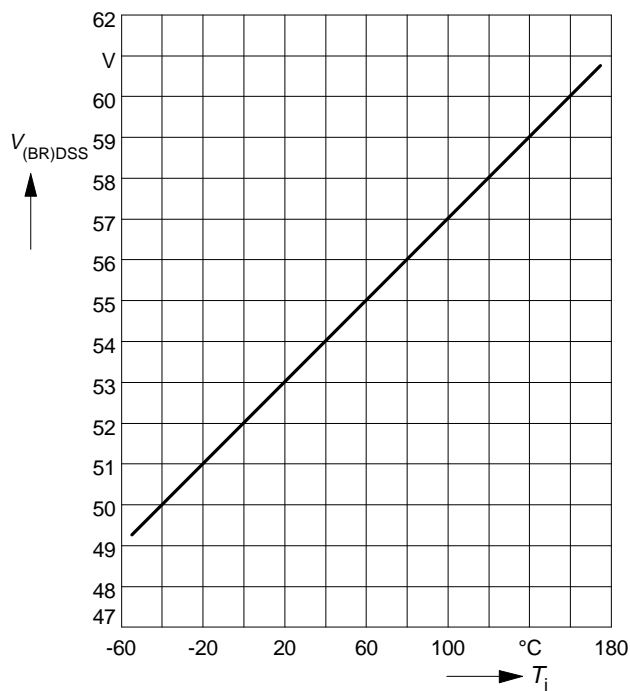



### Package Outlines

TO-220 AB

Dimension in mm

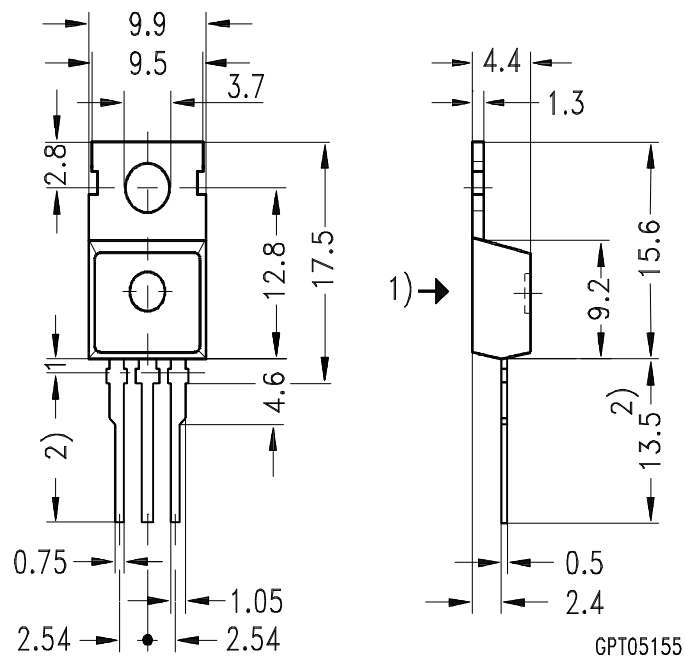

- 1) punch direction, burr max. 0.04
- 2) dip tinning
- 3) max. 14.5 by dip tinning press burr max. 0.05