

## IL215A/216A/217A PHOTOTRANSISTOR SMALL OUTLINE SURFACE MOUNT OPTOCOUPLER

- **FEATURES**
- **High Current Transfer Ratio,  $I_F=1$  mA**  
 IL215A—20% Minimum  
 IL216A—50% Minimum  
 IL217A—100% Minimum
- **Isolation Voltage, 2500 VAC<sub>RMS</sub>**
- **Electrical Specifications Similar to Standard 6 Pin Coupler**
- **Industry Standard SOIC-8 Surface Mountable Package**
- **Standard Lead Spacing, .05"**
- **Available in Tape and Reel Option (Conforms to EIA Standard RS481A)**
- **Compatible with Dual Wave, Vapor Phase and IR Reflow Soldering**
- **Underwriters Lab File #E52744 (Code Letter P)**

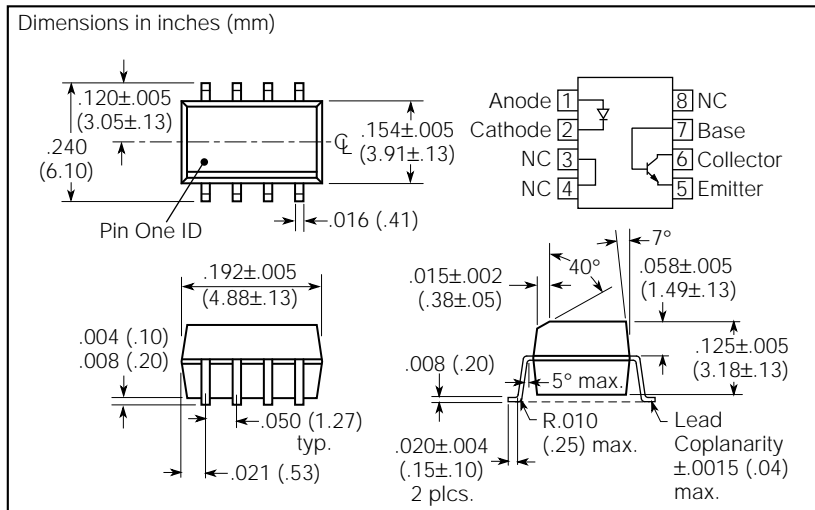

### DESCRIPTION

The IL215A/216A/217A are optically coupled pairs with a Gallium Arsenide infrared LED and a silicon NPN phototransistor. Signal information, including a DC level, can be transmitted by the device while maintaining a high degree of electrical isolation between input and output. The IL215A/216A/217A comes in a standard SOIC-8 small outline package for surface mounting which makes it ideally suited for high density applications with limited space. In addition to eliminating through-holes requirements, this package conforms to standards for surface mounted devices.

The high CTR at low input current is designed for low power consumption requirements such as CMOS microprocessor interfaces.

### Maximum Ratings

#### Emitter

Peak Reverse Voltage .....6.0 V  
 Continuous Forward Current ..... 60 mA  
 Power Dissipation at 25°C .....90 mW  
 Derate Linearly from 25°C .....1.2 mW/°C

#### Detector

Collector-Emitter Breakdown Voltage .....30 V  
 Emitter-Collector Breakdown Voltage .....7 V  
 Collector-Base Breakdown Voltage .....70 V  
 Power Dissipation .....150 mW  
 Derate Linearly from 25°C .....2.0 mW/°C

#### Package

Total Package Dissipation at 25°C Ambient (LED + Detector) .....280 mW  
 Derate Linearly from 25°C .....3.3 mW/°C  
 Storage Temperature ..... -55°C to +150°C  
 Operating Temperature ..... -55°C to +100°C  
 Soldering Time at 260°C ..... 10 sec.

### Characteristics ( $T_A=25^\circ\text{C}$ )

	Symbol	Min.	Typ.	Max.	Unit	Condition
<b>Emitter</b>						
Forward Voltage	$V_F$		1.0	1.5	V	$I_F=1$ mA
Reverse Current	$I_R$		0.1	100	$\mu\text{A}$	$V_R=6.0$ V
Capacitance	$C_O$		25		pF	$V_R=0$
<b>Detector</b>						
Breakdown Voltage Collector-Emitter Emitter-Collector	$B_{V_{CE0}}$ $B_{V_{EC0}}$		30 7		V V	$I_C=10$ $\mu\text{A}$ $I_E=10$ $\mu\text{A}$
Dark Current, Collector-Emitter	$I_{CE0\text{dark}}$		5	50	nA	$V_{CE}=10$ V $I_F=0$
Capacitance, Collector-Emitter	$C_{CE}$		10		pF	$V_{CE}=0$
<b>Package</b>						
DC Current Transfer Ratio IL215A IL216A IL217A	$CTR_{DC}$		20 50 100	50 80 130	%	$I_F=10$ mA, $V_{CE}=5$ V
Saturation Voltage, Collector-Emitter	$V_{CE\text{sat}}$			0.5		$I_F=1$ mA, $I_C=0.1$ mA
Isolation Test Voltage	$V_{IO}$	2500			VAC <sub>RMS</sub>	
Capacitance, Input to Output	$C_{IO}$		0.5		pF	
Resistance, Input to Output	$R_{IO}$		100		G $\Omega$	
Switching Time	$t_{on}, t_{off}$		3.0		$\mu\text{s}$	$I_C=2$ mA, $R_E=100$ $\Omega$ , $V_{CE}=10$ V

Figure 1. Forward voltage versus forward current

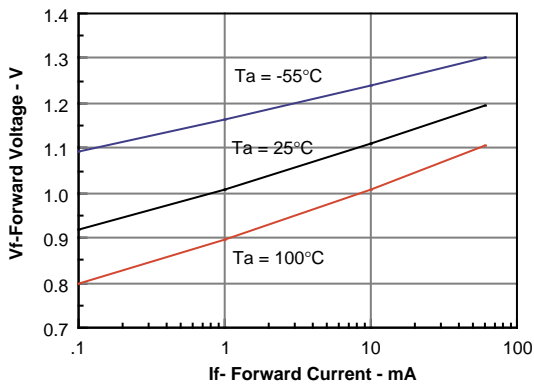

Figure 5. Collector-base photocurrent versus LED current

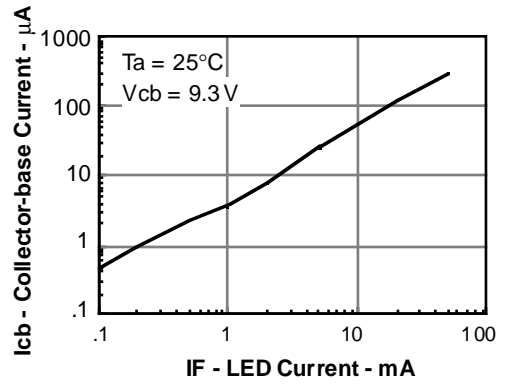

Figure 2. Normalized non-saturated and saturated CTRce versus LED current

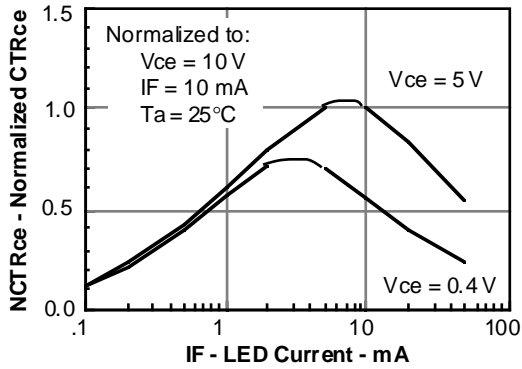

Figure 6. Collector-emitter leakage current versus temperature

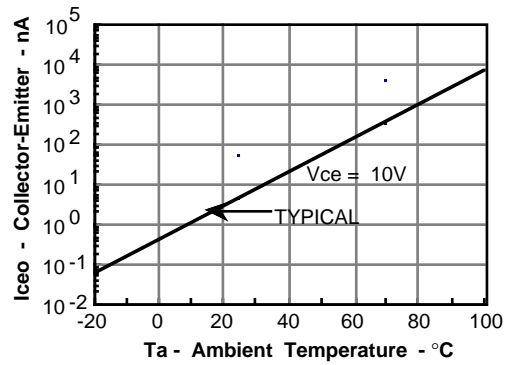

Figure 3. Collector-emitter current versus LED current

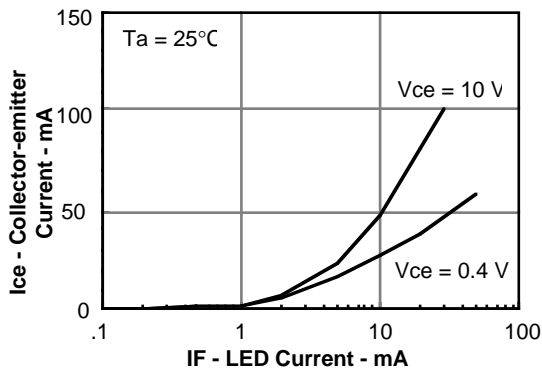

Figure 7. Normalized saturated HFE versus base current and temperature

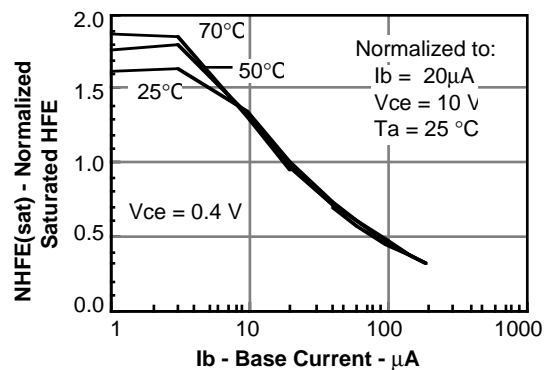

Figure 4. Normalized collector-base photocurrent versus LED current

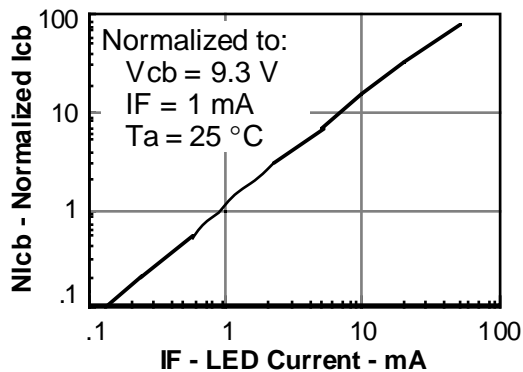
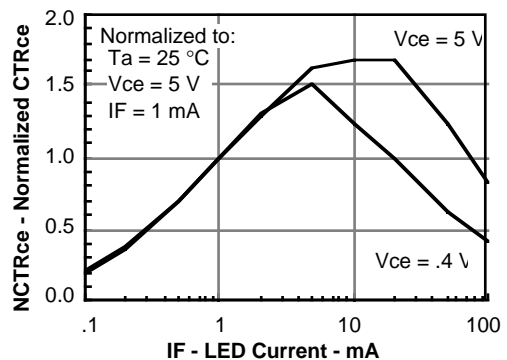
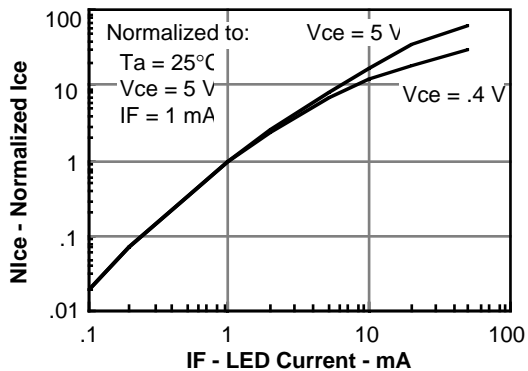

Figure 8. Normalized non-saturated and saturated CTRce versus LED current



**Figure 9. Normalized non-saturated and saturated collector-emitter current versus LED current**



**Figure 10. Normalized collector-base photocurrent versus LED current**

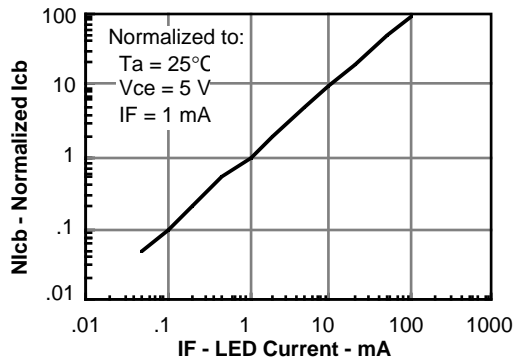

**Figure 11. Collector-base photocurrent versus LED current**

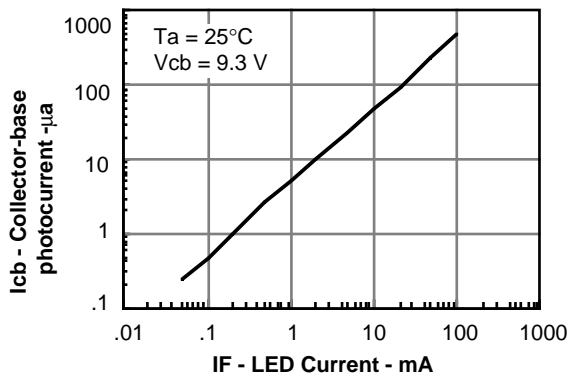

**Figure 12. High to low propagation delay versus LED current and load resistor**

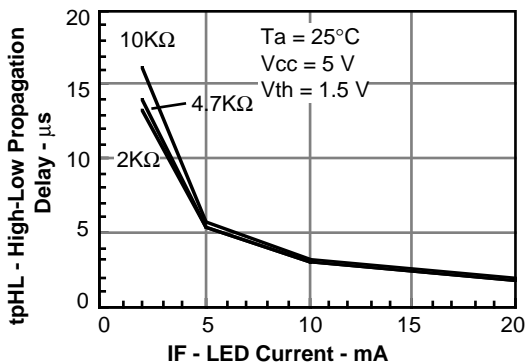

**Figure 13. Low to high propagation delay versus LED current and load resistor**

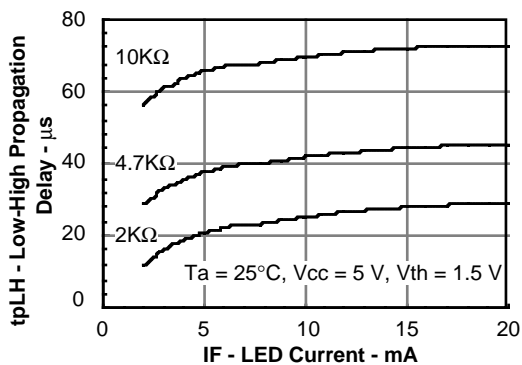

**Figure 14. Normalized non-saturated HFE versus base current and temperature**

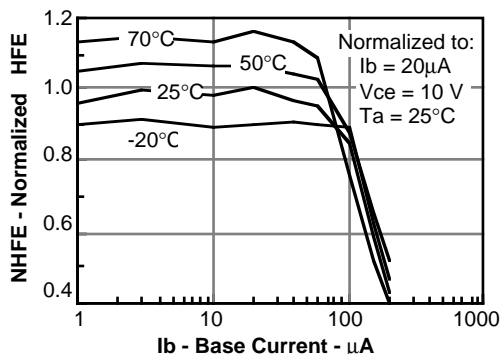

**Figure 15. Typical switching characteristics versus base resistance (saturated operation)**

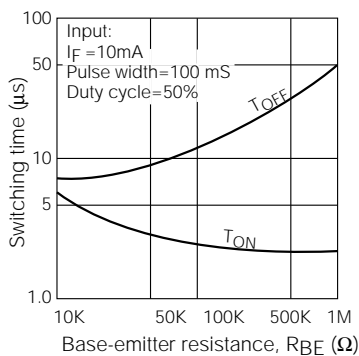

**Figure 16. Typical switching times versus load resistance**

