

FEATURES

- **Very High Current Transfer Ratio (500% min.)**
IL755B-1: 750% at $I_F=2\text{ mA}$, $V_{CE}=5\text{ V}$
IL755B-2: 1000% at $I_F=1\text{ mA}$, $V_{CE}=5\text{ V}$
- **$BV_{CEO} > 60\text{ V}$**
- **Isolation Test Voltage, 5300 VAC_{RMS}**
- **AC or Polarity Insensitive Inputs**
- **No Base Connection**
- **High Isolation Resistance, $10^{12}\Omega$**
- **Low Coupling Capacitance**
- **Standard Plastic DIP Package**
- **Underwriters Lab Approval #E52744**
- **VDE #0884 Available with Option 1**

DESCRIPTION

The IL755B is a bidirectional input, optically coupled isolator consisting of two Gallium Arsenide infrared emitters and a silicon photodarlington sensor.

Maximum Ratings (at 25°C)

Emitter (Drive Circuit)

Continuous Forward Current 60 mA
Power Dissipation at 25°C 100 mW
Derate Linearly from 55°C 1.33 mW/°C

Detector

Collector-Emitter Breakdown Voltage 60 V
Emitter-Collector Breakdown Voltage 12 V
Power Dissipation at 25°C Ambient 200 mW
Derate Linearly from 25°C 2.6 mW/°C

Package

Isolation Test Voltage
(PK), $t=1\text{ sec.}$ 5300 VAC_{RMS}
Dissipation at 25°C 250 mW
Derate Linearly from 25°C⁽²⁾ 3.3 mW/°C
Creepage 7 min mm
Clearance 7 min mm
Isolation Resistance
 $T_A=25^\circ\text{C.}$ $\geq 10^{12}\Omega$
 $T_A=100^\circ\text{C.}$ $\geq 10^{11}\Omega$
Storage Temperature⁽²⁾ -55°C to +150°C
Operating Temperature -55°C to +100°C
Lead Soldering Time at 260°C 10 sec.

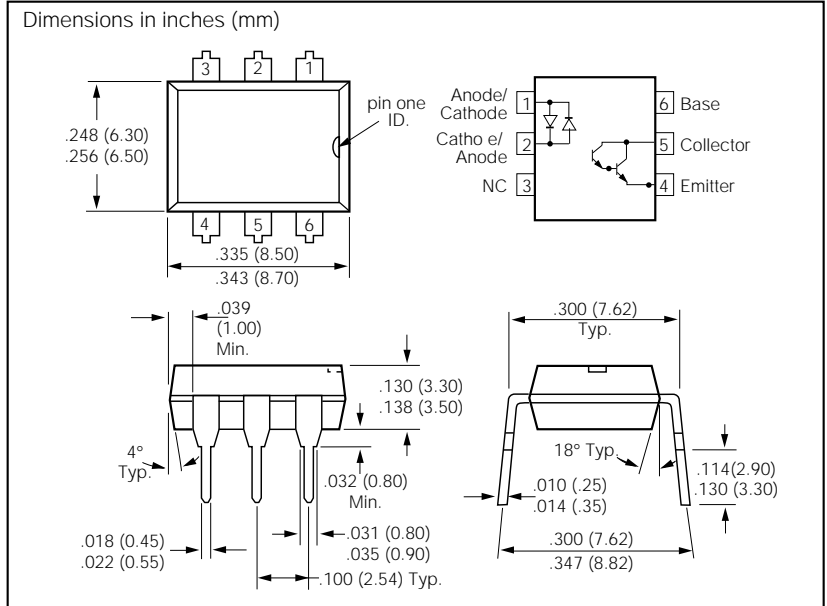

Electrical Characteristics ($T_A=25^\circ\text{C}$)

	Symbol	Min.	Typ.	Max.	Unit	Condition
Emitter						
Forward Voltage ⁽¹⁾	V_F		1.25	1.5	V	$I_F=10\text{ mA}$
Detector⁽²⁾						
Breakdown Voltage, Collector-Emitter	BV_{CEO}	60	75		V	$I_C=1\text{ mA}$, $I_F=0$
Leakage Current, Collector-Emitter	I_{CEO}		1.0	100	nA	$V_{CE}=10\text{ V}$, $I_F=0$
Package						
Current Transfer Ratio ⁽²⁾	CTR				%	
IL755B-1		750			%	$I_F=\pm 2\text{ mA}$, $V_{CE}=5\text{ V}$
IL755B-2		1000			%	$I_F=\pm 1\text{ mA}$, $V_{CE}=5\text{ V}$
Saturation Voltage, Collector-Emitter	V_{CEsat}			1.0	V	$I_C=10\text{ mA}$, $I_F=\pm 10\text{ mA}$
Turn-On Time	t_{on}			200	μs	$V_{CC}=10\text{ V}$
Turn-Off Time	t_{off}			200	μs	$I_F=\pm 2\text{ mA}$, $R_L=100\Omega$

Notes:

1. Indicates JEDEC registered data.

Figure 1. LED forward current versus forward voltage

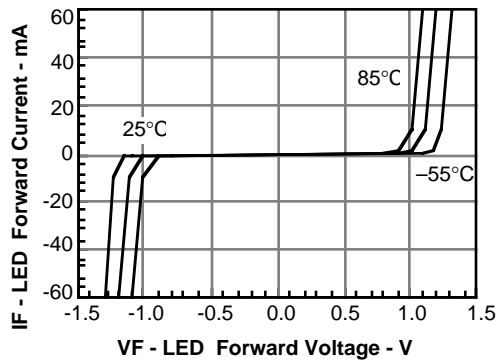

Figure 2. Normalized non-saturated and saturated CTRce versus LED current

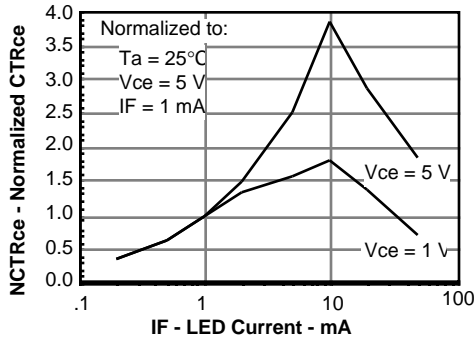

Figure 3. Normalized non-saturated and saturated CTRce versus LED current

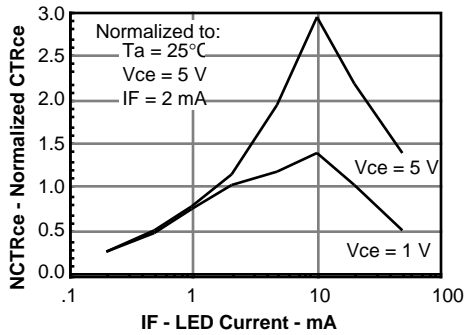

Figure 4. Normalized non-saturated and saturated Ice versus LED current

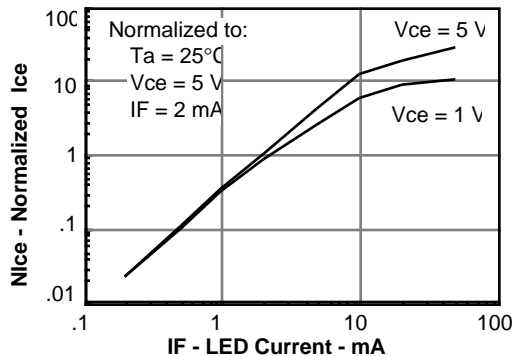

Figure 5. Normalized non-saturated and saturated collector-emitter current versus LED current

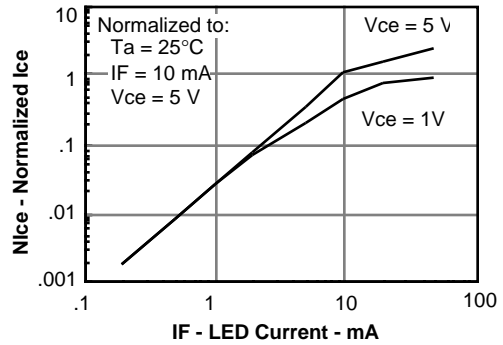

Figure 6. Low to high propagation delay versus collector load resistance and LED current

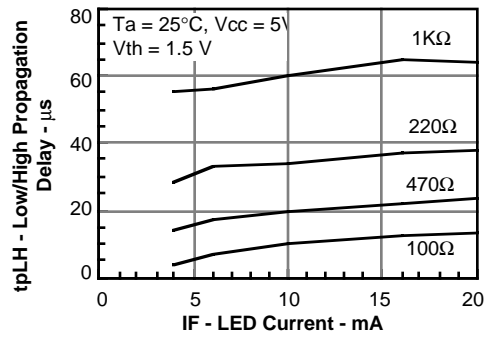

Figure 7. High to low propagation delay versus collector load resistance and LED current

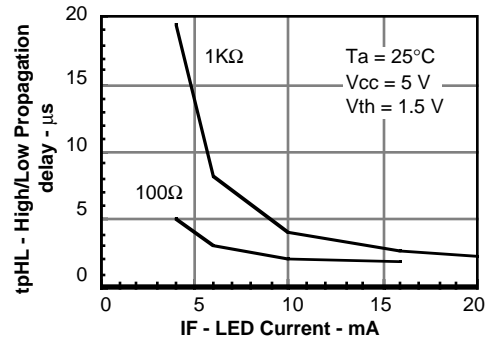

Figure 8. Switching waveform

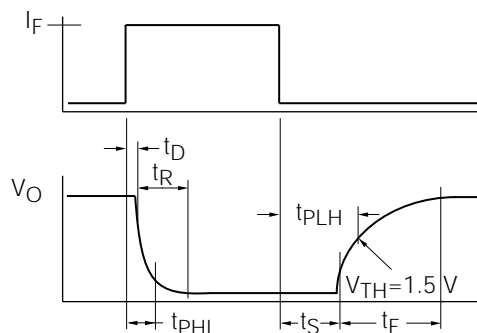

Figure 9. Normalized non-saturated and saturated CTRce versus LED current

