

### Besondere Merkmale

- Gehäusebauform: P-LCC-4
- Gehäusefarbe: weiß
- als optischer Indikator einsetzbar
- zur Hinterleuchtung, Lichtleiter- und Linseneinkopplung
- beide Leuchtdiodenchips getrennt ansteuerbar
- hohe Signalwirkung durch Farbwechsel der LED möglich
- bei geeigneter Ansteuerung, Farbwechsel von grün über gelb und orange bis super-rot möglich
- für alle SMT-Bestück- und Löttechniken geeignet
- gegurtet (12-mm-Filmgurt)
- Störimpulsfest nach DIN 40839

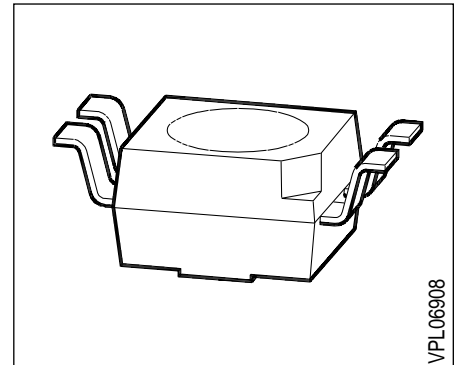

### Features

- P-LCC-4 package
- color of package: white
- for use as optical indicator
- for backlighting, optical coupling into light pipes and lenses
- both chips can be controlled separately
- high signal efficiency possible by color change of the LED
- with appropriate controlling it is possible to change color from green to yellow and orange to super-red
- suitable for all SMT assembly and soldering methods
- available taped on reel (12 mm tape)
- load dump resistant acc. to DIN 40839

Typ	Emissions- farbe	Farbe der Lichtaustritts- fläche	Lichtstärke	Lichtstrom	Bestellnummer
Type	Color of Emission	Color of the Light Emitting Area	Luminous Intensity $I_F = 10 \text{ mA}$ $I_V(\text{mcd})$	Luminous Flux $I_F = 10 \text{ mA}$ $\Phi_V(\text{mlm})$	Ordering Code
LSG T770-HK	super-red /	colorless clear	2.5 ... 12.5	-	Q62703-Q2567
LSG T770-J	green		4.0 ... 8.0	18 (typ.)	Q62703-Q2893
LSG T770-K			6.3 ... 12.5	30 (typ.)	Q62703-Q2894
LSG T770-JL			4.0 ... 20.0	-	Q62703-Q2895

Streuung der Lichtstärke in einer Verpackungseinheit  $I_{V \max} / I_{V \min} \leq 2.0$ .<sup>1)</sup>

Streuung der Lichtstärke in einer LED  $I_{V \max} / I_{V \min} \leq 3.0$ .

<sup>1)</sup> Bei MULTILED® bestimmt die Helligkeit des jeweils dunkleren Chips in einem Gehäuse die Helligkeitsgruppe der LED.

Luminous intensity ratio in one packaging unit  $I_{V \max} / I_{V \min} \leq 2.0$ .<sup>1)</sup>

Luminous intensity ratio in one LED  $I_{V \max} / I_{V \min} \leq 3.0$ .

<sup>1)</sup> In case of MULTILED®, the brightness of the darker chip in one package determines the brightness group of the LED.

## Grenzwerte Maximum Ratings

Bezeichnung Parameter	Symbol Symbol	Wert Value	Einheit Unit
Betriebstemperatur Operating temperature range	$T_{op}$	- 55 ... + 100	°C
Lagertemperatur Storage temperature range	$T_{stg}$	- 55 ... + 100	°C
Sperrschichttemperatur Junction temperature	$T_j$	+ 100	°C
Durchlaßstrom Forward current	$I_F$	30	mA
Stoßstrom Surge current $t \leq 10 \mu s, D = 0.005$	$I_{FM}$	0.5	A
Sperrspannung Reverse voltage	$V_R$	5	V
Verlustleistung Power dissipation	$P_{tot}$	100	mW
Wärmewiderstand Thermal resistance Sperrschicht / Umgebung Junction / air Montage auf PC-Board*) (Padgröße $\geq 16 \text{ mm}^2$ ) mounted on PC board*) (pad size $\geq 16 \text{ mm}^2$ )	$R_{th JA}^{1)}$ $R_{th JA}^{2)}$	480 650	K/W K/W

\*) PC-board: FR4

1) nur ein Chip betrieben

1) one system only

2) beide Chips betrieben

2) both systems on simultaneously

## Notes

Die angegebenen Grenzdaten gelten für einen Chip.

The stated maximum ratings refer to one chip.

## Kennwerte ( $T_A = 25\text{ °C}$ )

### Characteristics

Bezeichnung Parameter	Symbol Symbol	Wert Value		Einheit Unit
		LS	LG	
Wellenlänge des emittierten Lichtes (typ.) Wavelength at peak emission (typ.) $I_F = 10\text{ mA}$	$\lambda_{\text{peak}}$	635	565	nm
Dominantwellenlänge (typ.) Dominant wavelength (typ.) $I_F = 10\text{ mA}$	$\lambda_{\text{dom}}$	628	570	nm
Spektrale Bandbreite bei 50 % $I_{\text{rel max}}$ (typ.) Spectral bandwidth at 50 % $I_{\text{rel max}}$ (typ.) $I_F = 10\text{ mA}$	$\Delta\lambda$	45	25	nm
Abstrahlwinkel bei 50 % $I_V$ (Vollwinkel) Viewing angle at 50 % $I_V$	$2\phi$	120	120	Grad deg.
Durchlaßspannung (typ.) Forward voltage (max.) $I_F = 10\text{ mA}$	$V_F$ $V_F$	2.0 2.6	2.0 2.6	V V
Sperrstrom (typ.) Reverse current (max.) $V_R = 5\text{ V}$	$I_R$ $I_R$	0.01 10	0.01 10	$\mu\text{A}$ $\mu\text{A}$
Kapazität (typ.) Capacitance $V_R = 0\text{ V}, f = 1\text{ MHz}$	$C_0$	12	15	pF
Schaltzeiten: Switching times: $I_V$ from 10 % to 90 % (typ.) $I_V$ from 90 % to 10 % (typ.) $I_F = 100\text{ mA}, t_p = 10\text{ }\mu\text{s}, R_L = 50\text{ }\Omega$	$t_r$ $t_f$	300 150	450 200	ns ns

Relative spektrale Emission  $I_{rel} = f(\lambda)$ ,  $T_A = 25\text{ }^\circ\text{C}$ ,  $I_F = 10\text{ mA}$

### Relative spectral emission

$V(\lambda)$  = spektrale Augenempfindlichkeit

Standard eye response curve

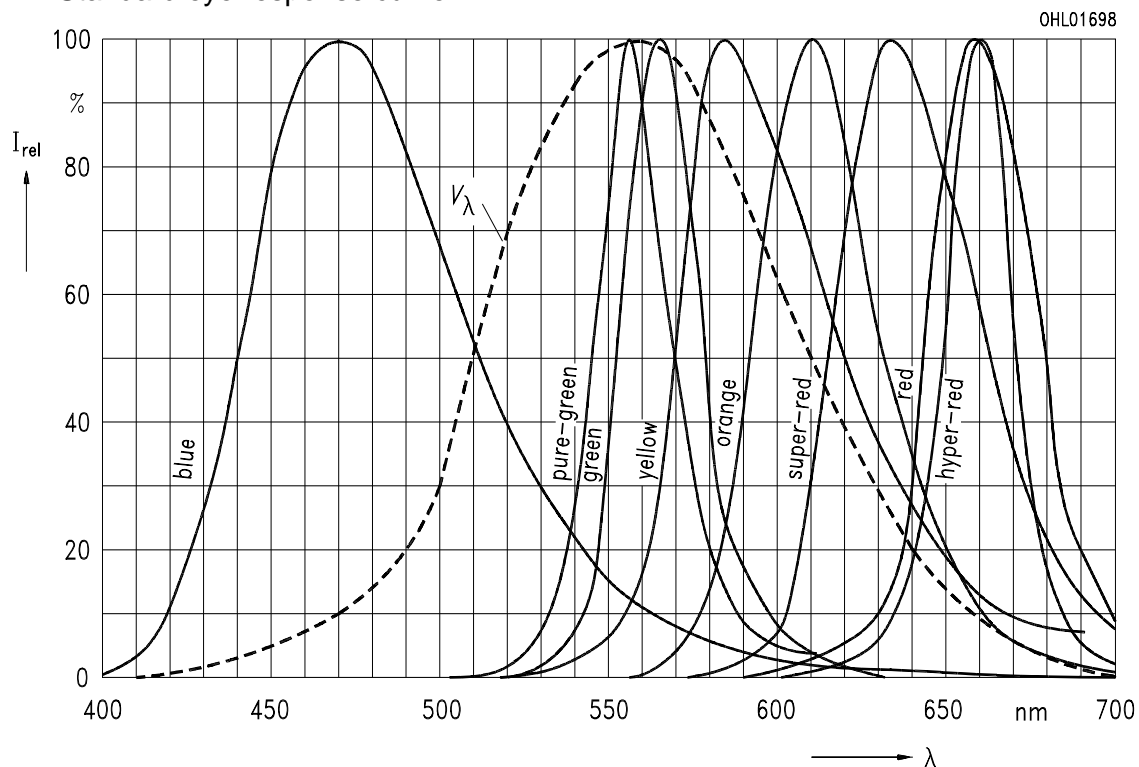

Abstrahlcharakteristik  $I_{rel} = f(\varphi)$

### Radiation characteristic

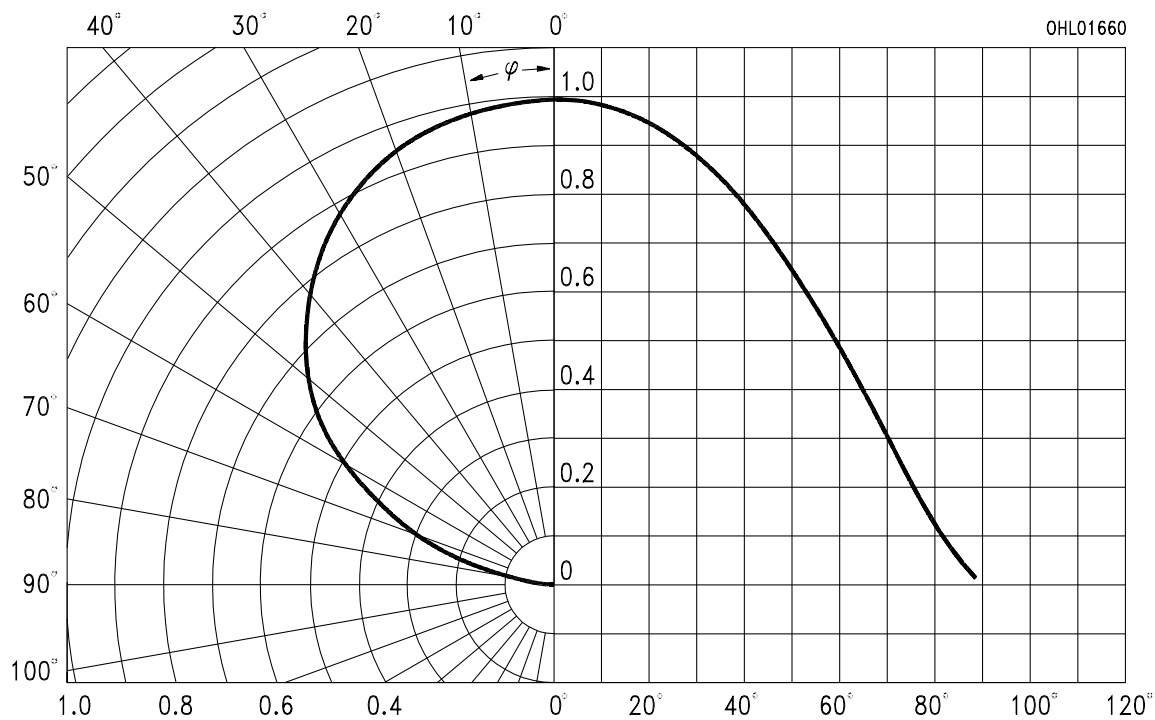

### Durchlaßstrom $I_F = f(V_F)$

#### Forward current

$T_A = 25^\circ\text{C}$

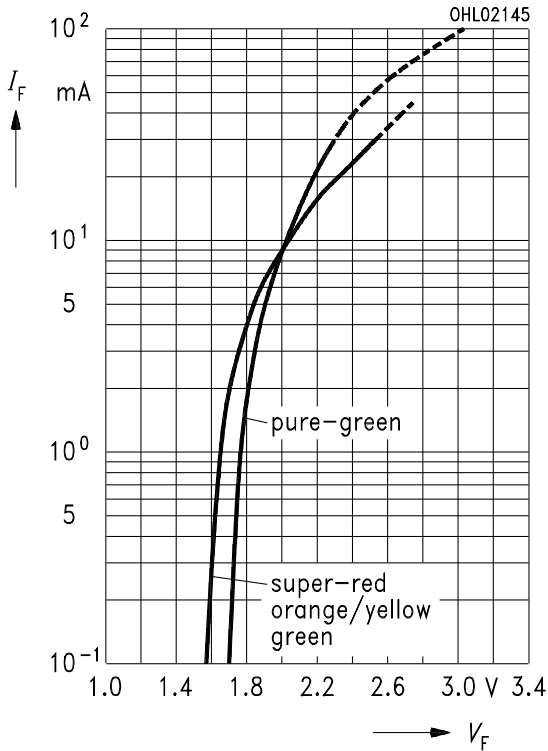

### Relative Lichtstärke $I_V / I_{V(10\text{ mA})} = f(I_F)$

#### Relative luminous intensity

$T_A = 25^\circ\text{C}$

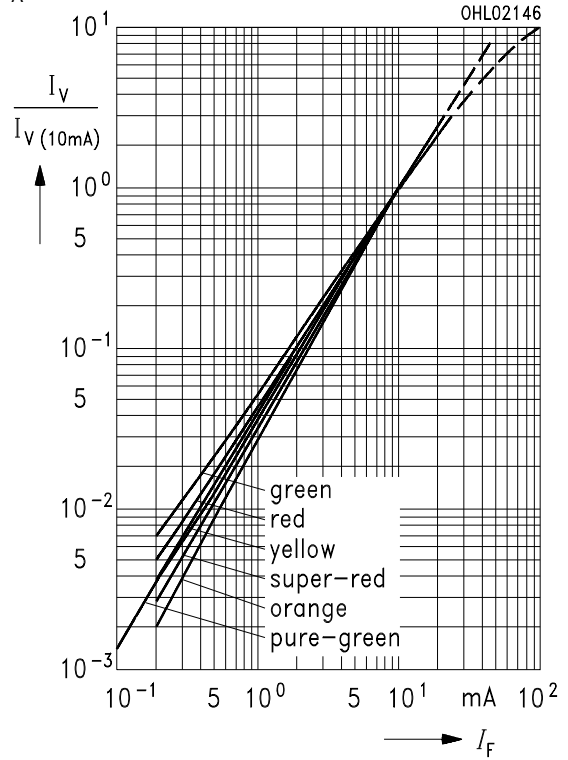

### Zulässige Impulsbelastbarkeit $I_F = f(t_p)$

#### Permissible pulse handling capability

Duty cycle  $D = \text{parameter}$ ,  $T_A = 25^\circ\text{C}$

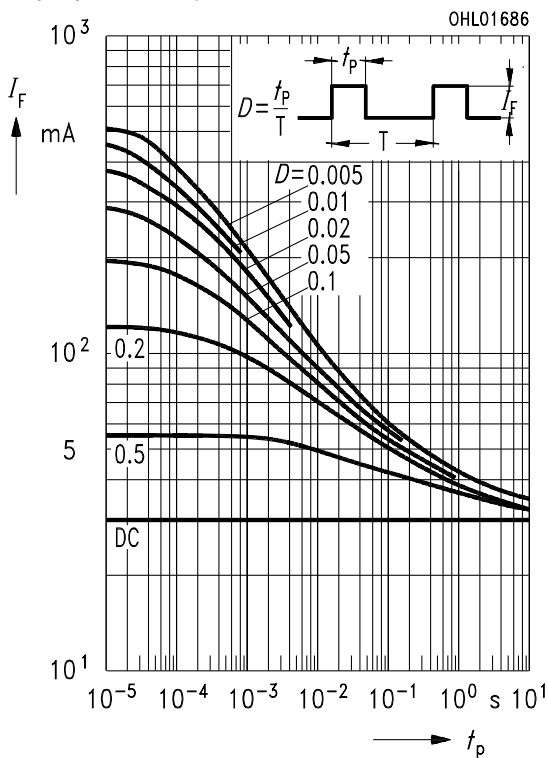

### Maximal zulässiger Durchlaßstrom $I_F = f(T_A)$

#### Max. permissible forward current

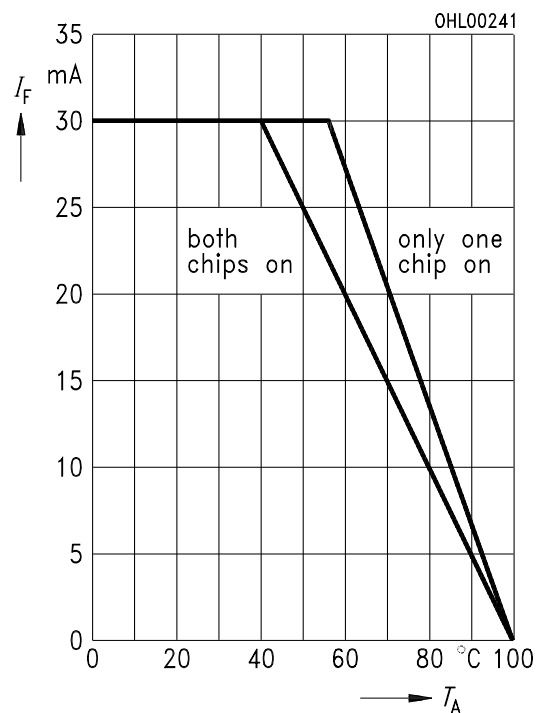

**Wellenlänge der Stahlung  $\lambda_{\text{peak}} = f(T_A)$**   
**Wavelength at peak emission**

$I_F = 10 \text{ mA}$

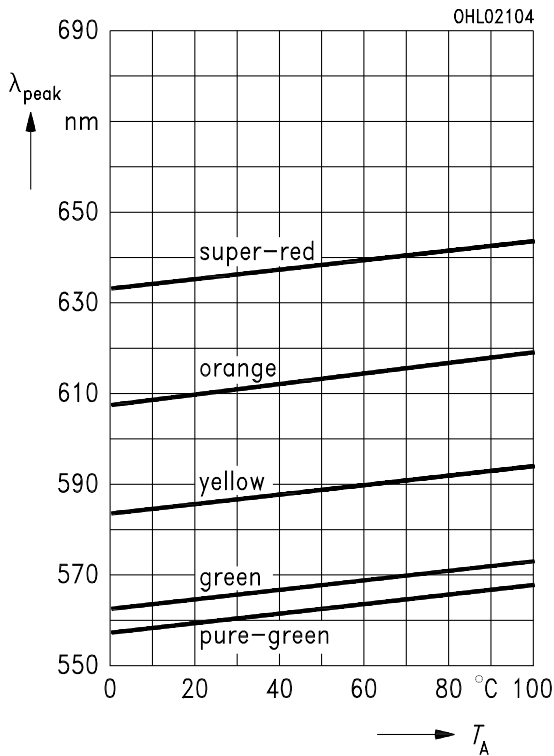

**Dominantwellenlänge  $\lambda_{\text{dom}} = f(T_A)$**   
**Dominant wavelength**

$I_F = 10 \text{ mA}$

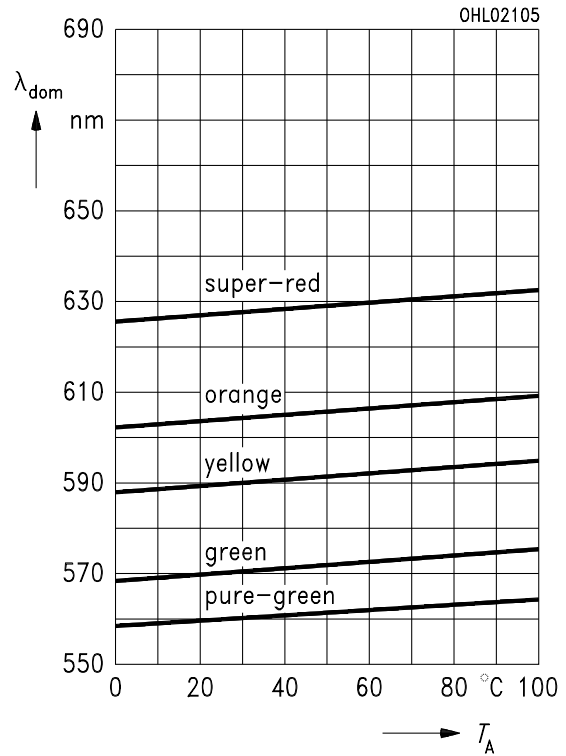

**Durchlaßspannung  $V_F = f(T_A)$**   
**Forward voltage**

$I_F = 10 \text{ mA}$

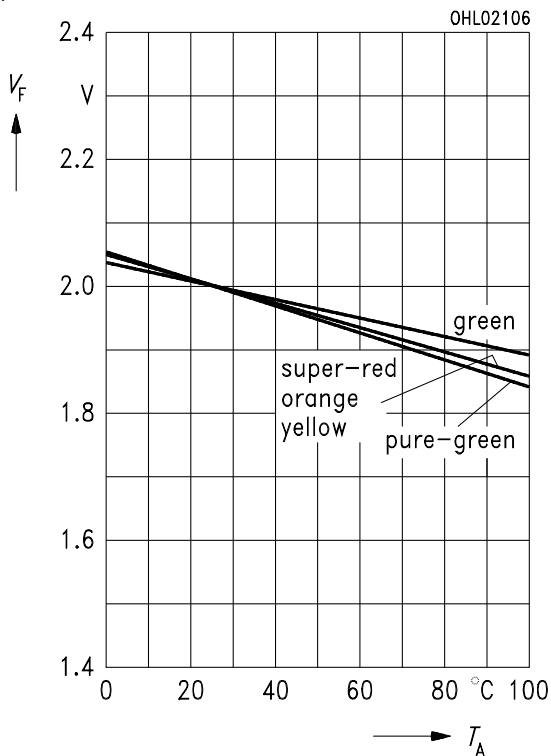

**Relative Lichtstärke  $I_V / I_{V(25^\circ\text{C})} = f(T_A)$**   
**Relative luminous intensity**

$I_F = 10 \text{ mA}$

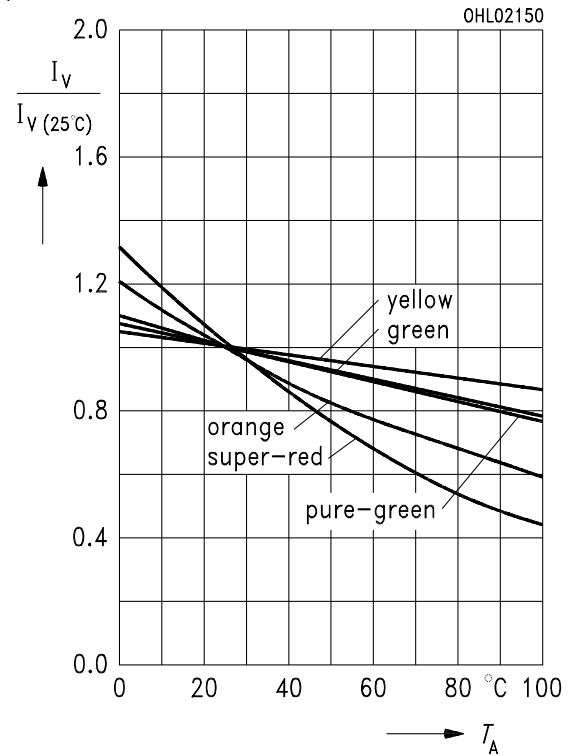

**Maßzeichnung** (Maße in mm, wenn nicht anders angegeben)  
**Package Outlines** (Dimensions in mm, unless otherwise specified)

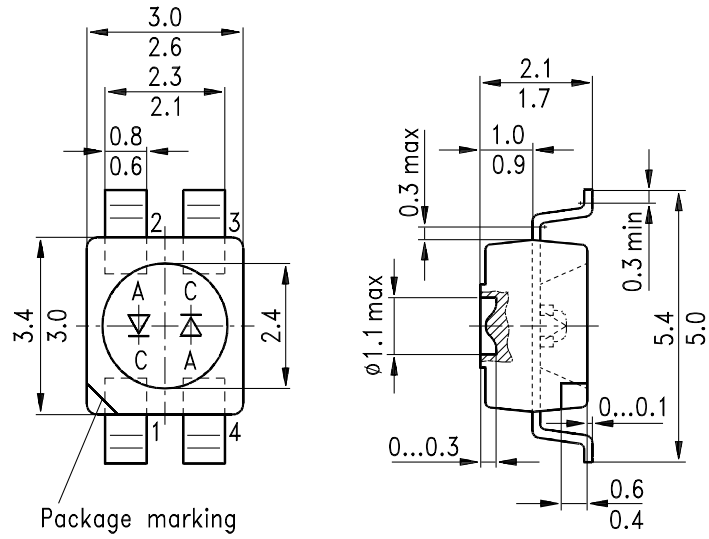

L	S	G	T770
LED	Emission color 1	Emission color 2	Package
	cathode: pin 1	cathode: pin 3	

GPL06908