

Plane MULTILED® 3 mm (T1) LED, Non Diffused

LSP P370, LOP P370

Besondere Merkmale

- farbloses, klares Gehäuse
- zur Einkopplung in Lichtleiter
- als optischer Indikator einsetzbar
- antiparallel geschaltete Leuchtdiodenchips
- hohe Signalwirkung durch Farbwechsel der LED möglich
- bei geeigneter Ansteuerung mit IC (z.B. SDA 2231), Farbwechsel von grün über gelb bis orange (bzw. bis super-rot) möglich
- Lötspieße mit Aufsetzebene
- gegurtet lieferbar
- Störimpulsfest nach DIN 40839

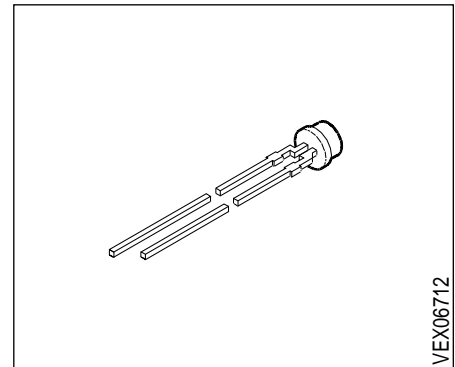

Features

- colorless, clear package
- for optical coupling into light pipes
- for use as optical indicator
- antiparallel chips
- high signal efficiency possible by color change of the LED
- with appropriate controlling by IC (e.g. SDA 2231) it is possible to change color from green to yellow and orange (resp. to super-red)
- solder leads with stand-off
- available taped on reel
- load dump resistant acc. to DIN 40839

Typ Type	Emissionsfarbe Color of Emission	Gehäusefarbe Color of Package	Lichtstrom Luminous Flux $I_F = 15 \text{ mA}$ $\Phi_V \text{ (mlm)}$	Bestellnummer Ordering Code
LSP P370-KN	super-red / pure green	colorless clear	6.3 ... 50	Q62703-Q2439
LSP P370-M			16.0 ... 32	Q62703-Q2671
LSP P370-N			25.0 ... 50	Q62703-Q2672
LSP P370-P			40.0 ... 80	Q62703-Q3232
LSP P370-MQ			16.0 ... 125	Q62703-Q2673
LOP P370-KN	orange / pure green	colorless clear	6.3 ... 50	Q62703-Q2530
LOP P370-M			16.0 ... 32	Q62703-Q2674
LOP P370-N			25.0 ... 50	Q62703-Q2675
LOP P370-MQ			16.0 ... 125	Q62703-Q2676

Streuung des Lichtstromes in einer Verpackungseinheit $\Phi_{V \max} / \Phi_{V \min} \leq 2.0$.¹⁾

Streuung des Lichtstromes in einer LED $\Phi_{V \max} / \Phi_{V \min} \leq 4.0$.

¹⁾ Bei MULTILED® bestimmt die Helligkeit des jeweils dunkleren Chips in einem Gehäuse die Helligkeitsgruppe der LED.

Luminous flux ratio in one packaging unit $\Phi_{V \max} / \Phi_{V \min} \leq 2.0$.¹⁾

Luminous flux ratio in one LED $\Phi_{V \max} / \Phi_{V \min} \leq 4.0$.

¹⁾ In case of MULTILED®, the brightness of the darker chip in one packaging unit determines the brightness group of the LED.

Grenzwerte Maximum Ratings

Bezeichnung Parameter	Symbol Symbol	Werte Values		Einheit Unit
		LS, LO	LP	
Betriebstemperatur Operating temperature range	T_{op}	- 55 ... + 100	- 55 ... + 100	°C
Lagertemperatur Storage temperature range	T_{stg}	- 55 ... + 100	- 55 ... + 100	°C
Sperrschichttemperatur Junction temperature	T_j	+ 100	+ 100	°C
Durchlaßstrom Forward current	I_F	40 ¹⁾	30 ¹⁾	mA
Stoßstrom Surge current $t \leq 10 \mu\text{s}$, $D = 0.005$	I_{FM}	0.5	0.5	A
Verlustleistung Power dissipation $T_A \leq 25 \text{ °C}$	P_{tot}	140	100	mW
Wärmewiderstand Thermal resistance Sperrschicht / Luft Junction / air	$R_{th JA}$	400	400	K/W

1) Die angegebenen Grenzdaten gelten für den Chip, für den sie angegeben sind, unabhängig vom Betriebszustand des anderen.

1) The stated maximum ratings refer to the specified chip, regardless of the other one's operating status.

Kennwerte ($T_A = 25\text{ °C}$)

Characteristics

Bezeichnung Parameter	Symbol Symbol	Werte Values			Einheit Unit
		LS	LO	LP	
Wellenlänge des emittierten Lichtes (typ.) Wavelength at peak emission (typ.) $I_F = 20\text{ mA}$	λ_{peak}	635	610	557	nm
Dominantwellenlänge (typ.) Dominant wavelength (typ.) $I_F = 20\text{ mA}$	λ_{dom}	628	605	560	nm
Spektrale Bandbreite bei 50 % $\Phi_{\text{rel max}}$ (typ.) Spectral bandwidth at 50 % $\Phi_{\text{rel max}}$ (typ.) $I_F = 20\text{ mA}$	$\Delta\lambda$	45	40	22	nm
Durchlaßspannung (typ.) Forward voltage (max.) $I_F = 15\text{ mA}$	V_F	2.1 2.6	2.1 2.6	2.1 2.6	V V
Kapazität ¹⁾ (typ.) Capacitance ¹⁾ $V_R = 0\text{ V}, f = 1\text{ MHz}$	C_0	12	8	15	pF
Schaltzeiten: Switching times: I_V from 10 % to 90 % (typ.) I_V from 90 % to 10 % (typ.) $I_F = 100\text{ mA}, t_p = 10\text{ }\mu\text{s}, R_L = 50\text{ }\Omega$	t_r t_f	300 150	300 150	450 200	ns ns

¹⁾ Die Gesamtkapazität ergibt sich aus der Summe der Einzelkapazitäten.

¹⁾ The total capacitance results from the sum of the single capacitances.

Relative spektrale Emission $\Phi_{rel} = f(\lambda)$, $T_A = 25^\circ\text{C}$, $I_F = 20\text{ mA}$

Relative spectral emission

$V(\lambda)$ = spektrale Augenempfindlichkeit

Standard eye response curve

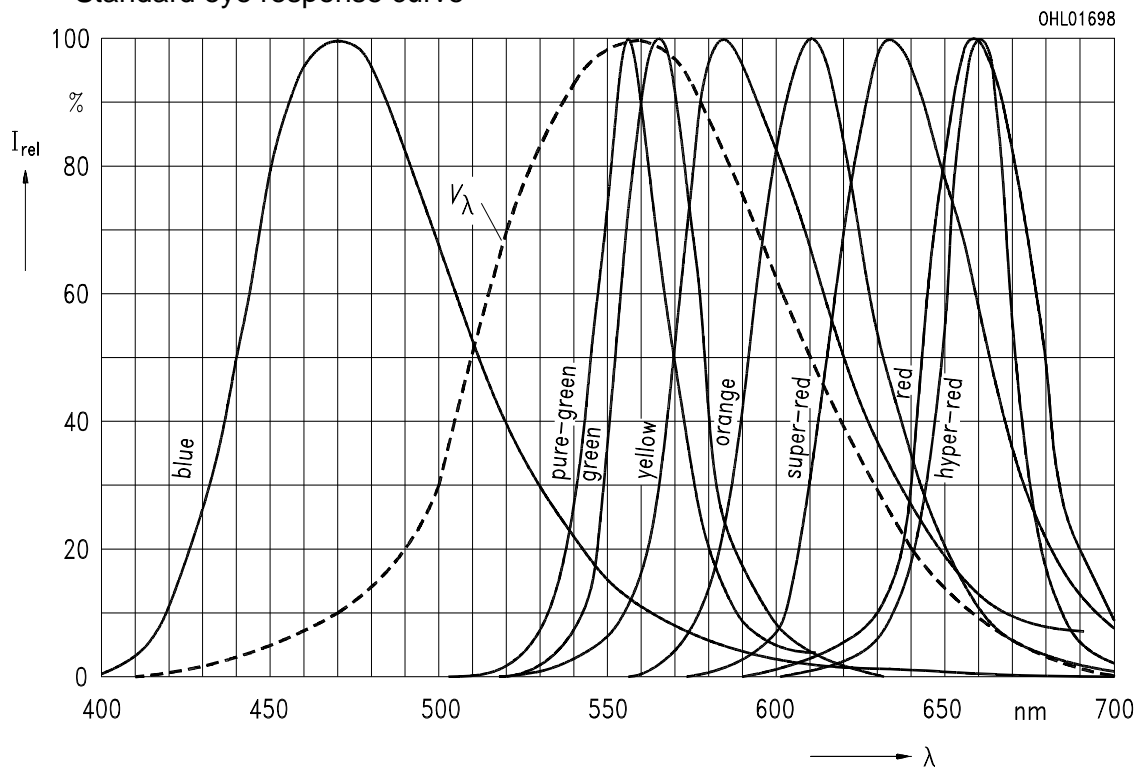

Abstrahlcharakteristik $\Phi_{rel} = f(\varphi)$

Radiation characteristic

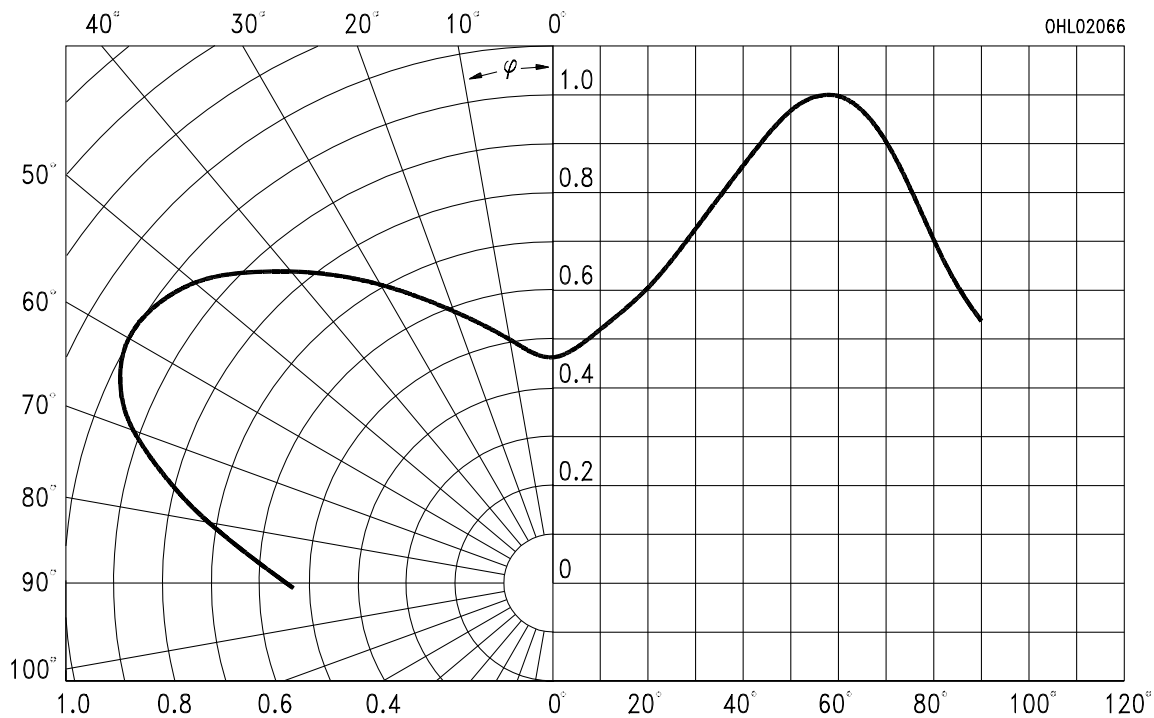

Durchlaßstrom $I_F = f(V_F)$

Forward current

$T_A = 25^\circ\text{C}$

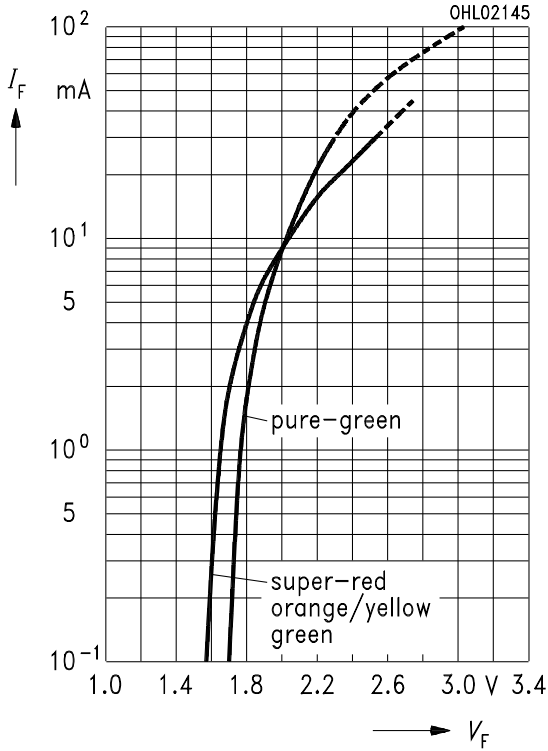

Relativer Lichtstrom $\Phi_V / \Phi_{V(15\text{mA})} = f(I_F)$

Relative luminous flux

$T_A = 25^\circ\text{C}$

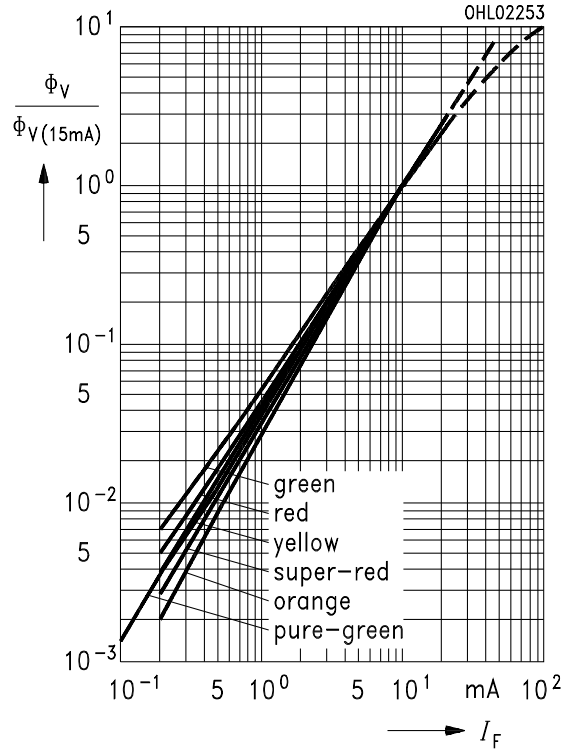

Zulässige Impulsbelastbarkeit $I_F = f(t_p)$

Permissible pulse handling capability

Duty cycle $D =$ parameter, $T_A = 25^\circ\text{C}$

LS, LO

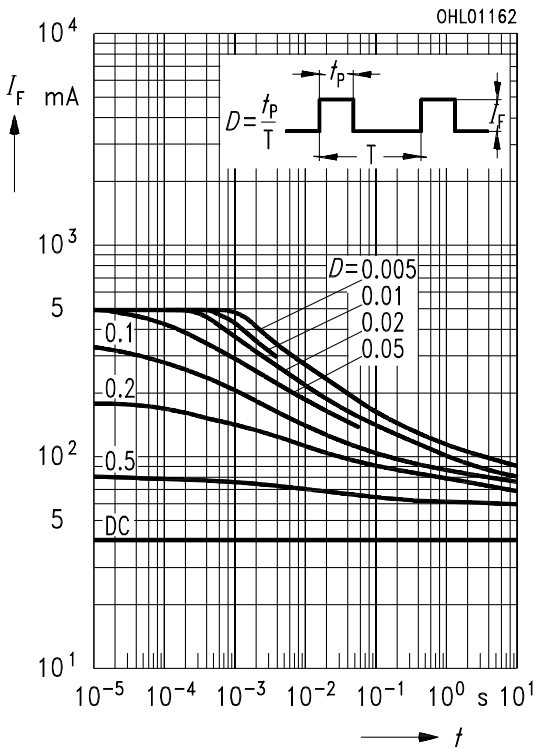

Zulässige Impulsbelastbarkeit $I_F = f(t_p)$

Permissible pulse handling capability

Duty cycle $D =$ parameter, $T_A = 25^\circ\text{C}$

LP

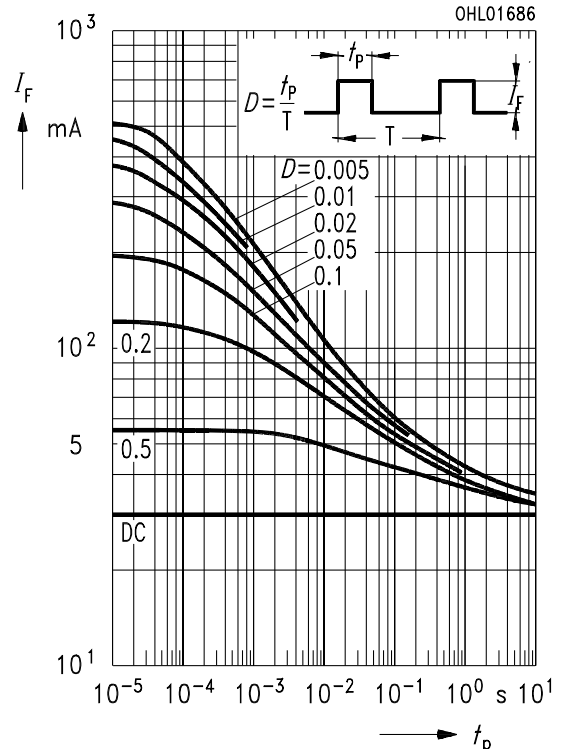

Maximal zulässiger Durchlaßstrom
Max. permissible forward current

$I_F = f(T_A)$, LS, LO

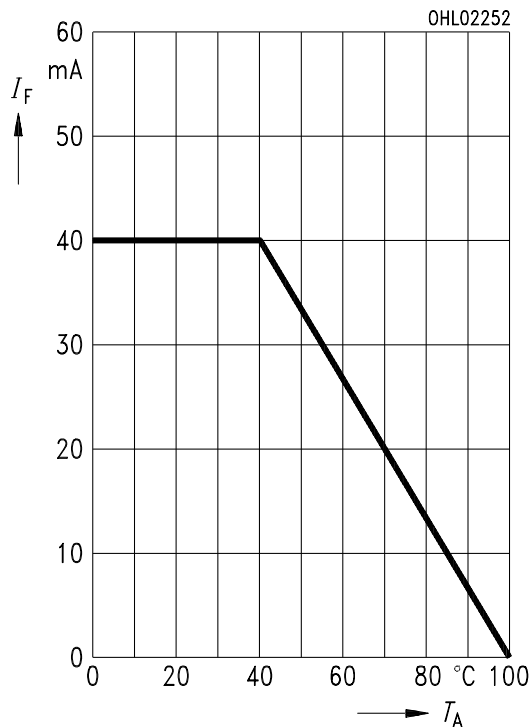

Maximal zulässiger Durchlaßstrom
Max. permissible forward current

$I_F = f(T_A)$, LP

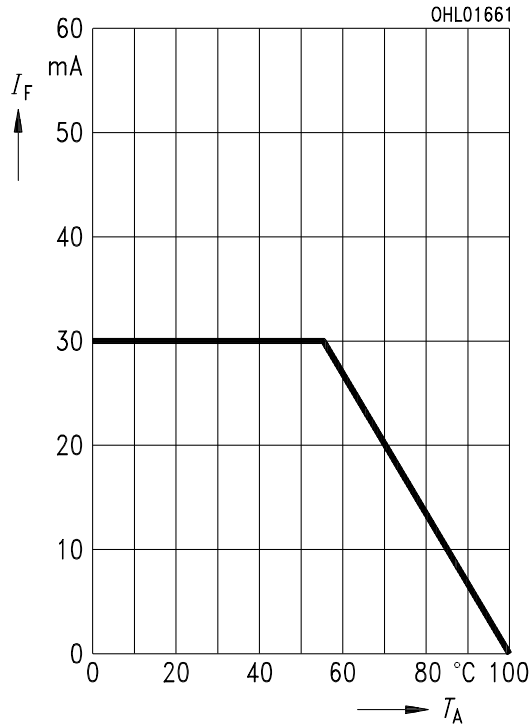

Wellenlänge der Stahlung $\lambda_{peak} = f(T_A)$
Wavelength at peak emission

$I_F = 20$ mA

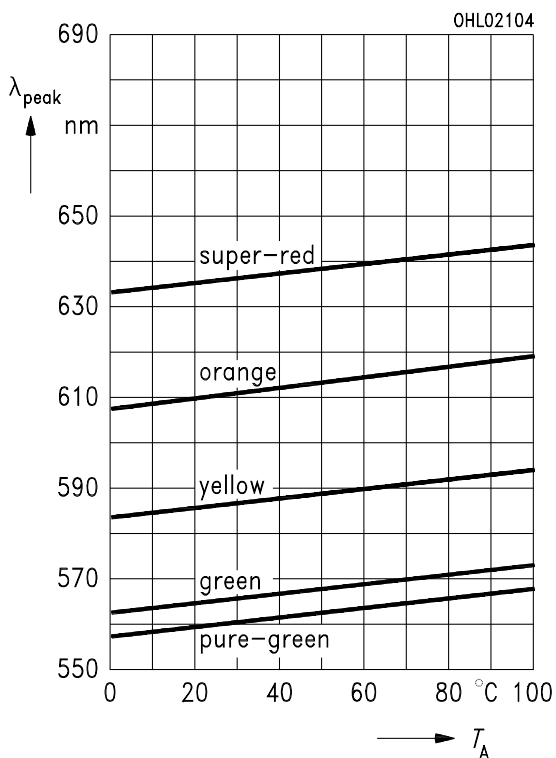

Dominantwellenlänge $\lambda_{dom} = f(T_A)$
Dominant wavelength

$I_F = 20$ mA

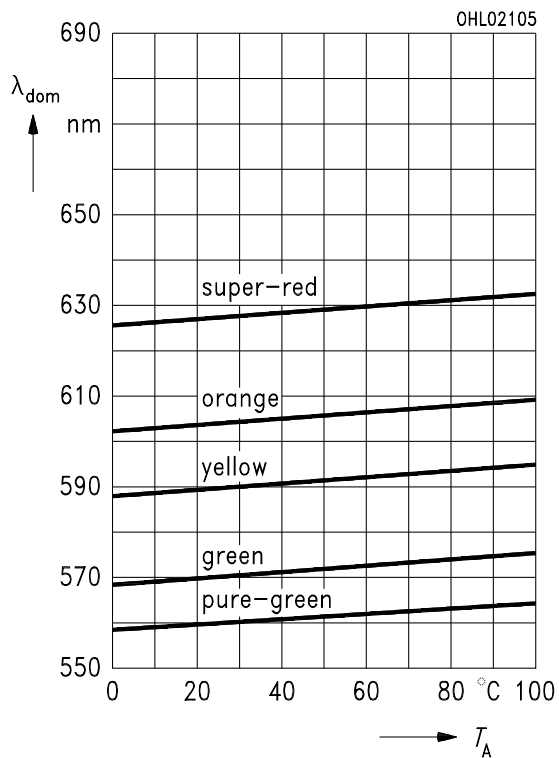

Durchlaßspannung $V_F = f(T_A)$

Forward voltage

$I_F = 15 \text{ mA}$

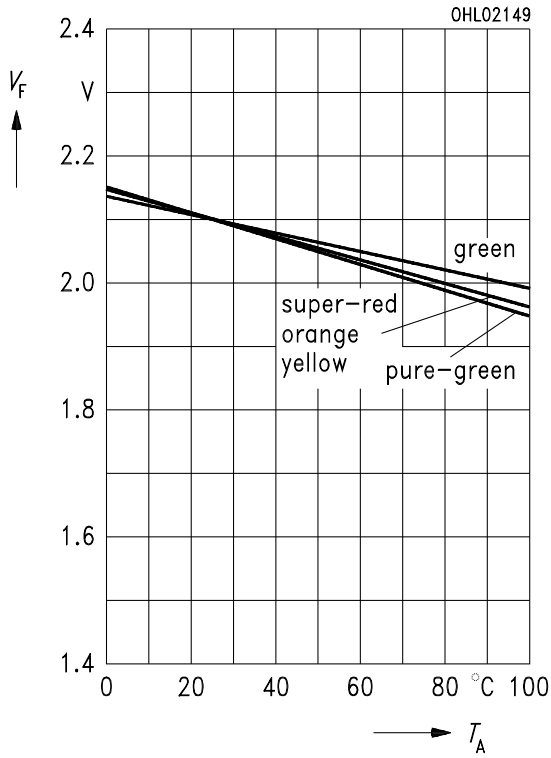

Relativer Lichtstrom $\Phi_V / \Phi_{V(25^\circ\text{C})} = f(T_A)$

Relative luminous flux

$I_F = 15 \text{ mA}$

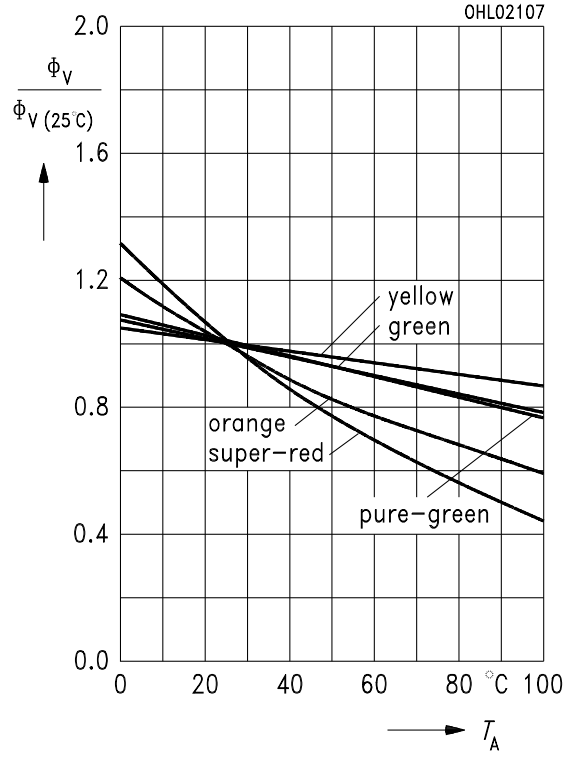

Maßzeichnung (Maße in mm, wenn nicht anders angegeben)
Package Outlines (Dimensions in mm, unless otherwise specified)

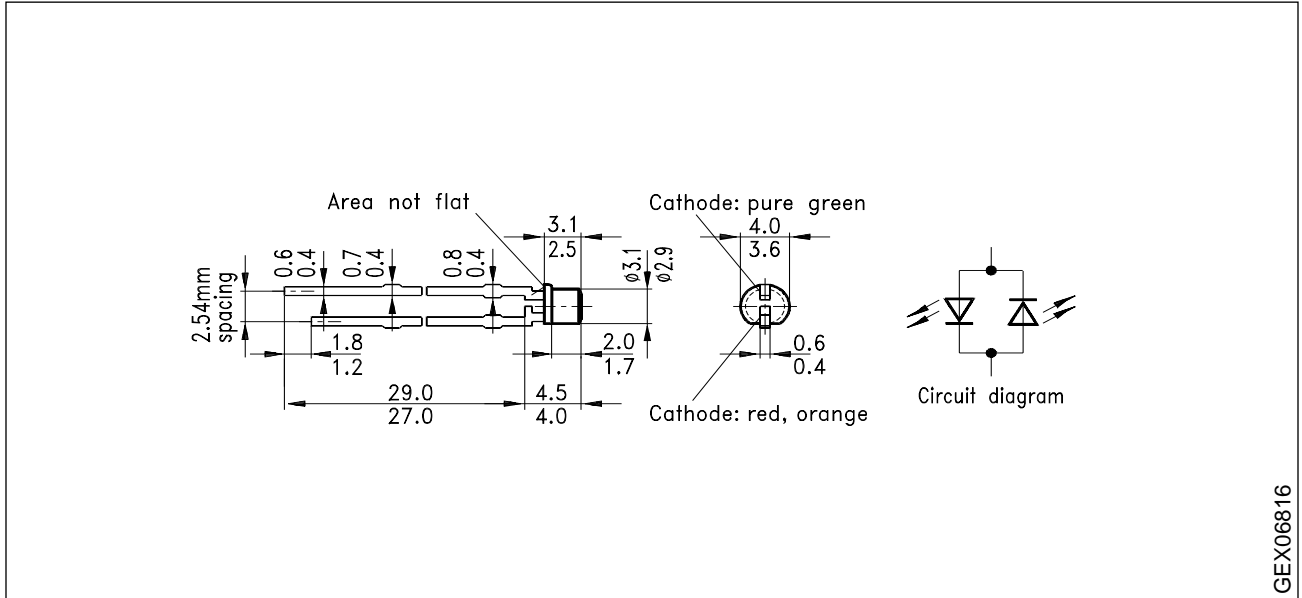

Cathode mark, pure green: Long solder lead
Cathode mark, red, orange: Short solder lead

GEX06816