

## Video Modulator for FM/AM-Audio

**MGM 3000X**

**Bipolar IC**

### Features

- FM- and AM-audio modulator
- Audio carrier output for suppression of harmonics
- Sync level clamping of video input signal
- Controlling of peak white value
- Continuous adjustment of modulation depth for positive or negative values
- Symmetrical mixer output with separate ground area
- Symmetrical oscillator with separate RF-ground
- Low spurious radiation
- High stability of the RF-oscillator frequency
- High stability of the audio oscillator
- Internal reference voltage
- 12 V supply voltage

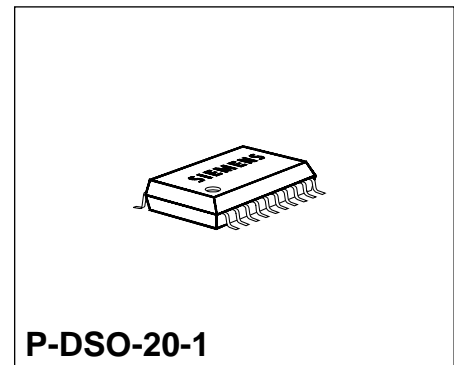

Type	Ordering Code	Package
MGM 3000X	Q67000-A5179	P-DSO-20-1 (SMD)
MGM 3000X	Q67006-A5179	P-DSO-20-1 Tape & Reel (SMD)

### Functional Description and Application

The monolithic integrated circuit MGM 3000X is especially suitable as a modulator for the 48 to 860 MHz frequency range.

Video recorders, cable converters, TV-converter networks, demodulators, video generators, video security systems, amateur TV-applications and personal computers.

### Circuit Description

#### Oscillator

The RF-oscillator is available at pins 3 - 7. The oscillator operates as a symmetrical Colpitts circuit. The oscillator chip ground, pin 5, should be connected to ground at the resonance circuit shielding point. An external oscillator can be injected inductively or capacitively via pins 3 and 7. The layout of the PCB should be such as to provide a minimum shielding attenuation between the oscillator pins 3 - 7 and modulator output pins 15 - 17 of approximately 80 dB.

For optimal residual carrier suppression, the symmetrical mixer outputs at pins 15, 17 should be connected to a matched balanced-to-unbalanced broadband transformer, e.g. a Guanella transformer with good phase precision at  $0^\circ$  and  $180^\circ$ . The transmission loss should be less than 3 dB. In addition, an LC-low pass filter combination is required at the output. The cut-off frequency of the low pass filter combination must exceed the maximum operating frequency.

### Video

The video signal with the negative synchronous level is capacitively connected to pin 12. The internal clamping circuit is referenced to the synchronizing level. Should the video signal change by 6 dB, this change will be compensated by the resonance circuit which is set by the peak white value. At pin 13, the current pulses of the peak white detector are filtered through the capacitor which also determines the control time constant. The RF-carrier switches from negative to positive video modulation, when pin 14 is connected to ground. By varying the value of resistance  $R$  at pin 14 between  $\infty \dots 0 \Omega$  the modulation depth can be increased from 70 % to 100 % when the modulation is negative and decreased from 100 % to 70 % when the modulation is positive.

### Audio

Via pin 1, the audio signal is capacitively coupled to the AF-input for the FM-modulation of the oscillator. A parallel resonance circuit is connected to the audio carrier oscillator at pins 19, 20. The unloaded  $Q$  of the resonant circuit must be  $Q = 25$  and the parallel resistor  $R_T = 6.8 \text{ k}\Omega$  to ensure a video to audio carrier ratio of 12.5 dB. At the same time, capacitive and/or inductive reactance for the resonance frequency should have a value of  $X_C \approx X_L \approx 800 \Omega$ .

Via pin 18, the audio signal is capacitively coupled to the AF-input for the AM-modulation of the oscillator. This signal is forwarded to a mixer which is influenced by the AM-modulation input of pin 18. The video to audio carrier ratio can be changed by connecting an external voltage to pin 18, which deviates from the internal reference voltage. Through an additional external dc voltage at pin 18, the set AM-modulation index can be changed by overriding the internally adjusted control voltage for a fixed AM-modulation index.

At the output of the above described mixer the FM and/or AM modulated audio signal is added to the video signal and mixed with the oscillator signal in the RF-mixer.

For optimal suppression of harmonics of the audio carrier an audio filter should be connected between pin 10 and 11.

### Source

The internal reference voltage is available at pin 2 and has to be capacitively blocked there.

Pin Configuration  
(top view)

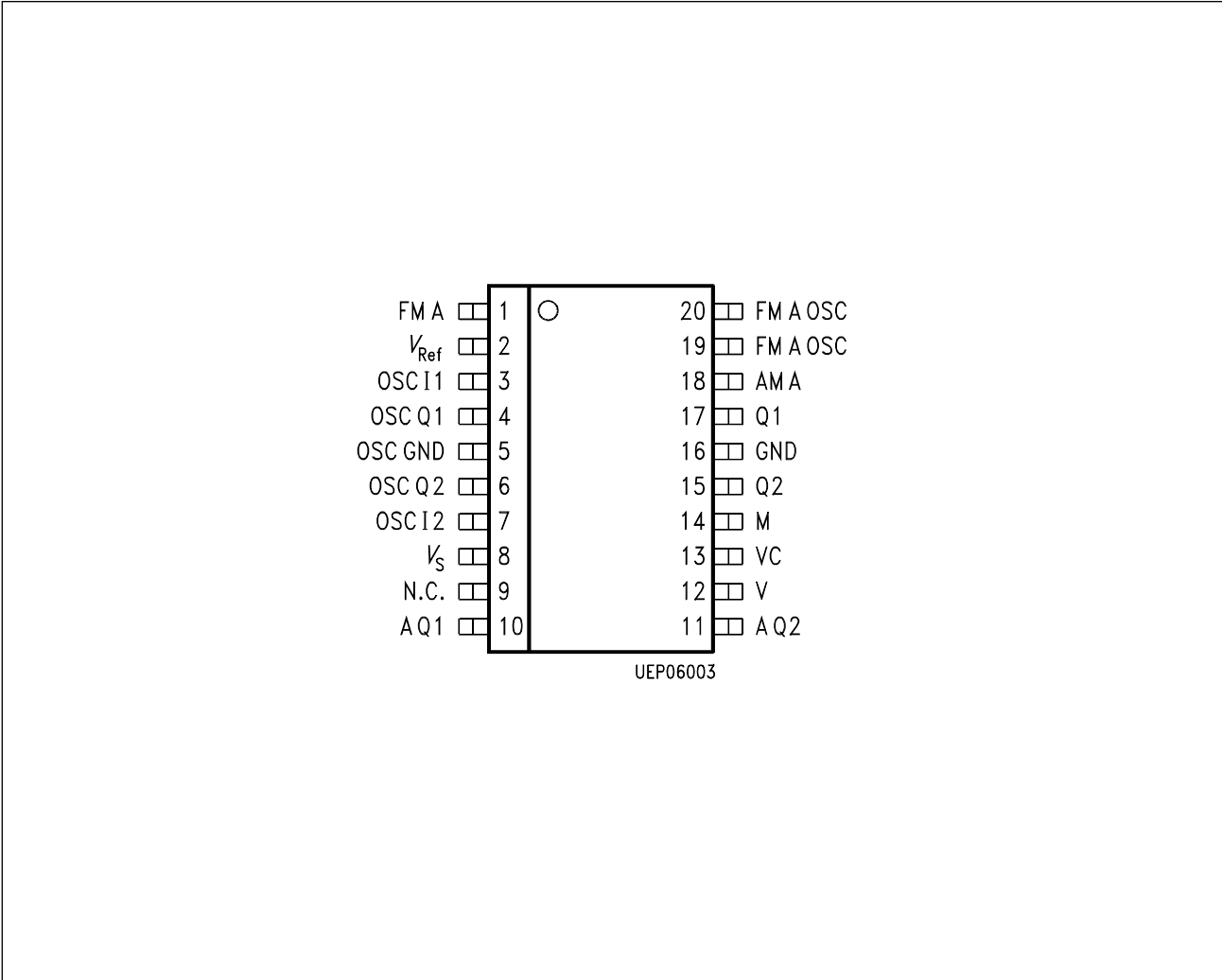

## Pin Definitions and Functions

Pin No.	Symbol	Function
1	FM-Audio	AF-input for FM-modulation
2	$V_{REF}$	Internal reference voltage (7.5 V)
3	OSC-Input 1	Symmetrical oscillator input
4	OSC-Out 1	Symmetrical oscillator output
5	OSC-Ground	Oscillator ground
6	OSC-Out 2	Symmetrical oscillator output
7	OSC-Input 2	Symmetrical oscillator input
8	$V_S$	Supply voltage (12 V)
9	N.C.	Not connected
10	Audio Out 1	Audio output; symmetrical inputs for audio filter
11	Audio Out 2	Audio output; symmetrical inputs for audio filter
12	Video	Video input with clamping
13	Video-Cap.	Connection for smoothing capacitor for video control loop
14	Modulation	Switch-over for positive and negative modulation
15	Output 2	Symmetrical RF-output
16	Ground	Ground
17	Output 1	Symmetrical RF-output
18	AM-Audio	Video to audio carrier ratio adjustment and AF-input for AM-modulation
19	FM-Audio OSC	FM-audio oscillator, symmetrical inputs for tank circuit
20	FM-Audio OSC	FM-audio oscillator, symmetrical inputs for tank circuit

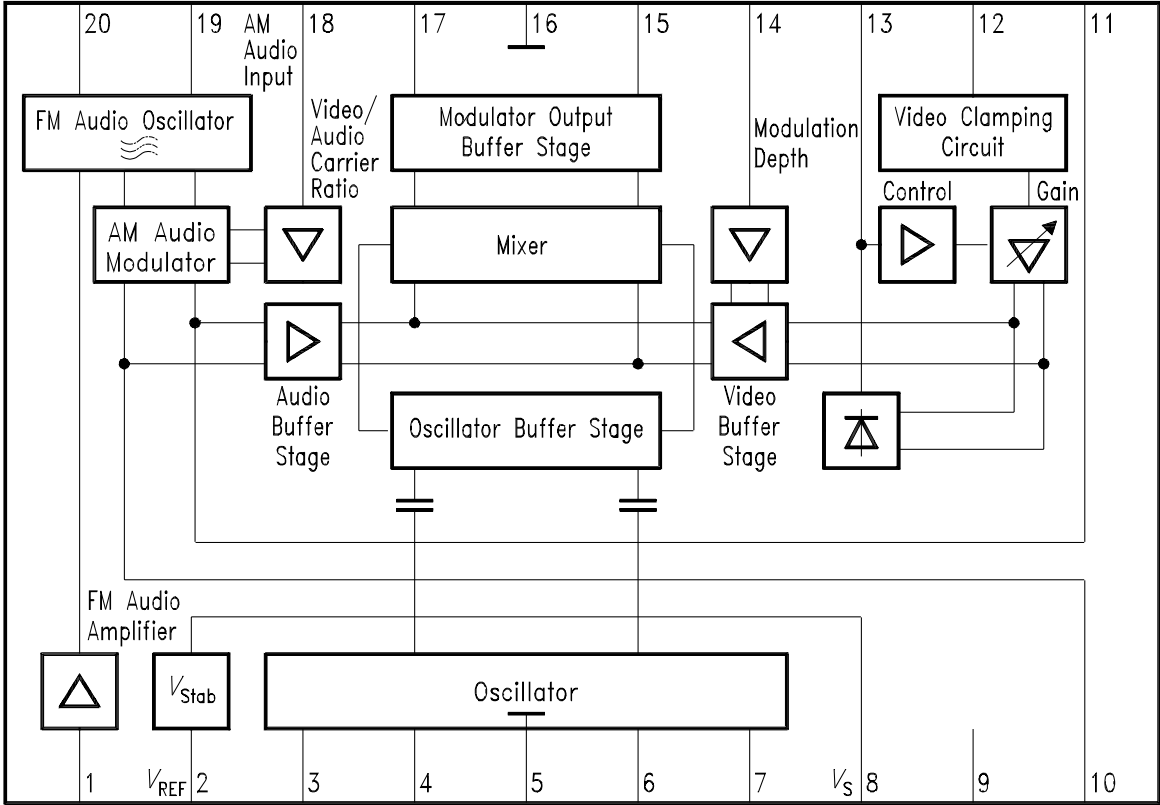

UEB05984

Block Diagram

## Absolute Maximum Ratings

$T_A = 0$  to  $70\text{ °C}$

Parameter	Symbol	Limit Values			Unit	Remarks
		min.	typ.	max.		
Supply voltage pin 8	$V_S$	- 0.3		14.5	V	
Current from pin 2	$- I_2$	0		2	mA	$V_2 = 7-8\text{ V}$ , $V_S = 10-13.5\text{ V}$
Voltage at pin 1	$V_1$	0		2	V	only via $C$ (max.1 $\mu\text{F}$ )
Voltage at pin 2	$V_2$	6		8.5	V	
Voltage at pin 12	$V_{10}$	0		1.5	V <sub>pp</sub>	
Capacitance at pin 2	$C_2$	0		100	nF	
Capacitance at pin 13	$C_{13}$	0		15	$\mu\text{F}$	
Voltage at pin 14	$V_{14}$	- 0.3		1.4	V	$V_S = 10-13.5\text{ V}$
Voltage at pin 15	$V_{15}$	$V_2$		13.5	V	
Voltage at pin 17	$V_{17}$	$V_2$		13.5	V	
Voltage at pin 18	$V_{18}$	$V_2 - 1.5$		$V_2 + 1.5$	V	

According to the application circuit, only the provided circuitry can be connected to pins 3, 4, 6, 7, 10, 11, 18 and 20.

Junction temperature	$T_j$			150	°C	
Storage temperature	$T_{stg}$	- 40		125	°C	
Thermal resistance	$R_{th}$			80	K/W	

## Operating Range

Supply voltage	$V_S$	10		13.5	V	
Video input frequency	$f_{\text{Video}}$	0		6	MHz	
Audio input frequency	$f_{\text{AF}}$	0		20	kHz	
Output frequency	$f_Q$	30		860	MHz	depending on the oscillator circuitry at pins 3-7
Ambient temperature	$T_A$	0		80	°C	

**Absolute Maximum Ratings (cont'd)**

$T_A = 0$  to  $70$  °C

Parameter	Symbol	Limit Values			Unit	Remarks
		min.	typ.	max.		
Audio oscillator	$f_{OSC}$	4		7	MHz	
Voltage at pin 2	$V_2$	7		7.50	V	
Voltage at pin 15, 17	$V_{15,17}$	$V_2$		$V_S$	V	

**AC/DC Characteristics**

$T_A = 25$  °C;  $V_S = 12$  V

Parameter	Symbol	Limit Values			Unit	Test Condition	Test Circuit
		min.	typ.	max.			

**Source**

Current consumption	$I_8$	15	20	26	mA	$I_2 = 0$ mA	1
Current consumption	$I_{15} + I_{17}$	2.0	2.6	3.4	mA		
Reference voltage	$V_2$	7.00	7.25	7.50	V	$0 \leq I_2 \leq 1$ mA	1

**Oscillator**

Oscillator frequency range	$f_{OSC}$	30		860	MHz	external circuitry adjusted to frequency	
Switch-on, warm up drift TC-value of capacitor in osc. circuit is 0; drift is referenced only to selfheating of the component.	$\Delta f_{OSC}$	0	- 50	- 500	kHz	$t = 0.5-10$ s; $T_A = \text{const.}$ Ch 30 Ch 40	1
		0	- 200	- 500	kHz		1
Frequency drift as function of $V_S$	$\Delta f_{OSC}$	- 150		150	kHz	$V_S = 10-13.5$ V $T_A = \text{const.};$ Ch 40	1
RF-output impedance	$R_{15}; R_{17}$	10			k $\Omega$	parallel equivalent circuit	1
	$C_{15}; C_{17}$	0.5	1	2.0	pF	parallel equivalent circuit	1

**AC/DC Characteristics (cont'd)**

$T_A = 25\text{ °C}; V_S = 12\text{ V}$

Parameter	Symbol	Limit Values			Unit	Test Condition	Test Circuit
		min.	typ.	max.			
RF-output voltage	$V_Q$	2.5	4.5	5.5	mVrms	Ch 60; video 100 % white; without audio- signal	1
RF-output phase	$a_{15, 17}$	140	180	220	deg		
RF-output voltage changes	$\Delta V_Q$	0		1.5	dB	$f = 743.25\text{-}823.25\text{ MHz}$ $\Delta f = 80\text{ MHz};$ Ch 55-65	1
	$\Delta V_Q$	0		1.5	dB	$f = 100\text{-}300\text{ MHz}$	1
	$\Delta V_Q$	0		1.5	dB	$f = 48\text{-}100\text{ MHz}$	1
Intermodulation ratio	$a_{IMR}$	60	75		dB	$f_{VC} + 1.07\text{ MHz}$ $f_{VC} + 1.57\text{ MHz}$ $f_{VC} + 2.07\text{ MHz}$	2
Harmonic wave ratio	$a_O$	60			dB	$f_{VC} + 8.8\text{ MHz}$ $f_{VC} + 13.29\text{ MHz}$ $f_{VC} + 17.72\text{ MHz},$ without video	2

13, 14, 15 unmodulated video and audio carrier, measured with the spectrum analyzer as difference between video carrier signal level and sideband signal level; loaded  $Q$  factor  $Q_L$  of the audio oscillator resonance circuit adjusted by  $R_P$  to provide the required video to audio carrier ratio of 12.5 dB;  $Q_U = 25$ .

Video to audio carrier ratio	$a_{V/A}$	10	12.5	15	dB	$f_{VC} + f_{AC} (5.5\text{ MHz})$	1
Harmonic wave ratio	$a_O$	60			dB	$f_{VC} + 2f_{AC} (11\text{ MHz})$	1
	$a_O$	80			dB	$f_{VC} + 3f_{AC} (16.5\text{ MHz})$	1



## AC/DC Characteristics (cont'd)

$T_A = 25\text{ °C}$ ;  $V_S = 12\text{ V}$

Parameter	Symbol	Limit Values			Unit	Test Condition	Test Circuit
		min.	typ.	max.			
All remaining harmonic waves; multiple of fundamental wave of video carrier, without video signal, measured with spectrum analyzer; $f_{VC} = 523.25\text{--}623.25\text{ MHz}$ ; pin 14 open.	$a$	15			dB		1
Residual carrier suppression	$a_R$	32			dB	Ch 30 ... 40	3
Signal-to-noise in video; unmodulated audio carrier	$a_{NV}$	48	74		dB	Ch 60	4
Interference product ratio audio in video AM-modulation FM-modulation of audio carrier	$a_{AV}$	49	62		dB	Ch 60; $m_A = 90\%$	4
	$a_{AV}$	48	60		dB	Ch 60; $\pm 35\text{ kHz}$	4
Unweighted AM	$a_{V/A}$	48	54		dB	Ch 39; test picture FuBK	5
Unweighted FM	$a_{V/A}$	48	54		dB	Ch 39; test picture FuBK	5
Interference level ratio video in audio							
Signal-to-noise ratio of audio oscillator	$a_{N/A}$	48	54		dB	AM unmodulated	5
	$a_{N/A}$	48	54		dB	FM video carrier	5

## Video

Video input current at pin 12	$-I_{12}$	0		1	$\mu\text{A}$	$C_{12} \leq 100\text{ nF}$	1
Video input voltage at pin 12	$V_{12}$	0.7		1.4	Vpp	$C_{12} \leq 100\text{ nF}$	1

**AC/DC Characteristics (cont'd)**

$T_A = 25\text{ °C}$ ;  $V_S = 12\text{ V}$

Parameter	Symbol	Limit Values			Unit	Test Condition	Test Circuit
		min.	typ.	max.			
Modulation depth	$m_{D/N}$	70		90	%	staircase signal at video input; $V_{\text{Video}} = 1\text{ Vpp}$	6
	$m_{D/P}$	80		98	%		
Stability of mod. depth	$\Delta m_D$		1	$\pm 2.5$	%	$\Delta V_{\text{Video}} = 1\text{ Vpp} \pm 3\text{ dB}$ ; $T_A = 0\text{-}60\text{ °C}$ $V_S = 10\text{-}13.5\text{ V}$	6
Stability of mod. depth	$\Delta m_D$		1	$\pm 2.0$	%		6
Stability of mod. depth	$\Delta m_D$		1	$\pm 2.0$	%		6
Differential gain	$a_{\text{dif}}$			10	%		7
Differential phase	$\Phi_{\text{dif}}$			15	deg	measured with measurement demodulator, video test signals and vector scope	7
Amplitude response of video signal; $V_{\text{Video}} = 1\text{ Vpp}$ with additional modulation $f = 15\text{ kHz-}5\text{ MHz}$ sine signal between black and white.	$a_V$	0		1.5	dB		8
Period of time required for peak white detector to reach steady state for full modulation depth with 1-white pulse per half frame when control is already in the steady state.	$t$		6	50	$\mu\text{s}$	$C$ at pin 13 = $10\text{ }\mu\text{F}$ $I_{\text{leakage}} \leq 2\text{ }\mu\text{A}$	1
Setting time for video signal change from 0 Vpp to 1.4 Vpp, video blanking signal content is uniform white level.	$t$		120	500	$\mu\text{s}$		1

**AC/DC Characteristics (cont'd)** $T_A = 25\text{ °C}; V_S = 12\text{ V}$ 

Parameter	Symbol	Limit Values			Unit	Test Condition	Test Circuit
		min.	typ.	max.			
Setting time for video blanking signal from 100 % white level to 42 % grey level with subsequent rise in grey level to 71 % of video blanking signal (due to decontrol process).	$t$	0.4	2	10	min		1

**Audio**

Audio oscillator frequency range; unloaded $Q$ factor of resonance circuit $Q_U = 25$ ; $f_{\text{resonance}} = 5.5\text{ MHz}$ .	$f_{A/OSC}$	4		7	MHz		1
Switch-on, warm-up drift of oscillator frequency; TC-value of capacitor in audio oscillator circuit is 0, the drift is only based on self-heating of component.	$\Delta f_{A/OSC}$			5	kHz	$T_A = \text{const.};$ > 5 s after switching on	1
Audio signal frequency deviation	$\Delta f_{A/OSC}$			5	kHz	$V_S = 12\text{ V} \pm 10\%$ $Q_U = 25$	1

**AM-Audio**

AM-mod. factor	$m$	50		70	%	$V_{AF} = 90\text{ mVrms}$	9
AM-mod.; total harmonic distortion	$THD_{AM}$		0.5	3	%	$m = 80\%$ ; $V_{AF} = 117\text{ mVrms}$ ; $f_{AF} = 1\text{ kHz}$	9
Audio preamplifier input impedance	$Z_{18}$	25	50	75	k $\Omega$		1

**AC/DC Characteristics (cont'd)** $T_A = 25\text{ °C}; V_S = 12\text{ V}$ 

Parameter	Symbol	Limit Values			Unit	Test Condition	Test Circuit
		min.	typ.	max.			
AM-audio modulator input voltage	$V_{AF}$		132		mVrms	$m = 90\%$ ; $f_{AF} = 1\text{ kHz}$	9
Residual carrier FM; AM-operation	$\Delta f$		20		Hz	without AM-audio signal $Q_U = 25$	1

**FM-Audio**

FM-mod.; total harmonic distortion	$THD_{FM}$		0.6	1.5	%	$V_1 = 150\text{ mVrms}$	9
FM-mod.; static mod. characteristic	$\Delta f_{AOSC}$	$\pm 150$	$\pm 210$	$\pm 270$	kHz	$\Delta V_{AF} = V_1 - V_2 = \pm 1\text{ V}$	1
FM-mod.; dynamic mod. characteristic	$\frac{\Delta f_{AOSC}}{\Delta V_{AF}}$	0.30	0.33	0.36	kHz/mV	BIN 1	1
		0.25		0.30	kHz/mV	BIN 2	
		0.36		0.44	kHz/mV	BIN 3	
Audio preamplifier input impedance (dynamic); FM-operation	$Z_1$	200			k $\Omega$		1

**Overshoot**

Overshoot				1	%	15-kHz video signal	
-----------	--	--	--	---	---	---------------------	--

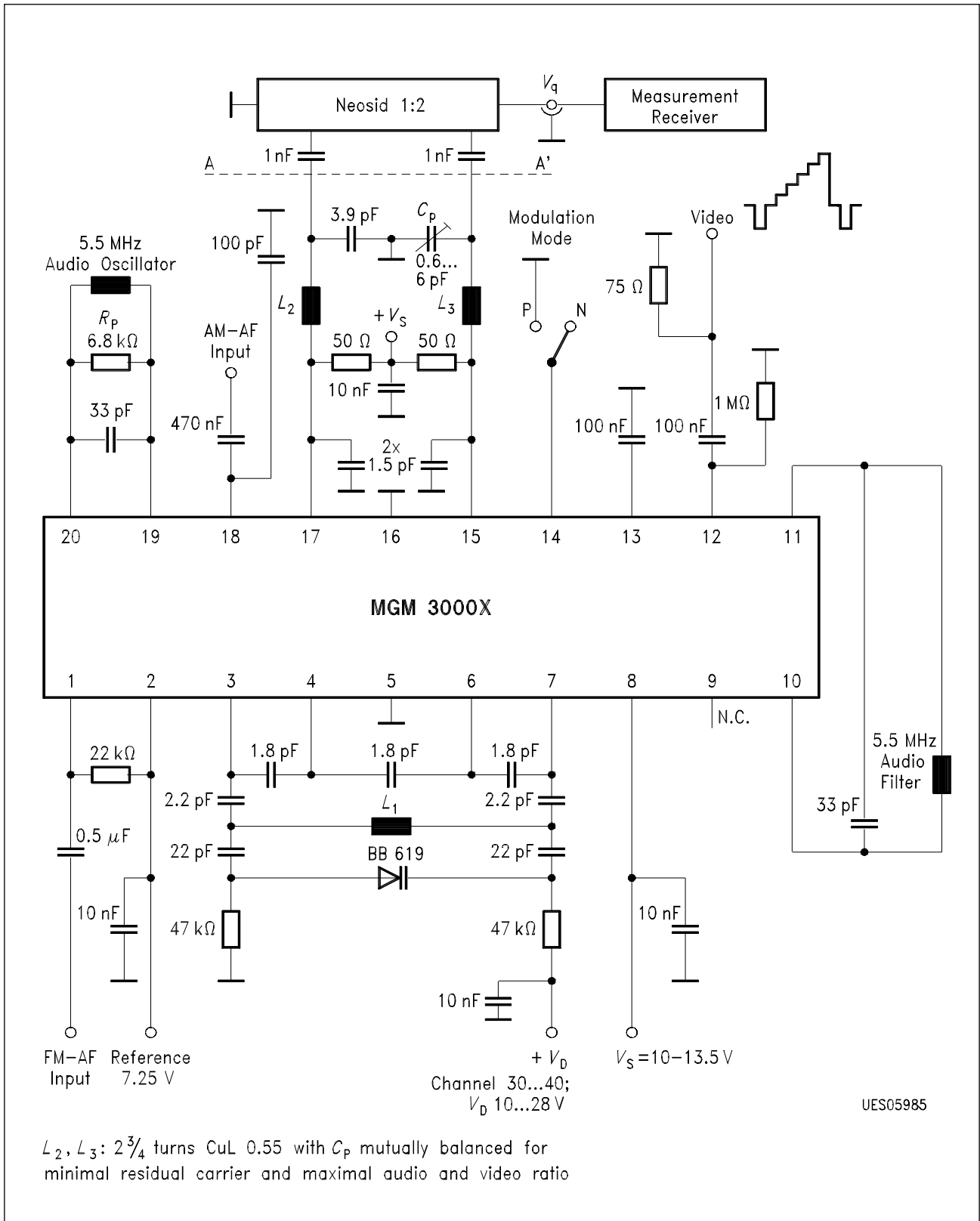

**Test Circuit 1**  
**Test and Measurement Circuit for AM- and FM-Audio Carrier and Negative Video Modulation**

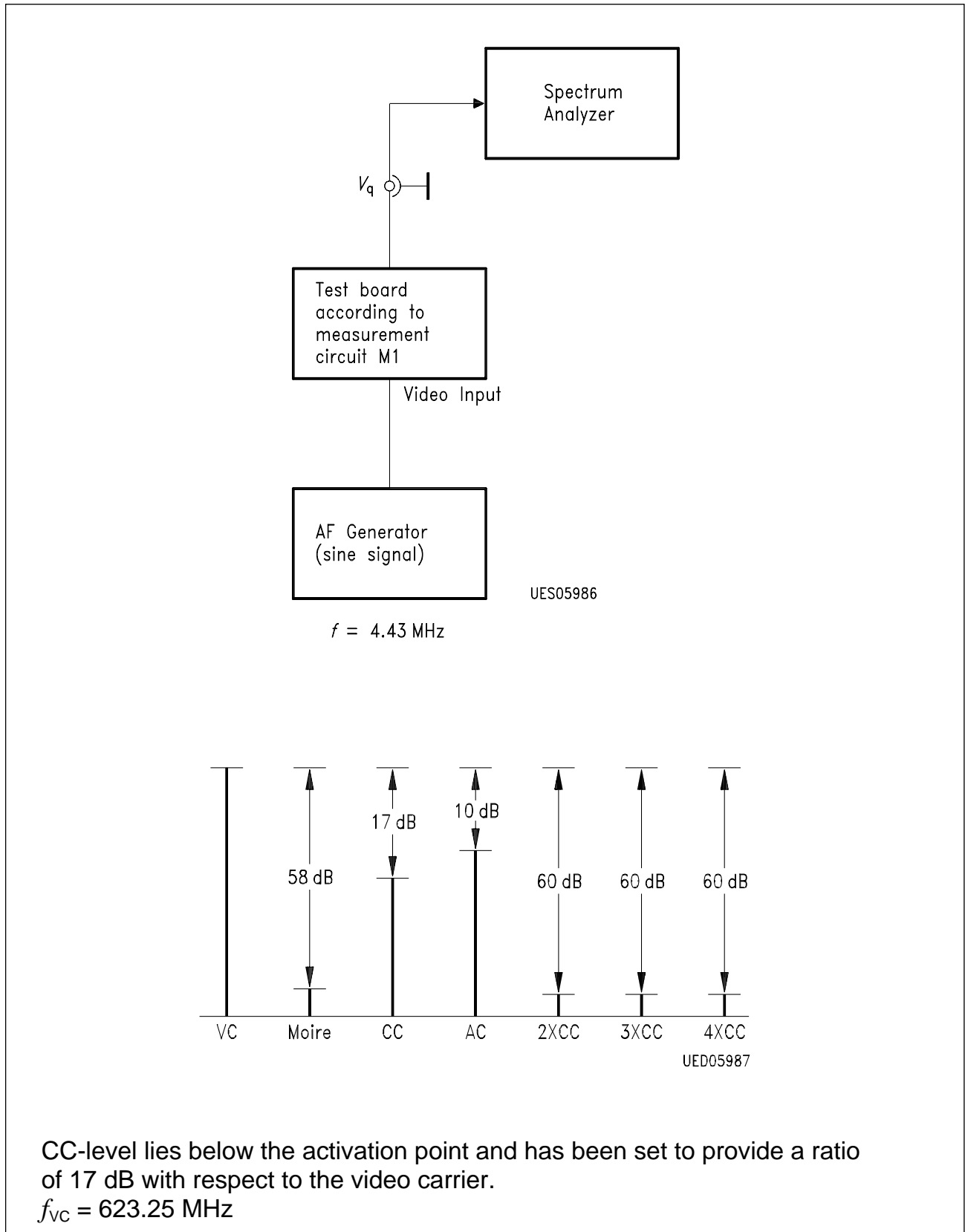

**Test Circuit 2**  
**Description of the Measurement Configuration to Measure the Moire**

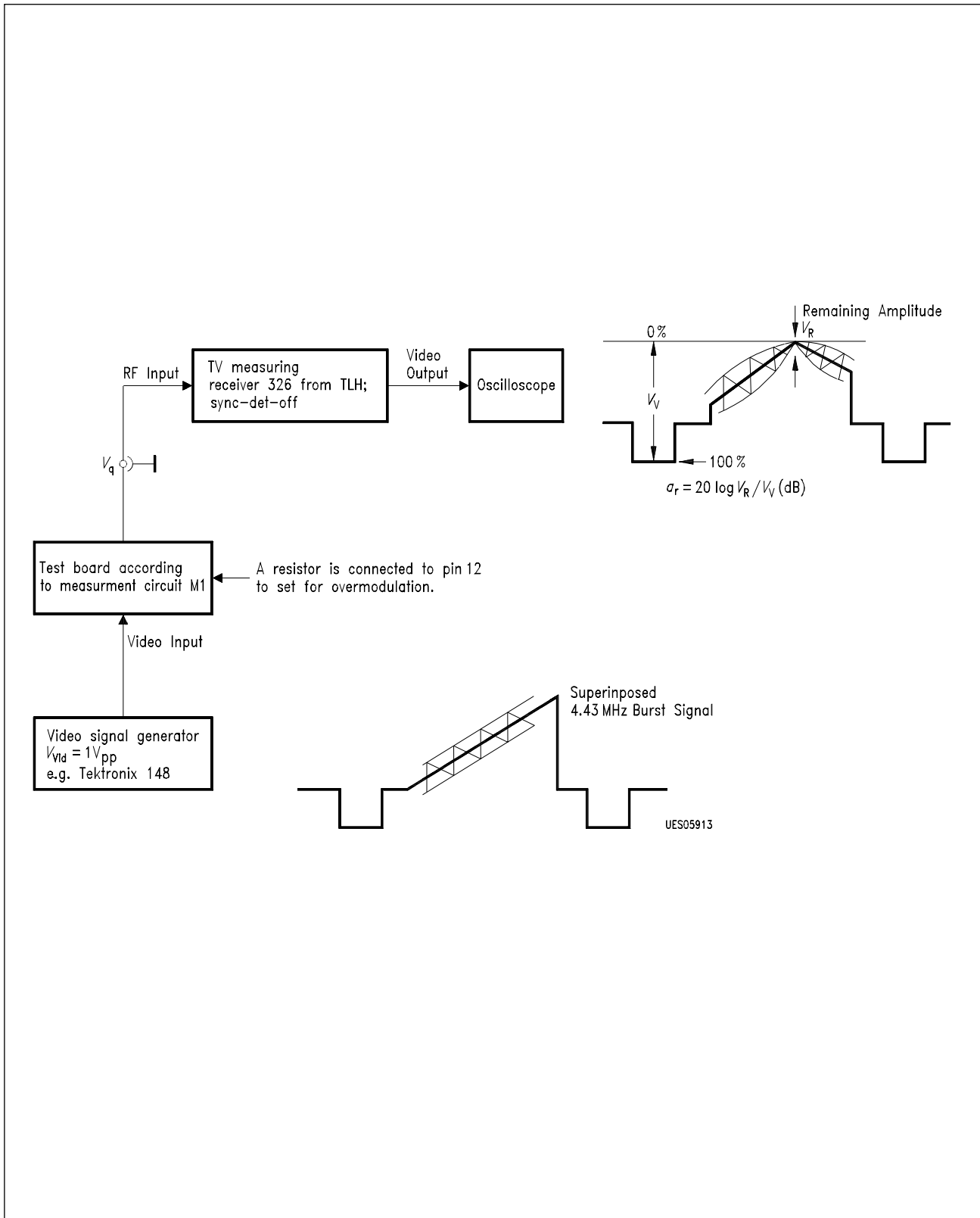

**Test Circuit 3**  
**Description of the Measurement Configuration to Measure the Residual Carrier Suppression**

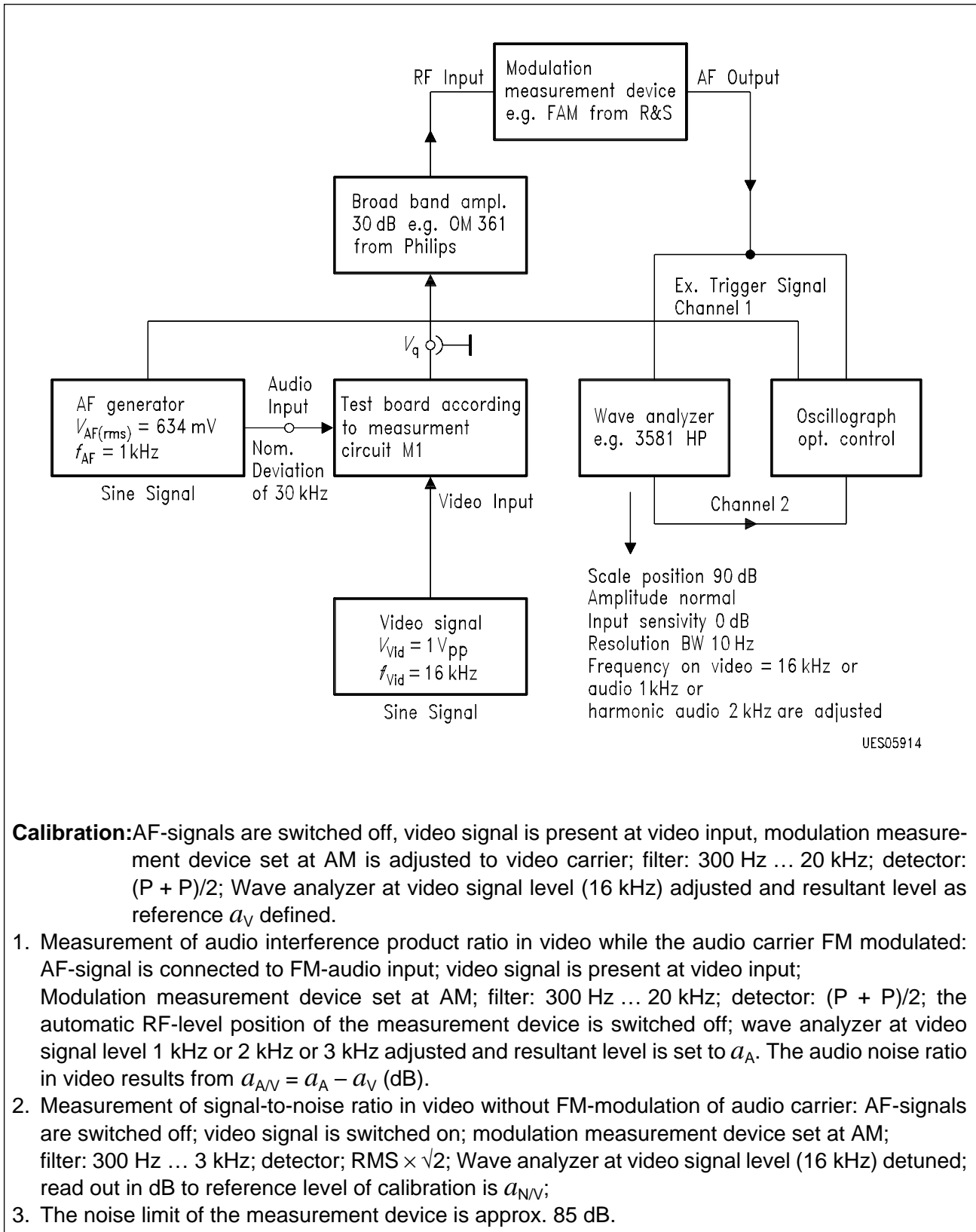

**Test Circuit 4**

**Description of the Measurement Configuration to Measure the Audio and/or Noise in Video during FM- and AM-Modulation of the Audio Carrier**



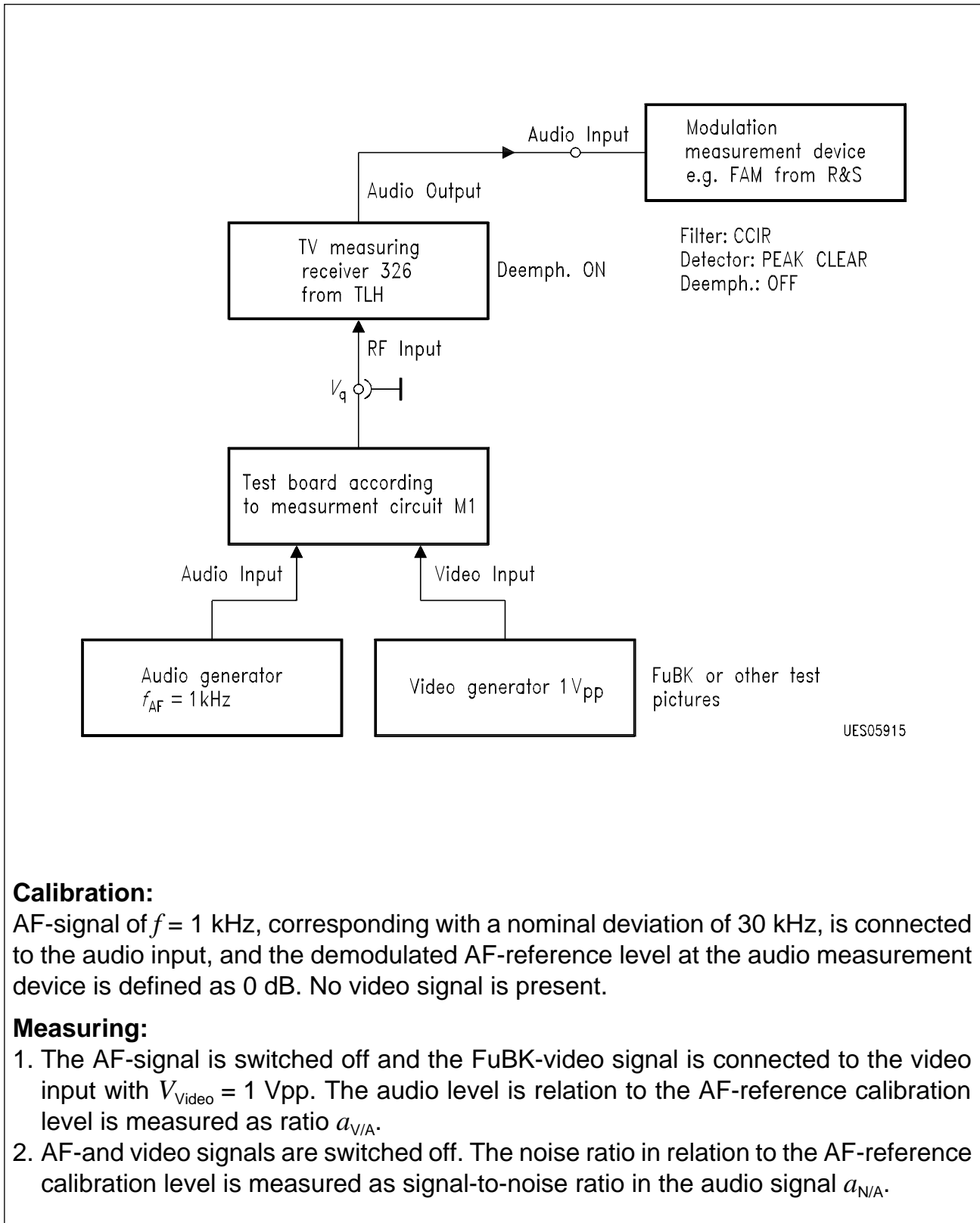

**Calibration:**

AF-signal of  $f = 1 \text{ kHz}$ , corresponding with a nominal deviation of 30 kHz, is connected to the audio input, and the demodulated AF-reference level at the audio measurement device is defined as 0 dB. No video signal is present.

**Measuring:**

1. The AF-signal is switched off and the FuBK-video signal is connected to the video input with  $V_{\text{video}} = 1 V_{pp}$ . The audio level in relation to the AF-reference calibration level is measured as ratio  $a_{V/A}$ .
2. AF-and video signals are switched off. The noise ratio in relation to the AF-reference calibration level is measured as signal-to-noise ratio in the audio signal  $a_{N/A}$ .

**Test Circuit 5**

**Description of the Measurement Configuration to Measure the Video and or Noise in Audio**

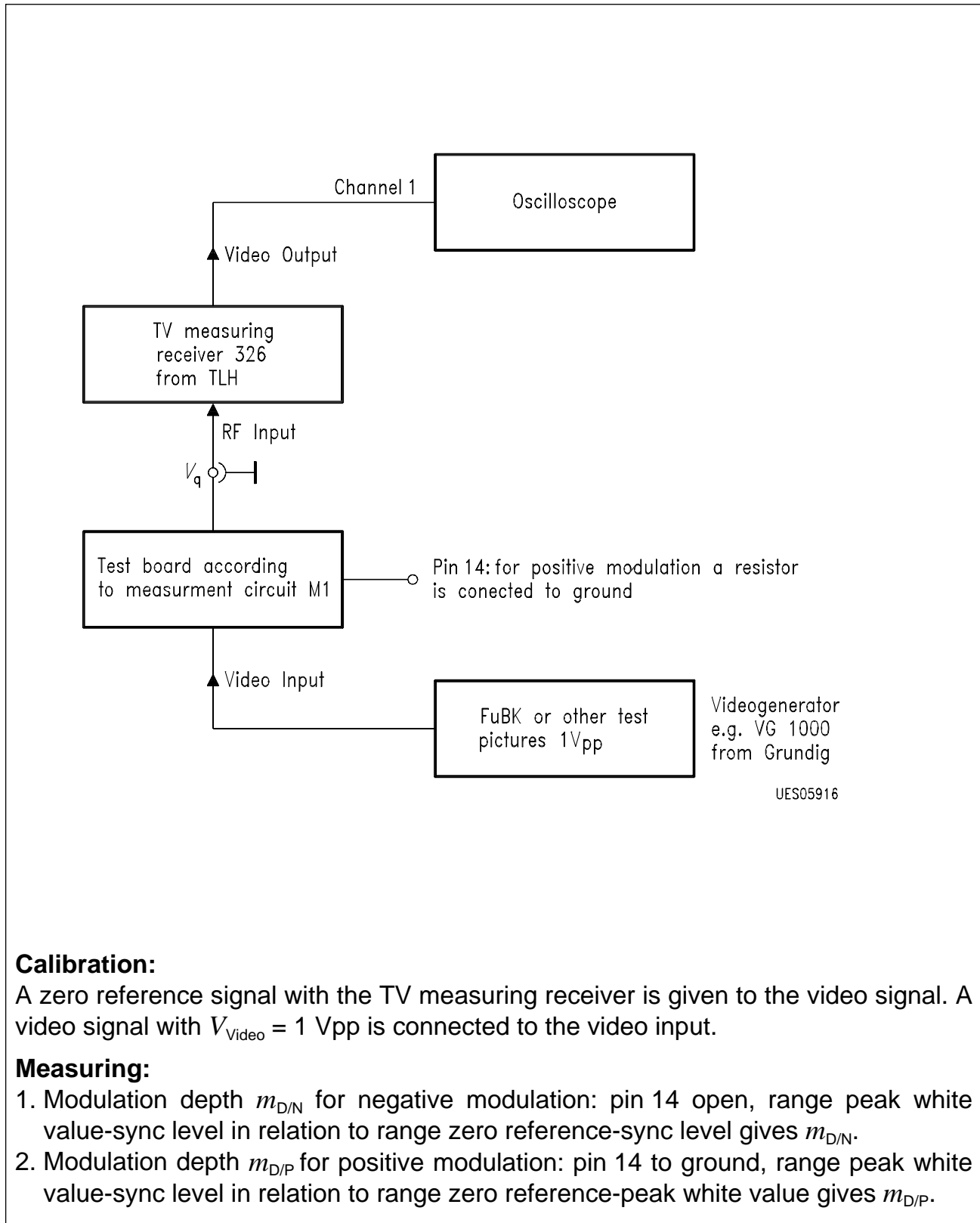

**Calibration:**

A zero reference signal with the TV measuring receiver is given to the video signal. A video signal with  $V_{\text{video}} = 1 \text{ Vpp}$  is connected to the video input.

**Measuring:**

1. Modulation depth  $m_{D/N}$  for negative modulation: pin 14 open, range peak white value-sync level in relation to range zero reference-sync level gives  $m_{D/N}$ .
2. Modulation depth  $m_{D/P}$  for positive modulation: pin 14 to ground, range peak white value-sync level in relation to range zero reference-peak white value gives  $m_{D/P}$ .

**Test Circuit 6**

**Description of the Measurement Configuration to Measure the Modulation Depth for Positive and Negative Modulation**

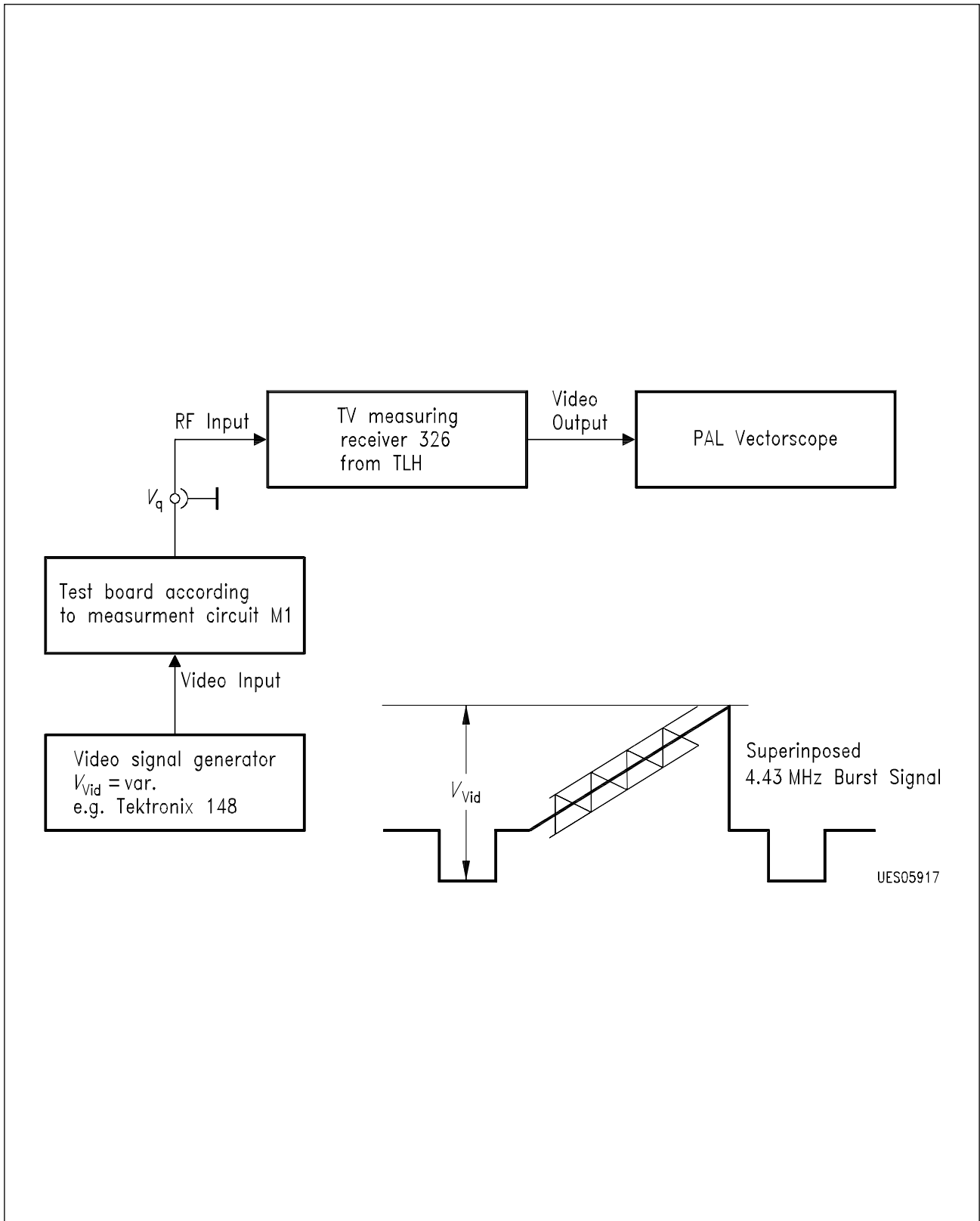

**Test Circuit 7**  
**Description of the Measurement Configuration to Measure the Differential Gain and Phase**

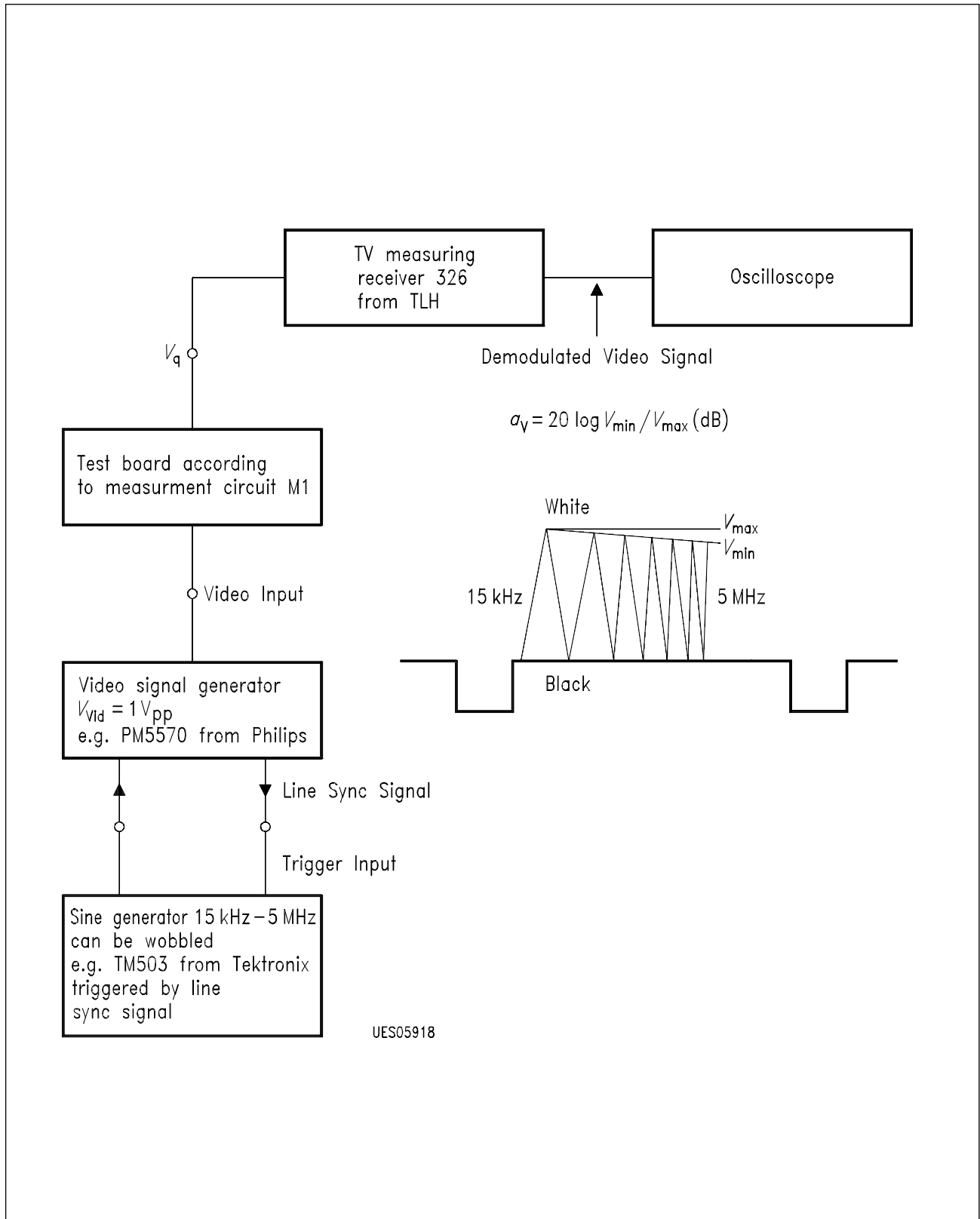

**Test Circuit 8**  
**Description of the Measurement Configuration to Measure the Video Amplitude Response**

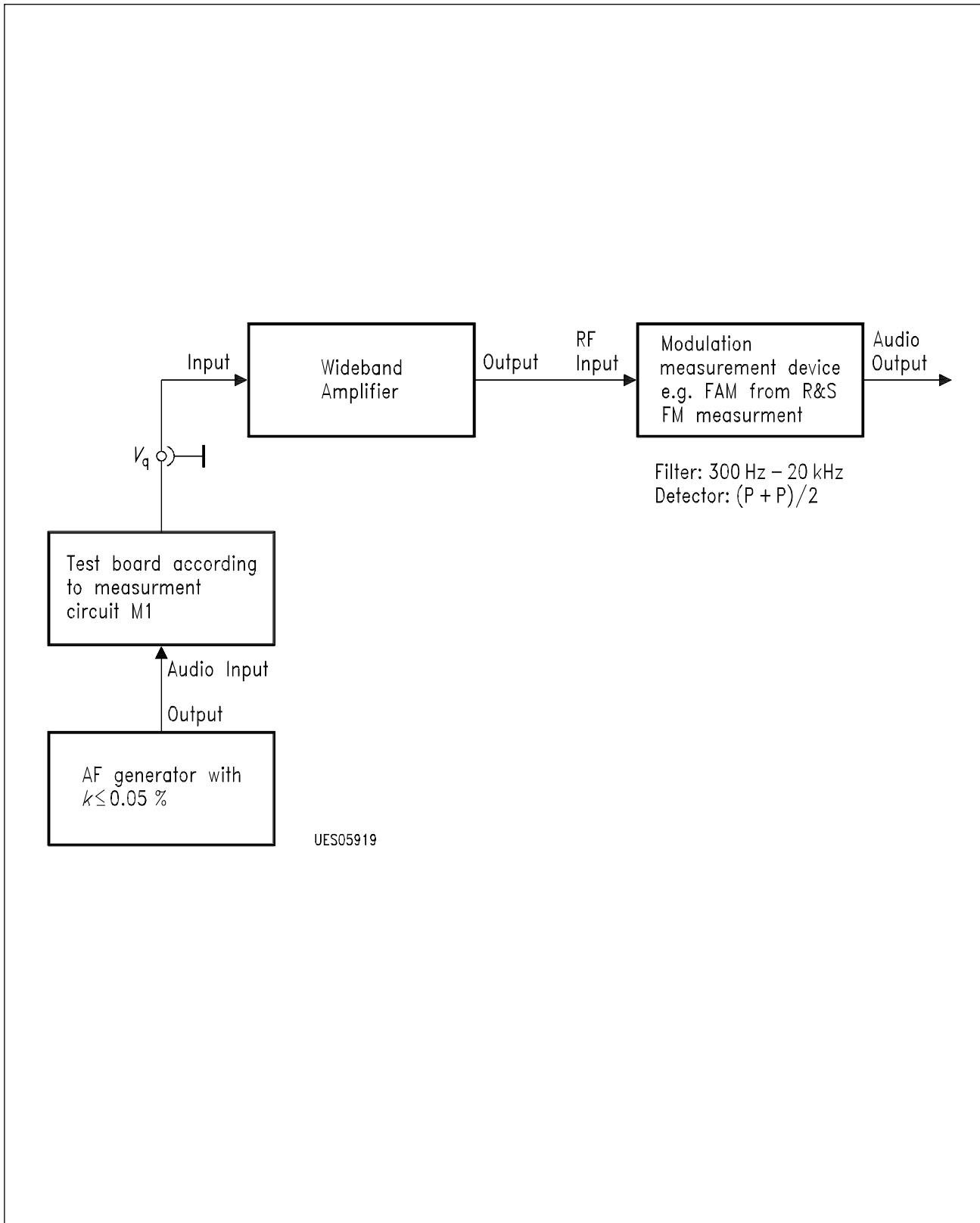

**Test Circuit 9**  
**Description of the Measurement Configuration to Measure the Harmonic Distorsion Factor and AM-Input Voltage**

Diagram

Function of Video Signal Connection.

- a) Demodulated RF-output video signal  $V_{15/17\text{rms}} = f(V_{12\text{rms}}); f_{\text{mod}} = 16 \text{ kHz}$
- b)  $V_{13} = f(V_{12\text{rms}})$

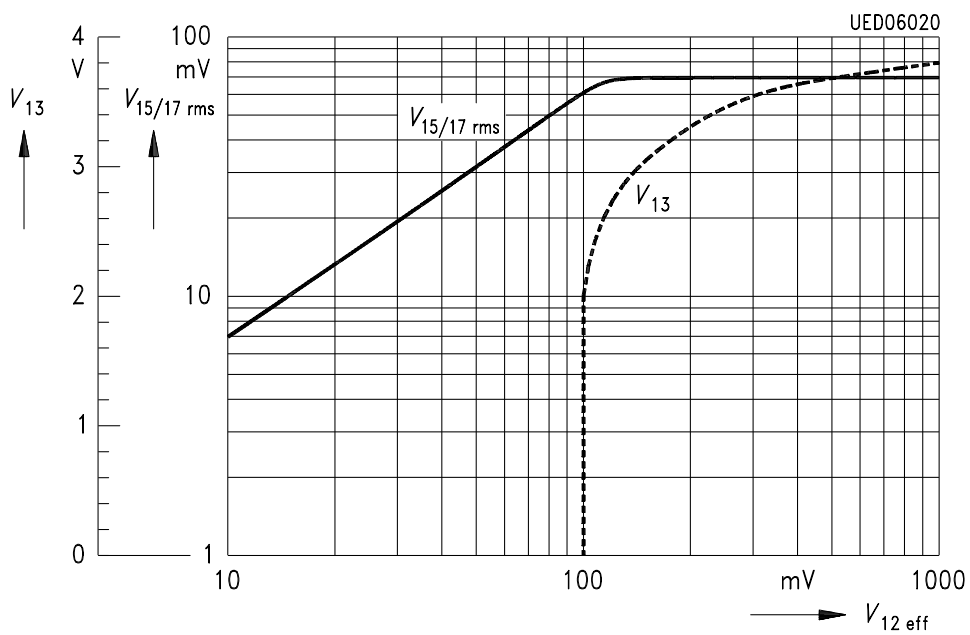

**Plastic Package, P-DSO-20-1 (SMD)**  
 (Plastic Dual Small Outline)

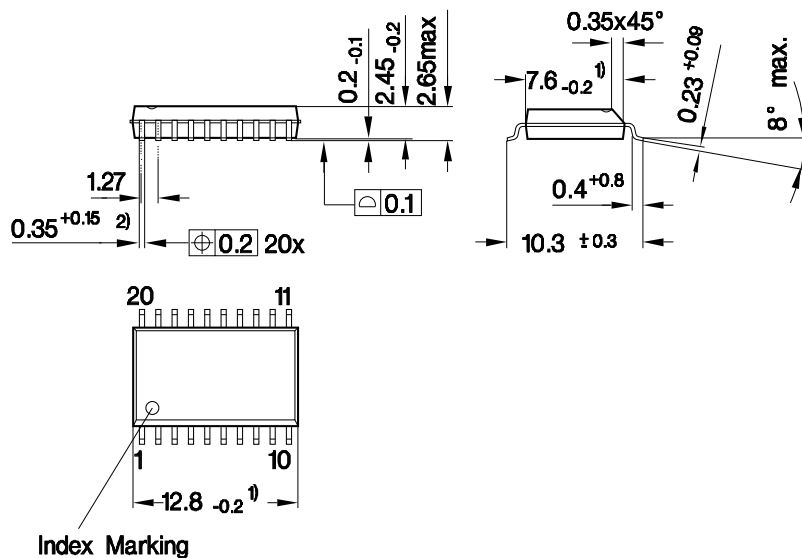

- 1) Does not include plastic or metal protrusion of 0.15 max. per side
- 2) Does not include dambar protrusion of 0.05 max. per side

GPS05094

**Sorts of Packing**

Package outlines for tubes, trays etc. are contained in our Data Book "Package Information"

SMD = Surface Mounted Device

Dimensions in mm