

FEATURES

- High Current Transfer Ratio 500% at 50 mA Output
- High Collector to Emitter Breakdown Voltage: 80 V Min.
- High Isolation Voltage $V_{ISO}=5300 \text{ VAC}_{RMS}$
- Base Lead Not Connected
- Solid State Reliability
- Standard DIP Package
- Underwriters Lab File #E52744
-  VDE 0884 Available with Option 1

DESCRIPTION

The MOC8050 is an optically coupled isolator with a Gallium Arsenide infrared emitter and a silicon photodarlington sensor. Switching can be achieved while maintaining a high degree of isolation between driving and load circuits, with no cross talk between channels. These optocouplers can be used to replace reed and mercury relays with advantages of long life, high speed switching and elimination of magnetic fields.

Maximum Ratings

Emitter

Peak Reverse Voltage 3 V
 Continuous Forward Current 60 mA
 Power Dissipation at 25°C 100 mW
 Derate Linearly from 25°C 1.33 mW/°C

Detector

Collector-Emitter Reverse Voltage 80 V
 Collector Load Current 125 mA
 Power Dissipation at 25°C Ambient 150 mW
 Derate Linearly from 25°C 2.0 mW/°C

Package

Total Package Dissipation at 25°C 250 mW
 Derate Linearly from 25°C 3.3 mW/°C
 Isolation Test Voltage 5300 VAC_{RMS}
 Isolation Resistance
 $V_{IO}=500 \text{ V}, T_A=25^\circ\text{C}$ $10^{12} \Omega$
 $V_{IO}=500 \text{ V}, T_A=100^\circ\text{C}$ $10^{11} \Omega$
 Creepage Path 8 mm min.
 Clearance Path 7 mm min.
 Comparative Tracking Index 175
 Storage Temperature Range -55°C to +125°C
 Operating Temperature Range -55°C to +100°C
 Lead Soldering Time at 260°C 10 sec.

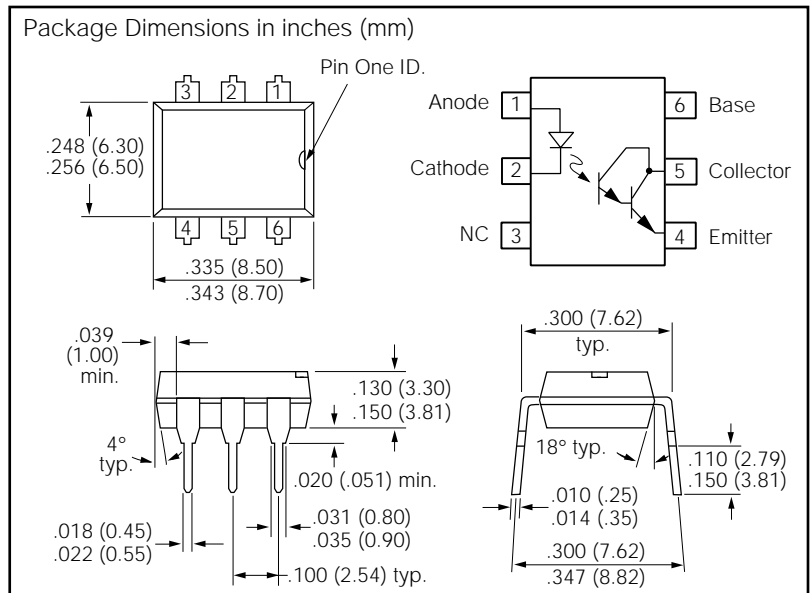

Electrical Characteristics ($T_A=25^\circ\text{C}$)

Parameter	Symbol	Min.	Typ.	Max.	Unit	Condition
Emitter						
Forward Voltage	V_F		1.25	1.5	V	$I_F=20 \text{ mA}$
Reverse Current	I_R		0.1	10	μA	$V_R=3.0 \text{ V}$
Capacitance	C_O		25		pF	$V_R=0$
Detector						
Collector-Emitter Breakdown Voltage	BV_{CEO}	80			V	$I_C=10 \mu\text{A}$
Collector-Emitter Leakage Current	I_{CEO}		25	1000	nA	$V_{CE}=60 \text{ V}$ $I_F=0$
Emitter-Collector Breakdown Voltage	V_{ECO}	5.0	8.0		V	$I_C=10 \mu\text{A}$
Package						
Current Transfer Ratio	CTR	500			%	$I_F=10 \text{ mA}$ $V_{CE}=1.5 \text{ V}$
Collector-Emitter Saturation Voltage	V_{CEsat}		0.9	1.0	V	$I_C=50 \text{ mA}$ $I_F=50 \text{ mA}$
Isolation Test Voltage	V_{ISO}	5300			VAC _{RMS}	1 sec., 60 Hz
Coupling Capacitance	C_{ISOL}		0.5		pF	
Rise Time	T_r		10		μs	$V_{CC}=13.5 \text{ V}$ $I_F=50 \text{ mA}$
Fall Time	T_f		35		μs	$R_L=100 \Omega$

Figure 1. Forward voltage vs. forward current

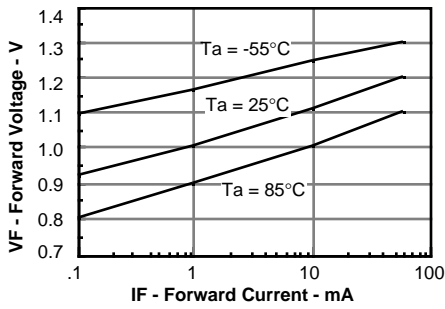

Figure 5. Typical Ic vs. Vce (sat. region)

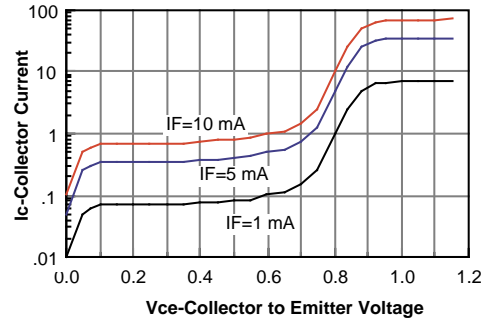

Figure 2. Typical Ic vs. Vce

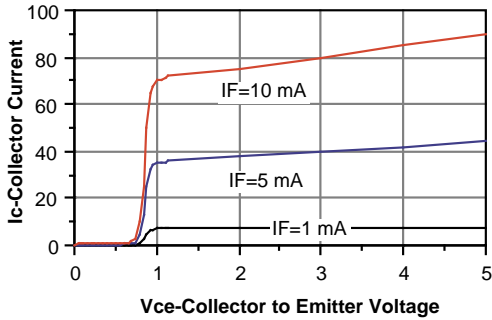

Figure 6. Typical Ico vs. temperature

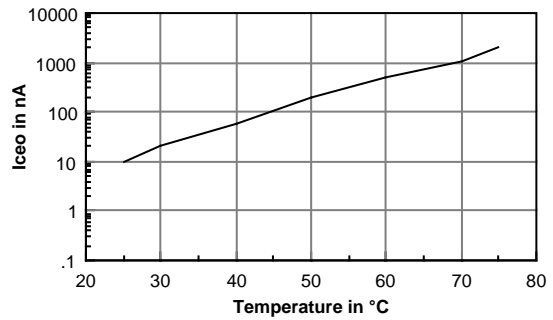

Figure 3. Typical Ic vs. Vce vs. temperature

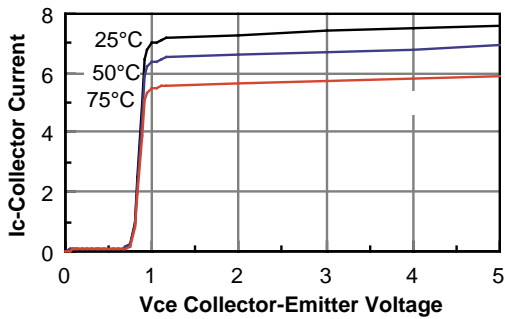

Figure 7. Low to high propagation delay vs. collector load resistance and LED current

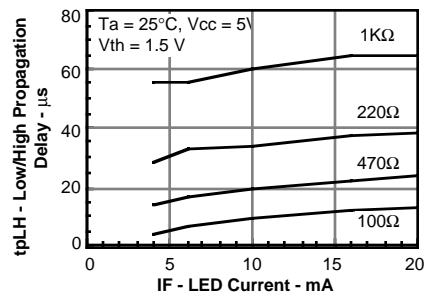

Figure 4. Typical NCTR vs. LED current

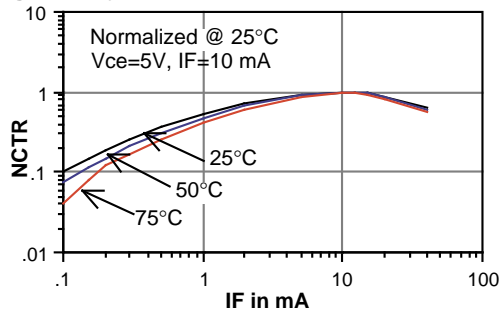

Figure 8. High to low propagation delay vs. collector load resistance and LED current

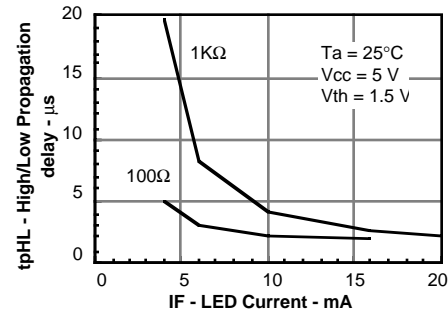

Figure 9. Switching waveform

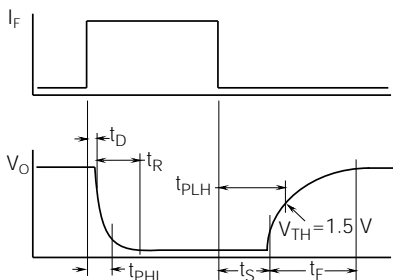

Figure 10. Switching schematic

