

## PNP Silicon Darlington Transistors

**PZTA 63**  
**PZTA 64**

- For general AF applications
- High collector current
- High current gain
- Complementary types: PZTA 13, PZTA 14 (NPN)

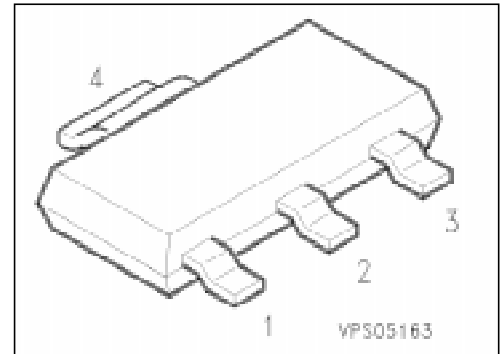

Type	Marking	Ordering Code (tape and reel)	Pin Configuration				Package <sup>1)</sup>
			1	2	3	4	
PZTA 63 PZTA 64	PZTA 63 PZTA 64	Q62702-Z2031 Q62702-Z2032	B	C	E	C	SOT-223

### Maximum Ratings

Parameter	Symbol	Values	Unit
Collector-emitter voltage	$V_{CES}$	30	V
Collector-base voltage	$V_{CB0}$	30	
Emitter-base voltage	$V_{EB0}$	10	
Collector current	$I_C$	500	mA
Peak collector current	$I_{CM}$	800	
Base current	$I_B$	100	
Peak base current	$I_{BM}$	200	
Total power dissipation, $T_s = 124\text{ °C}$	$P_{tot}$	1.5	W
Junction temperature	$T_j$	150	°C
Storage temperature range	$T_{stg}$	- 65 ... + 150	

### Thermal Resistance

Junction - ambient <sup>2)</sup>	$R_{th\ JA}$	≤ 72	K/W
Junction - soldering point	$R_{th\ JS}$	≤ 17	

<sup>1)</sup> For detailed information see chapter Package Outlines.

<sup>2)</sup> Package mounted on epoxy pcb 40 mm × 40 mm × 1.5 mm/6 cm<sup>2</sup> Cu.

## Electrical Characteristics

at  $T_A = 25\text{ °C}$ , unless otherwise specified.

Parameter	Symbol	Values			Unit
		min.	typ.	max.	

### DC characteristics

Collector-emitter breakdown voltage $I_C = 100\text{ }\mu\text{A}$	$V_{(BR)CES}$	30	–	–	V
Collector-base breakdown voltage $I_C = 100\text{ }\mu\text{A}, I_B = 0$	$V_{(BR)CB0}$	30	–	–	
Emitter-base breakdown voltage $I_E = 10\text{ }\mu\text{A}, I_C = 0$	$V_{(BR)EB0}$	10	–	–	
Collector-base cutoff current $V_{CE} = 30\text{ V}, I_E = 0$ $V_{CE} = 30\text{ V}, I_E = 0, T_A = 150\text{ °C}$	$I_{CB0}$	–	–	100 10	nA $\mu\text{A}$
Emitter-base cutoff current $V_{EB} = 10\text{ V}, I_C = 0$	$I_{EB0}$	–	–	100	nA
DC current gain $I_C = 10\text{ mA}, V_{CE} = 5\text{ V}$ $I_C = 100\text{ mA}, V_{CE} = 5\text{ V}$	$h_{FE}$	PZTA 63 PZTA 64 PZTA 63 PZTA 64	5000 10000 10000 20000	– – – –	–
Collector-emitter saturation voltage <sup>1)</sup> $I_C = 100\text{ mA}, I_B = 0.1\text{ mA}$	$V_{CEsat}$	–	–	1.5	V
Base-emitter saturation voltage <sup>1)</sup> $I_C = 100\text{ mA}, I_B = 0.1\text{ mA}$	$V_{BEsat}$	–	–	2.0	

### AC characteristics

Transition frequency $I_C = 50\text{ mA}, V_{CE} = 5\text{ V}, f = 100\text{ MHz}$	$f_T$	125	–	–	MHz
---	-------	-----	---	---	-----

<sup>1)</sup> Pulse test conditions:  $t \leq 300\text{ }\mu\text{s}, D = 2\%$ .

**Total power dissipation  $P_{tot} = f(T_A^*; T_S)$**

\* Package mounted on epoxy

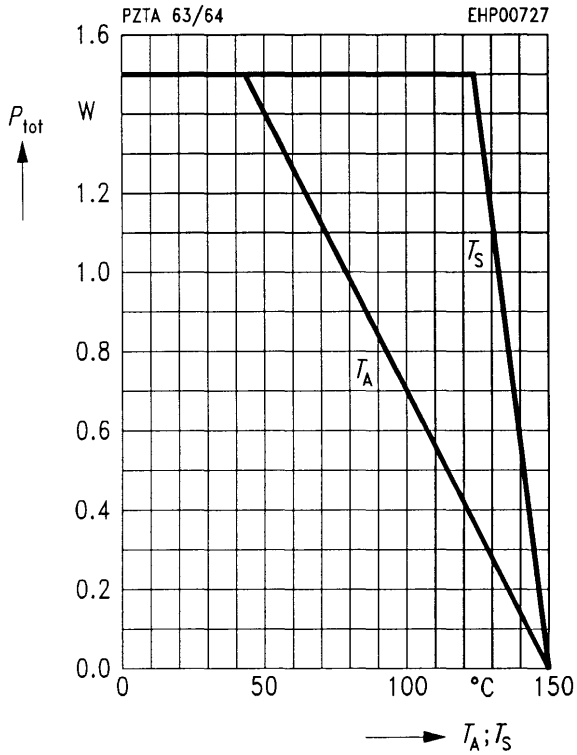

**Transition frequency  $f_T = f(I_C)$**

$V_{CE} = 5 V, f = 100 \text{ MHz}$

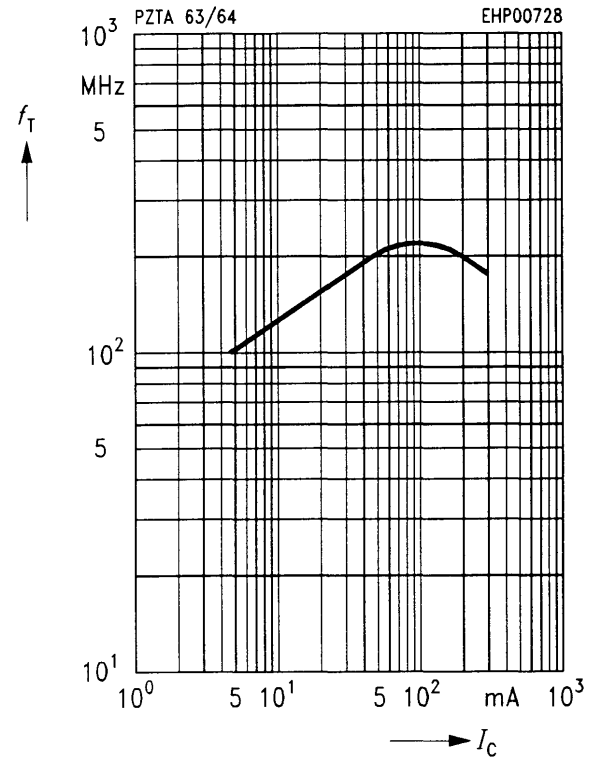

**Permissible pulse load  $P_{tot \text{ max}} / P_{tot \text{ DC}} = f(t_p)$**

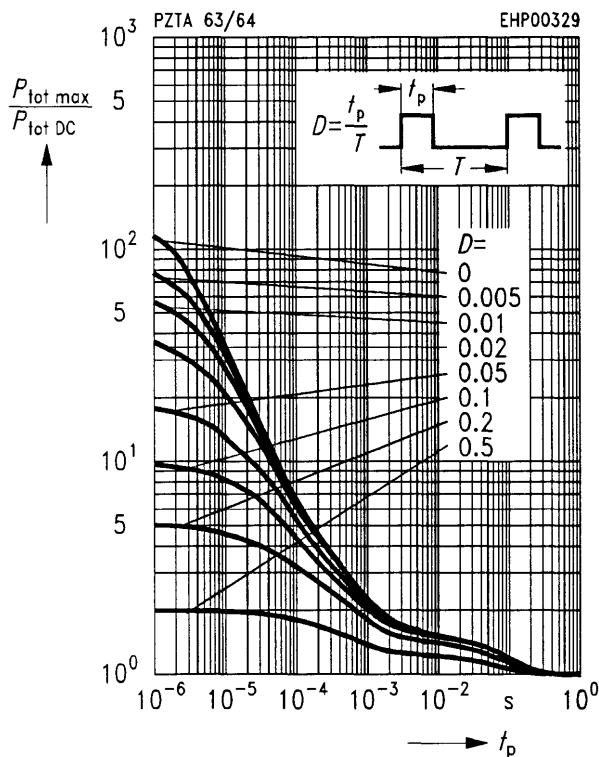

**DC current gain  $h_{FE} = f(I_C)$**

$V_{CE} = 5 V$

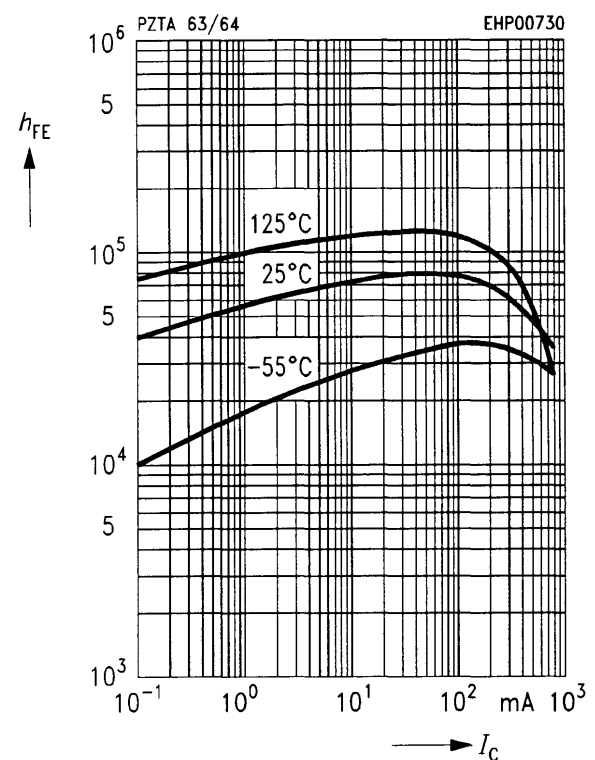

**Collector-emitter saturation voltage**

$I_C = f(V_{CE\ sat})$

$h_{FE} = 1000$

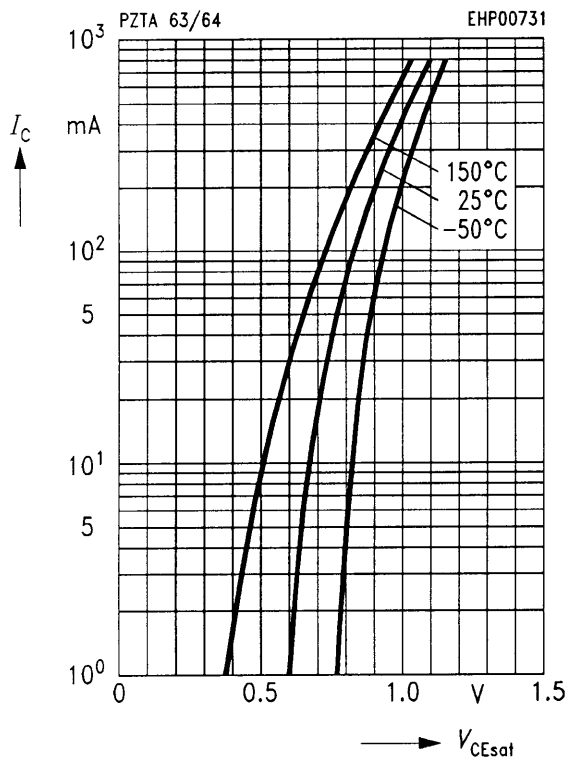

**Base-emitter saturation voltage**

$I_C = f(V_{BE\ sat})$

$h_{FE} = 1000$

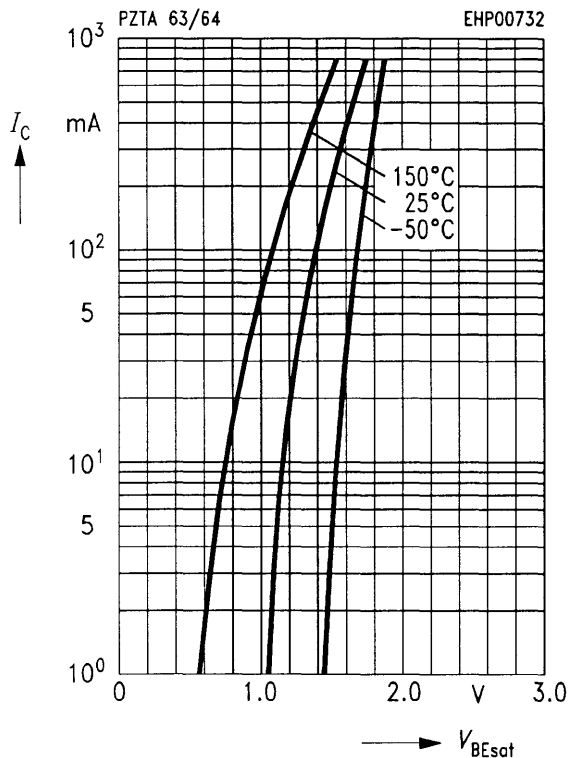

**Collector cutoff current  $I_{CB0} = f(T_A)$**

$V_{CE} = 30\ V$

